

Australian Disaster Resilience Handbook Collection

This manual is no longer current. It has been archived. This manual will not be reviewed and should be used for historical reference only.

For further information please refer to AFAC Doctrine



Australian Institute for
Disaster Resilience



SKILLS FOR EMERGENCY SERVICES PERSONNEL

A large circular graphic composed of eight red triangles pointing towards the center, creating a white star-like shape. The text is centered within this graphic.

General
and
Disaster Rescue
Fifth Edition

AUSTRALIAN EMERGENCY
MANUAL SERIES

SKILLS FOR EMERGENCY SERVICES PERSONNEL

GENERAL AND DISASTER RESCUE

Fifth Edition

MANUAL NUMBER 35

COPYRIGHT

Permission to use the document and related graphics is granted provided that (1) the below copyright notice appears in all copies and that both the copyright notice and this permission notice appear, and (2) use of document and related graphics is for educational, informational and non-commercial or personal use only.

In all cases the Commonwealth of Australia must be acknowledged as the source when reproducing or quoting any part of this publication. Examples and quotations from other sources have been attributed to the original publication whenever possible and are believed to fall within fair use provisions, but these portions retain their copyright protection and must not be used without attribution.

Enquiries related to copyright should be addressed to:
The Director General
Emergency Management Australia
PO BOX 1020
Dickson ACT 2602
Or telephone (02) 6256 4600 or fax (02) 6256 4653 or email ema@ema.gov.au

Any rights not expressly granted herein are reserved.

DISCLAIMER

This publication is presented by Emergency Management Australia for the purpose of disseminating emergency management information free of charge to individuals who provide professional training and supervision to members of professional organisations in the field of emergency management. Professional organisations include, but are not limited to, professional firefighters, trained emergency services volunteers, and members of State/Territory police and rescue organisations whose members have training and basic competencies in emergency management services.

The information in this publication is not intended to be used by the general public or untrained persons, and is not a substitute for professional advice and/or training. Untrained persons should not use this publication unless a trained and qualified emergency management professional supervises them and/or their training in the subjects listed in the publication.

Emergency Management Australia, in consultation with emergency management professionals and subject matter experts, exercises care in the compilation and drafting of this publication; however, the document and related graphics could include technical inaccuracies or typographical errors and the information provided may not be appropriate to all situations. In no event shall the Commonwealth of Australia (acting through Emergency Management Australia) be liable for any damages whatsoever, whether in an action of contract, negligence or other tortious action, arising out of or in connection with the use of or reliance on any of the information presented in this publication.

Emergency Management Australia periodically updates the information in this publication. Before using this publication, please check with the training officer in the State Emergency Services organisation in your State/Territory to ensure that this edition is the most recent and updated version of the publication.

INTELLECTUAL PROPERTY STATEMENT

In contributing to the development of this manual, it is acknowledged that no ongoing rights to the information are retained by individual contributors. The information contained within this manual is not owned by individuals or State/Territory organisations but is held in trust by the Commonwealth on behalf of the Australian community. The information contained within this manual is current as at August 2006.

© Commonwealth of Australia 2006
First published 1984
Second edition 1988
Third edition 1989
Fourth edition 1997
Fifth edition 2006
ISBN 1 921152 02 8

The Australian Emergency Manual Series

The first publication in the original Australian Emergency Manual (AEM) Series of mainly skills reference manuals was produced in 1989. In August 1996, on advice from the National Emergency Management Principles and Practice Advisory Group, Emergency Management Australia (EMA) agreed to expand the AEM Series to include a more comprehensive range of emergency management principles and practice reference publications.

The AEM Series has been developed to assist in the management and delivery of support services in a disaster context. It comprises principles, strategies and actions compiled by practitioners with management and service delivery experience in a range of disaster events.

The series has been developed by a national consultative committee representing a range of State and Territory agencies involved in the delivery of support services and is sponsored by EMA.

Details of the AEM Series are available on the EMA website, under publications, at www.ema.gov.au. These manuals are also available free of charge on CD. Please send requests to ema@ema.gov.au.

AUSTRALIAN EMERGENCY MANUAL SERIES STRUCTURE AND CONTENT

PRINCIPLES AND REFERENCE SERIES

Manual 2	Australian Emergency Management Arrangements
Manual 3	Australian Emergency Management Glossary
Manual 4	Australian Emergency Management Terms Thesaurus
Manual 18	Community and Personal Support Services
Manual 29	Community Development in Recovery from Disaster
Manual 15	Community Emergency Planning
Manual 27	Disaster Loss Assessment Guidelines
Manual 9	Disaster Medicine
Manual 28	Economic and Financial Aspects of Disaster Recovery
Manual 8	Emergency Catering
Manual 1	Emergency Management Concepts and Principles
Manual 23	Emergency Management Planning for Floods Affected by Dams
Manual 5	Emergency Risk Management—Applications Guide
Manual 43	Emergency Planning
Manual 11	Evacuation Planning
Manual 20	Flood Preparedness
Manual 22	Flood Response
Manual 21	Flood Warning
Manual 25	Guidelines for Psychological Services: Emergency Managers Guide
Manual 26	Guidelines for Psychological Services: Mental Health Practitioners Guide
Manual 13	Health Aspects of Chemical, Biological and Radiological Hazards
Manual 6	Implementing Emergency Risk Management—A facilitators guide to working with committees and communities
Manual 42	Managing Exercises
Manual 19	Managing the Floodplain
Manual 17	Multi-Agency Incident Management
Manual 31	Operations Centre Management
Manual 7	Planning Safer Communities—Land use Planning for Natural Hazards
Manual 14	Post Disaster Survey and Assessment
Manual 10	Recovery
Manual 24	Reducing the Community Impact of Landslides
Manual 12	Safe and Healthy Mass Gatherings
Manual 41	Small Group Training Management
Manual 16	Urban Search and Rescue—Capability Guidelines for Structural Collapse

SKILLS FOR EMERGENCY SERVICES PERSONNEL SERIES

Manual 38	Communications
Manual 39	Flood Rescue Boat Operation
Manual 37	Four Wheel Drive Vehicle Operation
Manual 35	General and Disaster Rescue
Manual 33	Land Search Operations (no longer available)
Manual 32	Leadership
Manual 36	Map Reading and Navigation
Manual 34	Road Accident Rescue
Manual 30	Storm and Water Damage Operations
Manual 40	Vertical Rescue

Archived

Foreword

Disasters and emergencies in Australia have resulted in significant physical, economic, social and psychological costs, which in turn have placed pressures on communities and businesses. The estimated annual cost of disasters in this country, including the social impact, is at least \$3 billion.

The reality is that disasters and emergencies, both small and large, are a part of life and will continue to occur, whether natural or caused by humans. Australians need to learn from these events, be better prepared and be more proactive towards building resilience into our communities.

The dynamic nature of emergencies continually challenges emergency management personnel. The *Skills for Emergency Services Personnel* series is a group of national best-practice manuals that provide the fundamental technical principles from which the state and territory emergency services can customise their application.

This fifth edition of the AEM *General and Disaster Rescue* (previously called *General Rescue*), in the *Skills for Emergency Services Personnel* series, provides a basic reference for rescue operations. It is intended to cover basic and general equipment, systems and techniques rather than any specialised skill, and is designed for use by emergency management personnel in planning, training and operations. *General and Disaster Rescue* also provides the fundamental skills and knowledge for undertaking other specialised skills covered in the *Skills for Emergency Services Personnel* series.

Rescue, by its very nature, is a high-risk activity. EMA accepts no responsibility for any accident or injury caused by misuse or misinterpretation of information contained in this manual. Reading this manual alone cannot be considered adequate training for rescuers. Knowledge must be linked with training, practical experience and strict adherence to safety standards and procedures.

The use of trade or brand names in this manual is not intended to be restrictive, preferential or promotional. Rather, trade names are used where descriptive clarity is required.

I would like to thank the State Emergency Service National Education and Training Committee (SES NETC) for coordinating this review and for ensuring current national best practice in rescue skills. As situations change, and improved techniques are developed, the manual will be updated and amended under the auspices of the SES NETC. Suggestions for changes should be forwarded to EMA at the address shown below.

Tony Pearce
Director General
Emergency Management Australia
October 2006

Emergency Management Australia, PO Box 1020, Dickson ACT 2602

Archived

Contents

Chapter 1

Rescue Organisation, Planning and Equipment

1.1	The Aim of Rescue	1
1.2	Functions.....	1
1.3	The Psychology of Rescue.....	1
1.4	Rescue Workers	1
1.4.1	Group 1—Survivors	1
1.4.2	Group 2—Untrained Personnel	2
1.4.3	Group 3—Trained Personnel	2
1.5	Personal Traits of the Rescuer	2
1.6	Personal Behaviour	3
1.7	Team Composition.....	3
1.8	The Rescue Plan.....	3
1.9	The Reconnaissance.....	3
1.10	The Appreciation Process	4
1.11	Operational Orders.....	5
1.11.1	Orders Format	5
1.12	Continuing Action	5
1.13	Urban Search and Rescue (USAR) Training.....	6
1.14	Rescue by Phases	6
1.14.1	Phase 1—Reconnaissance and Survey	6
1.14.2	Phase 2—Elimination of Utilities (Risk Assessment and Controls).....	6
1.14.3	Phase 3—Primary Surface Search and Rescue.....	6
1.14.4	Phase 4—Exploration of all Voids	7
1.14.5	Phase 5—Access by Selected Debris Removal	7
1.14.6	Phase 6—Terminate by General Debris Removal	7
1.15	INSARAG Incident Marking Systems.....	7
1.15.1	Site Identification Marking System.....	7
1.15.2	Structural Assessment and Search Marking System.....	9
1.15.3	Victim Marking System	11
1.16	Location Techniques.....	13
1.16.1	Line and Hail Search Technique	14
1.16.2	Conducting a Line and Hail Search	14
1.16.3	Actions Upon Hearing a Victim	15
1.16.4	Action Upon Establishing Contact with a Victim	15

Chapter 2

Safety in Training and Operations

2.1	Introduction.....	17
2.2	Basic Precautions.....	17
2.3	Protective Clothing and Safety	18
2.4	Rescue/Safety Harnesses.....	18
2.5	Casualty Safety	18
2.6	Safe Working in a Confined Space	19
2.7	Vehicle Safety.....	19
2.8	Equipment Safety	20
2.9	Public Utility Hazards	20

2.9.1	General	20
2.9.2	Gas [Domestic and Liquefied Petroleum Gas (LPG)]	20
2.9.3	Water	21
2.9.4	Sewers	21
2.9.5	Electricity	21
2.10	The Responsibility for Safety	22
2.11	Correct Lifting Techniques	23
2.11.1	Team Lifting	23

Chapter 3

Fires and Elementary Firefighting

3.1	Responsibility for Firefighting	25
3.2	What is Fire?	25
3.3	Classes of Fire and Methods of Extinguishment	25
3.3.1	Firefighting Agents	27
3.4	Fire Extinguishers	28
3.4.1	Types of Fire Extinguishers	29
3.4.2	Extinguisher Rating Markings	30
3.4.3	Rating Tests for Extinguishers	31
3.4.4	Use and Operation of Extinguishers	31
3.5	Priorities During a Fire or Emergency	33
3.6	First-attack Fire Response Procedures	34
3.7	Working and Moving in Smoke	35
	Annex 'A'—portable Fire Extinguisher/fire Blanket Selection Chart	36

Chapter 4

Ropes, Chains And Slings

4.1	Introduction	37
4.2	Record Systems	37
4.3	Rope	37
4.4	Types Of Rope	37
4.5	Terminology	38
4.6	Synthetic Fibre Rescue Rope	39
4.6.1	Construction	39
4.6.2	Polyamide (Nylon)	40
4.6.3	Plasma	40
4.6.4	Kernmantel Construction	40
4.6.5	Static Kernmantel Ropes	40
4.6.6	Characteristics Of A Synthetic Fibre Static Rescue Rope	41
4.6.7	Care And Maintenance	42
4.6.8	Washing Ropes	43
4.6.9	Inspection	43
4.6.10	Retiring A Rope	43
4.6.11	Identification	44
4.6.12	Rated Strength and SWL	44
4.6.13	Rope Packaging	44
4.6.14	Carrying the Rope	46
4.6.15	Flaking the Rope	46
4.7	11mm Polyamide Dynamic Climbing Ropes	46
4.8	Small Diameter Kernmantel Cords	46

4.9	Climbing Tape.....	46
4.9.1	Construction.....	47
4.9.2	Size.....	47
4.9.3	Abrasion.....	47
4.9.4	The Use of Tape.....	47
4.9.5	Care and Maintenance	48
4.9.6	Safety.....	48
4.10	Other Synthetic Fibre Ropes.....	49
4.10.1	Materials	49
4.10.2	Rated Strength and SWL.....	49
4.10.3	Care, Maintenance and Safe Operations	49
4.11	Natural Fibre Ropes	49
4.11.1	Materials	49
4.11.2	Construction.....	49
4.11.3	Care and Maintenance	50
4.11.4	Inspection of Laid Rope.....	51
4.11.5	Rated Strength and SWL.....	51
4.11.6	Rope Packaging	52
4.11.7	Whipping Rope Ends	52
4.12	Flexible Steel Wire Rope.....	53
4.12.1	Construction.....	53
4.12.2	Safe Working Loads.....	53
4.12.3	Precautions in Operations	53
4.12.4	Inspection of SWRs	53
4.12.5	Storage of SWRs	54
4.13	Chains.....	54
4.14	Slings	55
4.14.1	Inspection of Slings	55
4.14.2	Precautions In Operations.....	55
4.14.3	Sling Loading Angles	56

Chapter 5

Knots and Lashings

5.1	Introduction.....	57
5.2	Knots for Synthetic Fibre Rescue Ropes (AS 4142.3)	57
5.2.1	Thumb Knot	57
5.2.2	Figure of Eight Knot.....	58
5.2.3	Figure of Eight Loop/Figure of Eight on the Bight.....	58
5.2.4	Alpine Butterfly.....	59
5.2.5	Round Turn and Two Half-hitches.....	59
5.2.6	Tensionless Hitch.....	59
5.2.7	Italian/munter Hitch.....	60
5.2.8	Double Fisherman's Knot.....	60
5.2.9	Prusik Knot	60
5.2.10	Tape Knot.....	61
5.3	Knots for General Purpose Ropes	61
5.3.1	Half-hitch.....	61
5.3.2	Clove Hitch	61
5.3.3	Timber Hitch.....	62
5.3.4	Fisherman's Bend.....	62
5.3.5	Buntline Hitch.....	63

5.3.6	Double Sheet Bend.....	63
5.3.7	Bowline	63
5.3.8	Bowline on the Bight	64
5.3.9	Portuguese Bowline	64
5.3.10	Chair Knot.....	65
5.4	Knot Safety.....	65
5.5	Knot Strengths.....	66
5.6	Lashings.....	67
5.6.1	Terminology	67
5.6.2	Square Lashing.....	67
5.6.3	Diagonal Lashing.....	67
5.6.4	Round Lashing.....	68
5.6.5	Figure of Eight Lashing.....	68

Chapter 6

Ladders

6.1	Introduction.....	69
6.2	Terminology.....	69
6.3	Construction	69
6.4	Types of Ladders.....	69
6.4.1	Straight Ladders	69
6.4.2	Extension Ladders	70
6.4.3	Folding Ladders	71
6.5	Using Ladders	71
6.5.1	Single-rescuer Ladder Raise	71
6.5.2	Erecting and Extending the Ladder (Three Rescuers)	72
6.5.3	Erecting and Extending the Ladder (Two Rescuers)	72
6.5.4	Angle of Ladders when Raised.....	72
6.5.5	Overlaps	73
6.5.6	Securing the Head of the Ladder.....	73
6.5.7	Securing the Foot of the Ladder	73
6.5.8	Ladder Climbing.....	73
6.5.9	Halving Ladders.....	74
6.6	Maintenance and Testing	74

Chapter 7

Casualty Handling

7.1	Introduction.....	75
7.2	Triage	75
7.3	Classification of Casualties	76
7.4	Stretchers.....	77
7.4.1	Advantages And Disadvantages.....	78
7.5	Folding or Pole Stretchers.....	78
7.5.1	Blanketing the Stretcher	78
7.5.2	Double-blanket Method	78
7.5.3	Single-blanket Method	79
7.5.4	Improvised Blanketing	80
7.5.5	Lashing the Patient to the Stretcher	80
7.5.6	Stretcher Lashing—Lateral Position	80
7.5.7	Blanketing—Lateral Position.....	81

7.5.8	Lashing—Lateral Position	81
7.6	Basket Stretchers	81
7.6.1	Blanketing a Basket Stretcher	81
7.6.2	Securing a Basket Stretcher with Securing Straps	82
7.6.3	Securing a Basket Stretcher by Lashing.....	82
7.7	Wrap-around Stretchers	83
7.8	Extrication Devices and Backboards (Spineboards)	83
7.9	Improvised Stretchers	84
7.9.1	Platform Stretchers	84
7.9.2	Pole Stretchers	84
7.9.3	Bush Stretchers	85
7.9.4	Ladders.....	85
7.9.5	Chairs	86
7.10	Loading a Stretcher.....	86
7.10.1	The Four-rescuer Method	86
7.10.2	Blanket Lift (Four or Six Rescuers).....	87
7.10.3	Log Roll and Scoop onto Backboard	88
7.10.4	Clothing Lift (Three Rescuers).....	88
7.10.5	Webbing Bands (Five Rescuers)	88
7.10.6	Specialist Lifting/Loading Devices	89
7.11	Moving Stretchers	89
7.11.1	Moving a Stretcher over Uneven Ground	89
7.11.2	Moving a Stretcher in Confined Spaces	89
7.11.3	Passing a Stretcher over a Gap.....	90
7.12	Rescue Techniques using no Equipment	90
7.13	One-Rescuer Handling Techniques.....	90
7.13.1	Single-Rescuer Human Crutch	90
7.13.2	Pick-a-back	91
7.13.3	Firefighter's Crawl.....	91
7.13.4	Removal Down Stairs Method	92
7.13.5	Helping a Casualty Down a Ladder	92
7.14	Two-Rescuer Handling Techniques.....	93
7.14.1	Two-Rescuer Human Crutch	93
7.14.2	Two-Handed Seat	93
7.14.3	Three-Handed Seat	94
7.14.4	Four-Handed Seat	94
7.14.5	The Fore and Aft Method	95

Chapter 8

Anchors And Holdfasts

8.1	Introduction.....	97
8.2	Natural Anchors.....	97
8.3	Constructed Anchors.....	97
8.3.1	Picket Holdfasts	97
8.3.2	Placement of Pickets	98
8.3.3	Picket Removal.....	98
8.3.4	Picket Lashings.....	98
8.3.5	Anchor Plates	99
8.3.6	Buried Holdfasts	99
8.3.7	Log And Picket Holdfast.....	100
8.4	Sand Anchors	101
8.5	Improvised Anchors.....	101

8.6	Precautions In Operations.....	101
8.7	Selection Of Anchors.....	102
8.8	Sling Loading Angles.....	102
8.9	Attachment To Anchors	103
8.10	Karabiners.....	103
	8.10.1 Accidental Gate Opening.....	104
	8.10.2 Concerns with Locking Karabiners	104
	8.10.3 Karabiner Usage.....	104
8.11	Shackles.....	105
	8.11.1 Safety in Operations	105
8.12	Safety Summary.....	105

Chapter 9

Pulley Systems And Winches

9.1	Pulley Systems.....	107
	9.1.1 Terminology	107
	9.1.2 Types of Pulleys.....	108
	9.1.3 Characteristics of a Lightweight Rescue Pulley	109
	9.1.4 Reeving a Pulley System.....	109
	9.1.5 Types of Pulley Systems.....	110
	9.1.6 Mechanical Advantage.....	110
	9.1.7 Improvised Hook Mousing	112
	9.1.8 Precautions In Operations	112
9.2	Lift/Lower Rope Rescue Devices	113
	9.2.1 Pulley Systems	113
	9.2.2 Drum Systems	114
	9.2.3 Operational Usage—Standard Procedures	114
9.3	Tirfor Style Winch	114
	9.3.1 The Tirfor Kit	115
	9.3.2 Precautions In Operations	115
	9.3.3 Safety Features	116
9.4	The Ratchet Winch.....	116
9.5	Vehicle-Mounted Power Winches.....	117
	9.5.1 Precautions in Operations	117
	9.5.2 The PTO Winch (Mechanical Spool).....	118
	9.5.3 The PTO Winch (Mechanical Capstan)	118
	9.5.4 The Electrically Powered Spool Winch	118

Chapter 10

Lifting/Lowering Techniques

10.1	Introduction.....	119
10.2	Mechanical Lowering Operations.....	119
	10.2.1 Precautions in Operations	120
10.3	Stretcher Operations	121
	10.3.1 Guide and Safety Lines	121
10.4	Single-Point Lower	121
	10.4.1 Improvised Single-Point Lower	121
10.5	Two-Point Vertical Suspension.....	122
10.6	Four-Point Horizontal Suspension.....	124
10.7	Ladder Hinge.....	124

10.8 Ladder Slide	126
10.9 The Jib.....	127
10.10 Diagonal Lower	128
10.11 Commercial Rescue Derricks.....	130
10.12 Improvised Rescue Derricks.....	130
10.13 The Standing Derrick.....	131
10.13.1 Anchors.....	131
10.13.2 Head Rigging	131
10.13.3 Leading Pulley	131
10.13.4 Footing.....	131
10.13.5 Layout And Preparation	132
10.13.6 Raising.....	132
10.13.7 Luffing	132
10.14 The 'A' Frame (or Sheerlegs)	132
10.14.1 Layout and Preparation	133
10.14.2 Guys	133
10.14.3 Raising.....	133
10.14.4 Luffing	133
10.15 Tripods (or Gyns).....	134
10.15.1 Layout and Preparation	134
10.15.2 Raising.....	135
10.15.3 Securing.....	135
10.15.4 Kickback	135

Chapter 11

Lifting Equipment

11.1 Levers.....	137
11.1.1 Fulcrum Blocks	137
11.1.2 Lifting	137
11.2 Hydraulic Rescue Equipment.....	137
11.3 Power Hydraulics	138
11.4 Hand Hydraulics.....	139
11.4.1 Contents Of Basic Hand Hydraulics Kit	139
11.4.2 Basic Kit Options (20 Tonne Lift And 5 Tonne Pull Rams, Ram Extension Tubes).....	139
11.4.3 Method of Operation	139
11.4.4 The Basic Kit Components	140
11.4.5 Special Features of the Equipment.....	141
11.4.6 Safety Points.....	142
11.4.7 Maintenance	142
11.4.8 Air in the System	142
11.4.9 Blank Caps	142
11.4.10 Accessories	142
11.5 Mechanical Jacks.....	143
11.5.1 Different Types Of Jacks.....	143
11.6 Airbags (High Pressure).....	144
11.6.1 Safety Warning	144
11.6.2 Airbag Advantages.....	144
11.7 Cribbing and Wedges.....	144
11.7.1 Considerations When Using Cribbing And Wedges.....	146

Chapter 12

Cutting Equipment

12.1 Introduction.....	147
12.1.1 Precautions in Operations	147
12.2 Power Saws	147
12.2.1 Rotary Saws—Metal and Masonry Cutting.....	147
12.2.2 Circular Saws—Wood Cutting	148
12.2.3 Angle Grinders.....	148
12.2.4 Reciprocating Saws (Jig Saws)	148
12.3 Battery-Powered Cutting Tools.....	149
12.4 Air-Powered Cutting Tools.....	149
12.5 Chainsaws.....	149
12.6 Hand Tools for Cutting.....	149
12.6.1 Bolt Cutters	149
12.6.2 Hacksaw	149
12.6.3 Axe.....	149
12.6.4 Handsaws	150
12.7 Cutting with Oxy-acetylene.....	150

Chapter 13

Power Equipment And Lighting

13.1 Generators	151
13.1.1 ELCBS and RCDS.....	151
13.1.2 Power Output Of The Generator.....	151
13.1.3 Precautions In Operations	152
13.1.4 Electrical Safety Precautions.....	153
13.1.5 Generator Operational Checks	153
13.1.6 Generator Maintenance	153
13.1.7 Storage	154
13.2 Lighting.....	154
13.2.1 Positioning Lighting.....	154

Chapter 14

Damage To Buildings, Debris Clearance & Tunnelling

14.1 Building Construction	155
14.2 Structural Standards In Australia.....	155
14.3 Types Of Construction.....	155
14.3.1 Timber.....	156
14.3.2 Light Frame (Ordinary Construction Weatherboard/Brick Veneer)	156
14.3.3 Reinforced Masonry.....	157
14.3.4 Un-Reinforced Masonry.....	157
14.3.5 Concrete Tilt-up	158
14.3.6 Reinforced Concrete and Steel Construction	159
14.4 Stresses and Loads on Structures	159
14.4.1 Tension	160
14.4.2 Bending.....	160
14.4.3 Shear	160
14.4.4 Compression.....	161
14.5 Structural Instability And Secondary Collapse.....	161

14.6	Collapse Patterns And Potential Voids.....	162
14.6.1	Curtain Fall Wall Collapse.....	162
14.6.2	Inwards/outward Collapse	162
14.6.3	Lean-over Collapse.....	163
14.6.4	Lean-to Floor Collapse	163
14.6.5	90 Degree Angle Wall Collapse	163
14.6.6	Pancake Floor Collapse.....	164
14.6.7	Inverted, 'A' or Tent Collapse	164
14.6.8	'V' Collapse	164
14.6.9	Cantilever Collapse.....	164
14.6.10	Progressive Collapse.....	165
14.7	Precautions in Operations.....	165
14.8	Crush Injuries	165
14.9	Debris Clearance.....	165
14.9.1	When Debris Clearance is Necessary	166
14.9.2	Methods of Debris Clearance	166
14.9.3	Precautions in Operations	166
14.10	Debris Tunnelling.....	167
14.10.1	Tunnel Sizes and Precautions	167
14.10.2	Timbering and Lining Tunnels.....	168
14.11	Lifelines	170
14.11.1	Lifeline Signals.....	170
14.12	Trenching	170
14.13	Breaching Walls	171

Chapter 15

Temporary Shoring And Elementary Demolition

15.1	Temporary Shoring.....	173
15.1.1	Materials	173
15.2	Folding Wedges	174
15.3	Types of Shore	174
15.4	Raking Shore.....	174
15.4.1	Principal Parts.....	174
15.4.2	Method of Erection.....	175
15.4.3	Variations to Raker Shore	177
15.5	Flying Shore.....	179
15.5.1	Principal Parts.....	179
15.5.2	Method of Erection.....	179
15.5.3	General	180
15.6	Dead Shore.....	180
15.6.1	Principal Parts.....	180
15.6.2	Method of Erection.....	181
15.6.3	General	181
15.7	Strutting Of Openings.....	182
15.8	Elementary Demolition	183
15.8.1	Available Methods.....	183
	LIST OF SHORTENED FORMS	185
	GRAPHIC ACKNOWLEDGEMENTS	186

Archived

Introduction

This manual is designed to provide emergency service personnel with the foundation skills and underpinning knowledge to perform safe and effective rescues in most situations.

It does not provide detail on equipment, techniques and procedures for specialist or technical rescue. These skills are provided for in other rescue publications, and in the following manuals of the AEM Series:

- Vertical Rescue
- Road Accident Rescue
- Flood Rescue Boat Operation
- Storm Damage Operations

Some of the techniques described in this manual are of an improvised nature and involve the use of items of equipment such as ladders in other than their normal modes of operation. These improvised techniques are included, as it is likely that they will have a wide application in rescue operations during a disaster.

Some general rescue/disaster operations are considered to be high-risk activities as they involve rescue operators in potentially life-threatening situations. This is true for both training and operational situations and it is important to recognise the risks involved, and to learn to identify, risk assess and control them.

Examples of typical risks for general/disaster rescue operators include slipping, falling or tripping over debris and equipment, being overcome by fumes from fuel, other chemicals or environments lacking in suitable breathable air, and other less foreseeable events.

There are also risks to operators who undertake unpleasant tasks, which may prove to be stressful, such as accessing the site of a fatality or body recovery.

It is of paramount importance that all who choose to undertake training and operations involving general rescue/disaster tasks do so having regard to the foregoing and are suited to working in this type of potentially hazardous environment.

People involved in all aspects of general/disaster rescue must also recognise the responsibilities they have to themselves, their team and others involved, including casualties and personnel from other agencies. Trainers, in particular, must constantly be aware of these and other less defined risks, and take the necessary steps to minimise and control them.

In this context, risk management will be part of every trainer's approach and will involve, for each session, the time to address the issues of:

- hazard identification
- conduct of a risk assessment
- application of controls, and
- monitoring controls throughout the training or operational activities.

Throughout this AEM, attention is drawn to the some of the hazards, risks and control measures that can be incorporated to ensure safe conduct of training and operations.

Archived

CHAPTER 1

RESCUE ORGANISATION, PLANNING AND EQUIPMENT

1.1 The Aim of Rescue

The aim of rescue is to save life and minimise further injury to people and damage to property.

1.2 Functions

Common rescue functions are to:

- a. access, and support and remove, trapped people in the course of rescue operations
- b. assist with the recovery of the dead, and
- c. provide support on request to other services, authorities or specialist teams.

NOTE

IN ORDER TO ACHIEVE THE AIM, ALL RESCUERS MUST BE TRAINED IN BASIC LIFE SUSTAINING FIRST AID TO RECOGNISED STATE OR TERRITORY STANDARDS.

1.3 The Psychology of Rescue

Any situation that requires a rescue operation has, by definition, either dangerous or potentially dangerous elements. Unless an individual faces a dangerous situation, there is nothing from which to be rescued.

People tend to react differently to danger, but the most general responses are anxiety and fear, perhaps the most powerful of all emotions. Remember that it is not just the victim who faces the danger. The rescuer must enter the site of the dangerous situation and face the same danger in order to rescue the victim. Dangers are still often present when the main danger has passed. The biggest difference between the victim and the rescuer is that the rescuer is better able to cope with, or handle, the situation. The rescuer has the knowledge and the resources to minimise risk and to remedy the situation.

It is normal to be anxious and feel fear in the face of danger. These emotional reactions are common to both victim and rescuer. Many other emotional responses may become manifest during a rescue situation—pity, disgust, contempt, pride, concern and many more. These are often exaggerated beyond all reason by the urgency and pressures of the situation, thus lowering the efficiency of the overall operation.

The rescuer must be aware of the psychological needs of victims, not just their physical needs, and be prepared to meet those psychological needs.

1.4 Rescue Workers

An event that requires rescue operations usually creates three categories of rescue workers.

1.4.1 Group 1—Survivors

The immediate reaction of survivors in a major incident, once they have discovered they are not injured, is to help their neighbours and families. They may not know what to do, but feel they must do something.

These good intentions can aggravate the conditions of those being 'helped' to the point where the loss of life may be greater than it should be. Individuals can also 'get in the way' and interrupt the function of trained rescue teams. However, uninjured and slightly injured survivors can be the only hope of survival for many victims, for example if toxic gases, dangerous chemicals or fire, or danger of fire, exist at the site of the emergency. The first group to commence rescue work at a site consists of survivors still physically capable of doing so. The potential for good is enormous but the danger inherent in rescue work by untrained personnel is also enormous.

1.4.2 Group 2—Untrained Personnel

The second 'wave' of rescue workers comes from people who either witness the event or are in the vicinity of the event. Curiosity and, for many, a desire to assist the victims draw them to the site. Although not quite as emotionally involved as the survivors, the danger inherent in using untrained personnel is a factor to consider. On the positive side, they often bring necessary resources with them and can be very effective if they can be brought under control and properly supervised. A large number of people are curious and just want to watch without helping rescuers. They can impede operations and need to be managed.

1.4.3 Group 3—Trained Personnel

The last group to arrive at the scene are the trained rescuers—police, fire, State Emergency Service etc. To mobilise various emergency services and arrive at the scene takes some time. The well-trained team knows what to do and how to use the available resources, materials and untrained personnel to efficiently carry out the necessary tasks in a manner that will not further endanger anyone.

1.5 Personal Traits of the Rescuer

Rescue work is not an easy task, nor necessarily a glamorous one. Not all people are suited to such work. Physical fitness, personality and emotional stability are factors involved in determining one's suitability.

Ideally, the rescuer will have the following qualities:

- a. **Interest**—A genuine interest in rescue work, not just peer pressure, trying to impress people etc.
- b. **Training**—The will to continually undergo training to maintain a professional standard.
- c. **Dependability**—The lives of victims and team members rely upon dependability.
- d. **Initiative**—The nature of rescue operations means that it is often impossible to closely supervise each team member. Each must be able to see what needs doing, set priorities, and do the tasks at hand.
- e. **Versatility**—Each situation is unique. An individual must be able to apply a wide range of skills and knowledge to new situations.
- f. **Cooperation**—Rescue work is usually a team effort and cooperation with others is vital.
- g. **Physical fitness**—Rescue work of any kind is physically demanding and often continues for long periods. Any physical limitations must be recognised and taken into consideration.
- h. **Leadership qualities**—Leadership qualities are required by all rescuers at various times and to varying degrees. Capable leadership by trained rescuers means that many more untrained personnel may be used.

- i. **Control over fears (phobias)**—Rescuers must know what they can and cannot do. Part of this knowledge consists of being aware of any phobias. It is also vital that the leader of a rescue team knows of any phobias in team members. Some phobias can seriously affect a rescuer. Phobias, which may be identified in training, include:
 - i) fear of the sight of blood
 - ii) fear of heights
 - iii) fear of confined spaces, and
 - iv) fear of water or drowning.
- j. **Good dress and bearing**—Appearance must instil confidence in others.

1.6 Personal Behaviour

The conduct of individuals tells a lot about their psychological make-up or personality. Given the nature of rescue work, it is particularly important that personal conduct does not aggravate matters. Personal behaviour must assist in creating a feeling that the situation is in competent hands and everything possible is being done to rescue and care for the victims.

Important general areas of conduct or behaviour include:

- a. **Attitude**—Maintain a serious, professional attitude to gain confidence and support. Arrogance and superiority create instant antagonism. Loud talking, joking and horseplay reduce credibility and create a feeling of resentment and disgust. They add to the confusion, hinder the work and add to the state of anxiety of the victims. Rescuers cannot consider themselves professional if they add to the confusion by loud shouting or frantic gestures.
- b. **Emotions**—Emotions are hard to control in the best of circumstances. In a disaster, the control of emotions is a very difficult task. Every effort is to be made to prevent emotions from influencing good judgment and competence. The rescuer must remain calm and be sympathetic without becoming emotionally involved, regardless of the excitement and the severity of the incident.
- c. **Courtesy**—Courtesy, tact and good judgment are vital. To quickly and effectively complete the rescue task, give courtesy to all concerned.

1.7 Team Composition

Team composition is determined by the various organisations within each State and Territory on the basis of safe accomplishment of set tasks. Appoint a team leader, regardless of the team composition.

1.8 The Rescue Plan

The success of rescue operations depends principally on the team leader conducting a quick and thorough reconnaissance of the situation and then, through the appreciation process, developing a workable plan.

1.9 The Reconnaissance

Every member of a rescue team must be trained in rescue reconnaissance: in many instances the team leader will be responsible for a number of tasks, and personnel deployed must be able to conduct reconnaissance and to report observations back to the leader. Exploit all sources to obtain information regarding casualties, damage and likely hazards.

The team leader's reconnaissance should aim for an accurate assessment of:

- a. the number and location of casualties
- b. dangerous situations such as gas, electricity, overhanging walls, unsafe structural components, or anything else which may endanger rescue personnel or survivors
- c. access to the casualties or task
- d. the extent and type of the damage
- e. appropriate services and support agencies
- f. available resources, both personnel and equipment, and
- g. the time the task will take with available resources.

1.10 The Appreciation Process

The appreciation process is a simple method of problem-solving which is effective in rescue situations. It involves the logical assessment of the situation and the reconnaissance, and results in the formation of a workable plan. Experienced rescue operators may use intuition and experience to enhance this decision-making tool.

The appreciation process has six steps:

- a. **Define the problem**—Clearly define the problem to be solved or the task to be accomplished. The problem may be too large or complex to tackle easily, and may be divided into a number of manageable elements, each with a set aim.
- b. **State the aim**—The aim is a clear statement of what the team has to achieve in order to solve the problem. The aim must be clear, concise, achievable and expressed in positive terms. The aim will form the mission statement in an operational briefing, and should be as simple as, for example, 'to rescue the casualty from the bottom of the lift shaft'.
- c. **Consider the factors**—Factors are points relevant to the problem that has to be solved. Factors to consider in an operational situation may include:
 - i) number and location of casualties
 - ii) time and space
 - iii) topography
 - iv) weather
 - v) available resources, both personnel and equipment
 - vi) support requirements and availability
 - vii) communications
 - viii) logistics, and
 - ix) priority of tasks.

Each factor will lead to one or more logical deductions. The leader should be in a position to say, 'if this is the case—then ...'.

Factors in an appreciation may be set out as in the following example:

Factor	The casualty's legs are trapped under a heavy steel beam.
Deduction	The rescue team must use cutting and lifting equipment to free the casualty.

Thoroughly examine each factor and take care not to introduce irrelevant facts into the examination.

- d. **Determine courses open**—In the ‘courses open’ segment, consider all possible courses that will attain the aim and that are practical. Consider only facts dealt with in ‘factors’; do not introduce new material at this stage.
- e. **Decide on the best course**—At this stage choose one of the possible solutions developed by the appreciation process. If more than one workable solution is produced and the best course is not obvious, apply the following criteria:
- i) Risk: Which solution carries the greater risk factor in its execution, or the consequence of failure?
 - ii) Simplicity: Which is the simplest course?
 - iii) Time: If urgency is a factor, which course can be completed in the shortest time?
 - iv) Economy: In terms of resources, which solution imposes the least demand?
- f. **Plan**—The plan will result from the choice of the best course open. That is, it will be the solution with the most advantages and the least disadvantages. The plan must be simple, and it must relate directly to the aim. When completed, check the plan against the following test questions:
- i) Is the reasoning sound?
 - ii) Is it set out in logical order?
 - iii) Is everything in it relevant to the problem?
 - iv) Has anything relevant been left out?
 - v) Is it free of uncertainties and ambiguities?
 - vi) Is it accurate (positions, timings and so on)?
 - vii) Has the aim been kept in mind throughout?
 - viii) Can the plan achieve the aim?

1.11 Operational Orders

Team leaders will be required to deliver operational orders to their team members, particularly orders of a search or rescue nature. The SMEAC briefing is a proven method of relaying instructions to a team. Team leaders should use this format as a checklist to make sure that they cover all points in communicating to their teams.

1.11.1 Orders Format

Orders are given in a format known as **SMEAC**, which is an acronym meaning **S**ituation, **M**ission, **E**xecution, **A**dministration and logistics, and **C**ommand and communications.

Some organisations have added additional elements to the SMEAC format as memory joggers.

1.12 Continuing Action

Having made decisions and deployed personnel, team leaders must continue reconnaissance with a view to allocating priorities for the further deployment of resources.

Rescuers deployed on a particular building, damaged by blast or natural causes, should make careful observation of how that building has collapsed. The art of rescue lies in being able to identify and exploit to the maximum all debris formations, such as voids etc, which can be used to facilitate access to casualties once their whereabouts have been fixed by firm information or inference.

Attempt to locate and identify the parts of the building and especially those parts in which casualties are reported to be. This will provide some idea of where casualties might be found in relation to the various parts of the damaged structure.

At times such as this, a leader will need to call upon all accumulated experience and training and combine them with effective decision-making.

1.13 Urban Search and Rescue (USAR) Training

Within Australia and internationally, a USAR system has been established to manage major structural collapse incidents. A USAR incident requires both generalist and specialist equipment and resources to enable effective and safe search and rescue.

The three categories of USAR training are:

- a. **Category 1**—Operator training is aimed at personnel who would be the first rescuers at structure collapse incidents and focuses on the rescue and/or removal of surface victims.
- b. **Category 2**—Operator training focuses on technical and specialist aspects of rescue, including accessing and exploring voids below the surface where victims may be trapped.
- c. **Category 3**—Operator training is directed at personnel in the command, control, management and integration of a USAR task force within local, State and/or Territory emergency management arrangements.

1.14 Rescue by Phases

A six-phase process provides a systematic means of conducting USAR operations at a structure collapse scene. These six phases are internationally recognised and have been adopted by agencies worldwide.

The **REPEAT** acronym assists response personnel in learning and remembering the six phases of USAR operations. The six phases are:

Phase 1—**R**econnaissance and survey.

Phase 2—**E**limination of utilities (risk assessment and controls).

Phase 3—**P**rimarily surface search and rescue.

Phase 4—**E**xploration of all voids.

Phase 5—**A**ccess by selected debris removal.

Phase 6—**T**erminate by general debris removal.

1.14.1 Phase 1—Reconnaissance and Survey

Upon arrival at an incident scene, it is critical to conduct a thorough reconnaissance and survey. During reconnaissance, question victims, witnesses, premises owners/occupiers and others who may be able to provide information such as occupancy of the building, location of victims, the reason for the collapse and potential hazards etc. Survey involves a visual inspection of the scene and may identify such things as the type and size of the structure involved, collapse patterns, hazards and location of victims.

1.14.2 Phase 2—Elimination of Utilities (Risk Assessment and Controls)

Phase 2 is one of the most important phases. It can often be overlooked because of the scene of carnage presented to the initial response personnel. It involves the assessment of risks and the application of control measures available to rescuers, such as barricading a rescue scene or shutting off power/water services. It is essential that the control of all risks be completed as soon as possible.

1.14.3 Phase 3—Primary Surface Search and Rescue

Systematically search surface areas around the collapsed or damaged structures. Attend to and extricate any injured or lightly trapped surface victims. During the primary surface search, rescuers may become aware of victims located within potential voids or within damaged structures. If this occurs, mark and report their locations to enable specialist USAR personnel with appropriate equipment and training to safely effect rescues.

1.14.4 Phase 4—Exploration of all Voids

In this phase, specially trained and equipped USAR personnel explore those places that have been marked, and all other places where trapped victims might have survived the collapse even when there is no evidence of the presence of such victims. If possible, use technical devices and/or canine search teams to verify the location of trapped victims.

1.14.5 Phase 5—Access by Selected Debris Removal

Phase 5 involves the selected removal of debris to access trapped victims. This requires USAR Category 2 personnel and equipment. In general, the victim's chance of survival decreases with each succeeding phase. Many people buried under debris in this phase will be deceased but explore their positions nevertheless and locate all victims before work starts on Phase 6.

1.14.6 Phase 6—Terminate by General Debris Removal

Phase 6 involves the use of heavy plant and machinery to remove all of the structure debris in an attempt to recover and account for all victims. This phase also involves the use of forensic processes to identify victims. It is important to note that, unless special orders to the contrary are given, a rescue operation must be carried on diligently without interruption until Phase 6 is completed. Every person known or likely to have been in the structure must be accounted for. It is impossible to tell from an external inspection of a pile of debris whether victims buried in the debris will be alive or not. Even the most tightly packed debris may be quite loose underneath and, in fact, experience has shown that this is often the case. In the absence of specific instructions to the contrary, there should be no relaxation of effort until this phase is complete, no matter how long the work may take.

1.15 INSARAG Incident Marking Systems

USAR marking systems were developed by the International Search and Rescue Advisory Group (INSARAG) to help rescuers mark, record and communicate information at a structure collapse incident. INSARAG was formed in 1991 as a cooperative effort by the United Nations and many of the participating countries in international search and rescue. The mission of INSARAG is to develop effective international relationships in order to save lives and render humanitarian services following natural disasters or disasters that are caused by humans. The activities of INSARAG include the improvement of emergency preparedness and cooperation between international search and rescue teams, and the sharing of information about operational procedures and lessons learned.

INSARAG has developed three USAR marking systems that have been adopted worldwide. The marking systems are for site identification, structure assessment and victim location.

1.15.1 Site Identification Marking System

Upon arrival at a structure collapse scene, act quickly to identify each structure involved and secure the incident scene.

This involves

- assigning geographical areas and numbers of each structure
- numbering the sides of each structure
- identifying and marking individual sections within each structure, and
- designating hot, warm and cold zones for incident operations.

Once this is achieved, use the site identification marking system to mark, record and communicate this information to all personnel.

The site identification marking system is particularly useful to the incident controller. It is an operational briefing tool as well as a tool to ensure that all structures involved in the collapse are systematically assessed, hazards are controlled, and surface search and rescue operations are conducted safely and effectively.

a. Marking structures in a multiple structure collapse area

It is important to clearly identify each separate structure within a geographic area. The primary method of identification is the existing street name and building number.

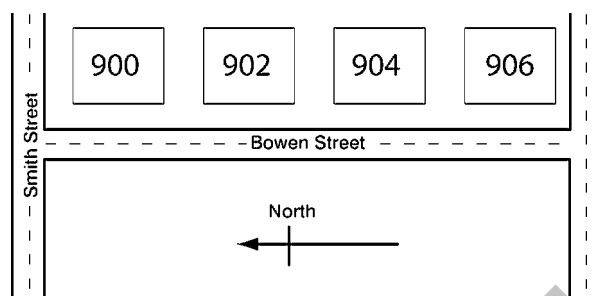

Figure 1:1

Identify multiple collapsed structures by street name and number

If previously existing street numbers have been obliterated, attempt to re-establish the numbering system based upon one or more structures that still display an existing number. Clearly mark the fronts of structures with the assigned number using 'international orange' spray paint. Also indicate the boundary frontage of individual structures using the spray paint or barrier tape.

b. Marking a single collapsed structure

All sides of each individual structure involved in a collapse should be numbered, starting with side one on the street address side of the structure and working clockwise around each structure.

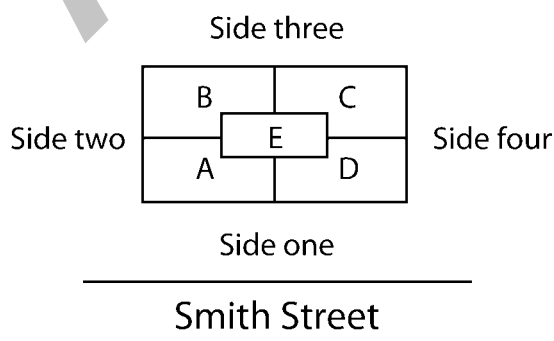

Figure 1:2

Number the sides of a collapsed structure

Each structure's interior should be divided into quadrants. Identify the quadrants alphabetically and in a clockwise manner starting from the area where side one and side two perimeters meet. The central core where all four quadrants meet is designated as quadrant E. Quadrants do not have to be symmetrical and can be altered to suit the needs of the incident.

c. Marking structures without street addresses

Collapsed structures with no street address, such as bridges and flyovers, can be divided into manageable sections along their lengths. The size of sectors will be based on the incident and geography of the area.

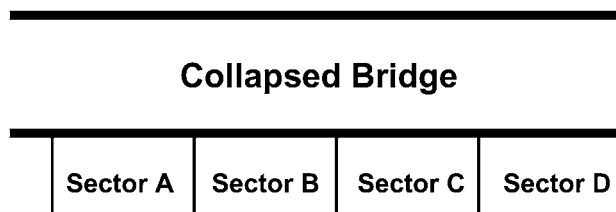

Figure 1:3

Marking collapsed structures without street addresses

1.15.2 Structural Assessment and Search Marking System

The structural assessment and search marking system is used to indicate hazard information (for example structure requires shoring/rats found); number of people found alive and removed; number of people found dead and removed; number of people unaccounted for; and the location of other victims. The team members, or an advance reconnaissance team, place signs adjacent to the safe entry point of the structure prior to the deployment of rescue operations.

Use this marking system also, where appropriate, inside the structure adjacent to rooms, hallways and stairwells. Team members must be aware of secondary entrances, which will be signed alike. Any entries not signed in the appropriate manner should be considered unsafe and dangerous, and should not be used. Update information as subsequent assessments are made. Write new information either below the previous entry or draw a completely new marking box.

a. Structural assessment and search marking box

The structural assessment and search marking system consists of a square box (1 m x 1 m) drawn using 'international orange' paint (tape or crayon may be used to minimise damage).

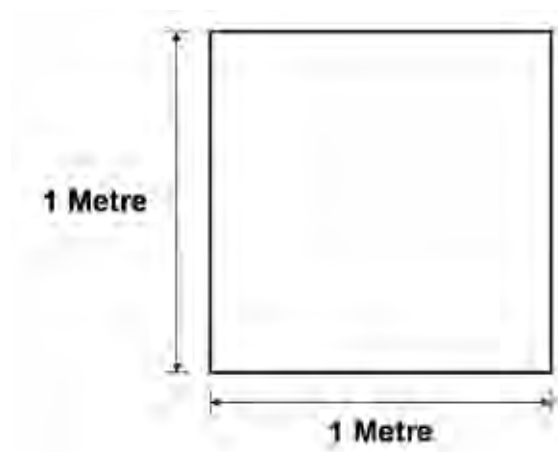

Figure 1:4

Marking box symbol

Display the relevant information on the outside and inside of the box as follows:

- i) **Top** of square: hazard information (for example, structure requires shoring/snakes found).
- ii) **Left** side of square: number of people found alive and removed.
- iii) **Right** side of square: number of people found dead and removed.
- iv) **Bottom** of square: number of people unaccounted for and the location of other victims.
- v) **Inside** the square: G (Go) indicates the structure is safe to enter; NG (No Go) indicates the structure is not safe for entry; the name of the USAR team; the time and date the USAR team entered the structure; and the time and date the USAR team exited the structure.

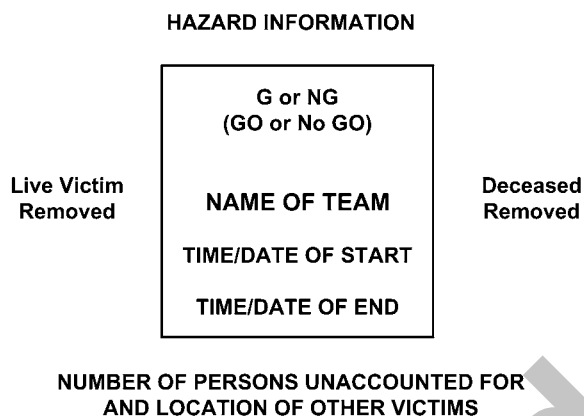

Figure 1:5
Structural assessment and search marking information

b. 'No Go' areas for USAR Category 1 operators

Where collapse areas are assessed as requiring shoring, breaking or breaching to conduct search and rescue operations, use the structure assessment marking system to mark these areas as 'No Go' for USAR Category 1 operations. USAR Category 2 operators will re-assess these areas upon arrival and decide upon the appropriate course of action as applicable to Category 2 operators.

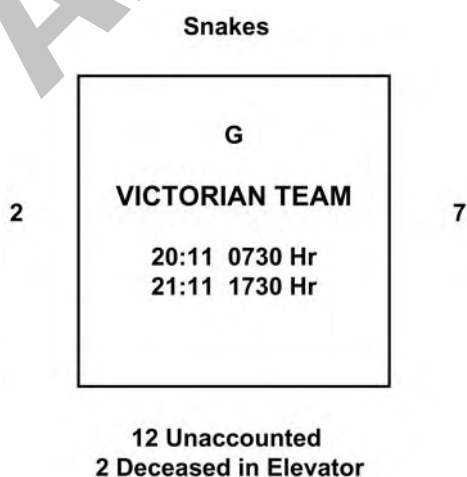

Figure 1:6
A partially completed marking box

Every time rescuers enter and leave an area or sector, the structural assessment and search marking system must be updated with the following information: team name; date and time of entry/exit; hazards; and information of possible victims, including numbers of rescued victims, number of live or deceased victims, and their locations.



Figure 1:7

Completed structure marking box

Note: The finished marking system is circled. This does not mean that all victims have been removed from the structure. It simply indicates that the marking box has been completed and that the assessment of the structure has been completed.

1.15.3 Victim Marking System

It is important to mark the victims' locations. USAR teams may at any stage be evacuated or relieved from the area, and a different team may be assigned to remove the victims. The victim location marking system is used to clearly mark the potential and confirmed locations of victims in the structure collapse area and to indicate whether they are alive or dead. Markings are made with a high visibility paint, chalk or crayon.

Place markings as near as practical to a victim and identify the direction and distance to the victim's location. USAR teams place victim location markings whenever a known or potential victim is located in a structure and the victim has not been immediately removed.

If victims can communicate, ask them if they know of any other victims and where they are or were located. Apply markings to represent the following information:

- a. potential victim
- b. victim location
- c. confirmed victim(s)
- d. extricated live victim(s)
- e. extrication of live victims only
- f. all victims extricated.

a. Potential victim

Indicate a potential victim by a 'V' drawn in the area to identify the location.



Figure 1:8

Potential victim location marking

b. Victim location

Indicate the victim's location by an arrow drawn in the direction of the confirmed victim location.



Figure 1:9

Confirmed victim location marking

c. Confirmed victim(s)

On confirmation of a victim(s), write the following letters under the 'V':

- i) 'L' for **live** victim(s) and the number of victims, and
- ii) 'D' for **deceased** and the number of victims.



L# (Number of live victims)

D# (number of deceased victims)

Figure 1:10

Confirmed victim(s) 'live and dead'

d. Extricated live victim(s)

When extrication of the live victim(s) has occurred, draw a horizontal line through the 'L' and the number. The indicator now has only the letter 'D' (deceased) and the number indicating the number of deceased still remaining.

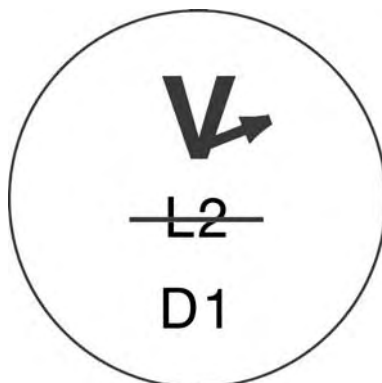

Figure 1:11

Extricated 2 x live victims

e. Extrication of live victims only

When all live victims have been extricated and the task allocated to the USAR team is completed, the USAR team draws a circle around the entire marking when leaving that location.

**Figure 1:12**

Extrication of 2 x live victims, team moved on

f. All victims extricated

Once removal of all remaining deceased victims from the site has taken place, complete the marking system by drawing a horizontal line through the 'D' (deceased) and the number.

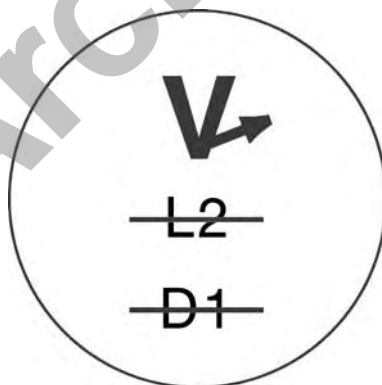
**Figure 1:13**

Extricated 2 x live, 1 x deceased victim(s)

1.16 Location Techniques

Once surface and/or lightly trapped victims are removed, surface search and rescue operations should focus on searching for, locating and marking positions where contact is established with victims and where voids that potentially contain victims are discovered.

The techniques used to achieve this include line and hail search, and canine search.

1.16.1 Line and Hail Search Technique

The line and hail search procedure offers a structured and systematic approach to ensure that all areas of the site are searched.

Its main objective is to locate live victims who may be trapped below the surface of the rubble.



Figure 1:14
USAR operators preparing for a line and hail search

1.16.2 Conducting a Line and Hail Search

A 'Go' area of the collapse site is selected in accordance with the search priorities that have been established.

Note: To ensure that no area is left unsearched, mark the search line position prior to any adjustment. This provides a point to which it should return.

The line and hail search team members excluding the team leader stand in a straight line approximately 1.5 m to 2 m apart at the edge of the structure collapse site.

The team leader coordinates the search from behind the team or from a vantage point, ensuring he/she can see all the team members. This ensures the team leader can listen and watch for signs of a response as indicated by the team members. The line of team members is numbered sequentially from the team leader's left-hand side, starting with number one.

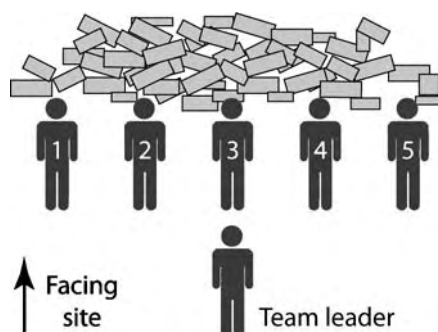

Figure 1:15
Line and hail starting positions

The team leader gives the order, '**Quiet on the site**', and instructs team member number one to commence the search call.

The first team member calls into the rubble, '**Rescue team working above, can you hear me?**' The entire rescue team listens for a response for 15 to 20 seconds. If nothing is heard the team member shouts, '**Nothing heard**'. The next member in line then repeats the call. After all team members have called and there is no audible contact, the team leader instructs the team to advance 1 m into the search area, where the process is repeated.



Figure 1:16
Line and hail team calling

1.16.3 Actions Upon Hearing a Victim

Any team member who hears a call or any other noise coming from the structure collapse site must raise an arm until acknowledged by the team leader. He or she must then point with an arm fully extended in the direction he or she believes the noise is coming from and remain in that position until otherwise directed by the team leader.

The team leader can then move individual team members to pinpoint the source of the noise (that is, vectoring).

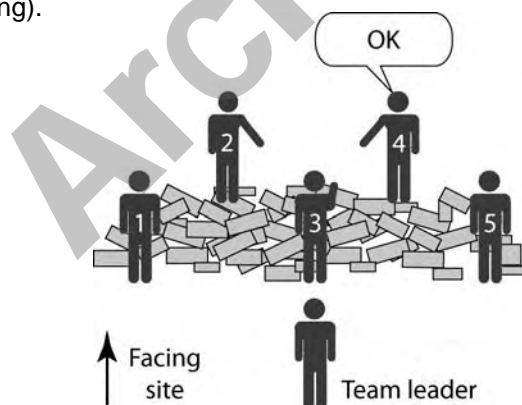

Figure 1:17
Identifying the position of a trapped victim

1.16.4 Action Upon Establishing Contact with a Victim

If contact is established, the rescuer must question the victim if the victim is able to speak. The questions should focus on receiving information, which will help the team leader to assess the situation.

Questions should focus on the nature of the victim's injury (if any), possible openings in the vicinity of the victim, the number of other victims trapped in the vicinity, and any other relevant information. During the assessment the team leader should try to establish if any breaking, breaching or shoring is required to rescue the trapped victims. If the trapped victims can be removed without breaking, breaching or shoring, extricate the victim. If this is not the case, USAR Category 2 operators will be required to free the trapped victim.

The USAR Category 1 team undertaking the line and hail search must mark the position of the trapped victim using the international USAR marking system and leave two team members with the trapped victim to maintain contact until the USAR Category 2 operators arrive. Once communication has been established with a trapped victim, it should be maintained as far as it is practically possible to do so. The communications will:

- maintain the victims' morale
- help them to withstand whatever pain and discomfort they may be suffering (and may even keep them alive)
- help USAR Category 2 operators to work in the right direction (sometimes a difficult task in the dark), and
- assist the USAR Category 2 response personnel with information about displacement or movement in the debris that is likely to cause further injury.

Note: Conversation with a trapped person must always be of a reassuring nature.

Archived

CHAPTER 2

SAFETY IN TRAINING AND OPERATIONS

2.1 Introduction

The task of rescue involves the training of individuals and teams in a variety of skills, some of which, unless properly carried out, may well prove dangerous to the individual rescuer, the team, casualties or bystanders. In all cases, the safety of rescuers is of prime importance.

It is necessary, therefore, particularly in the early stages of training and exercises, to pay a great deal of attention to safety measures, and to emphasise the need to strictly observe and enforce these measures.

WARNING

CARRY OUT ALL RESCUE TRAINING AND OPERATIONS WITH DUE REGARD TO STATE TERRITORY/AGENCY SAFE WORK PRACTICES, OCCUPATIONAL HEALTH AND SAFETY REQUIREMENTS, CODES OF PRACTICE AND STANDARD OPERATING PROCEDURES.

Many of the safety precautions to be observed are merely commonsense. Unfortunately, they are so basic and simple as to be often overlooked.

2.2 Basic Precautions

Appoint safety officers for any exercise or other activity in the rescue field. Team leaders and service officers are responsible for safety at other times. Obey the orders given by these officers without question or delay, as they are vital to safety.

Regularly and carefully check equipment, both before and after use. Ropes can wear and rot, batteries can corrode equipment, and machinery can break down. Faulty equipment can cost lives.

Immediately label any faulty or suspect equipment and remove for repair or replacement (for example, the rope which a rescuer did not check and which was damaged may kill someone the next time it is used).

Protect personnel at risk at heights or depths with properly established and monitored safety lines and systems.

Wherever possible, adhere to standard techniques and practices in the rescue field.

Never ignore or exceed safety limits and margins. In any rescue technique, safety limits and margins have been built in to protect the casualty and the rescuer.

WARNING

**BE AWARE THAT LEGISLATION VARIES THROUGHOUT THE COMMONWEALTH.
BE AWARE OF THE RELEVANT STATE/TERRITORY LEGISLATIVE OR POLICY
REQUIREMENTS FOR THE PROVISION OF RESCUE SERVICES.**

2.3 Protective Clothing and Safety

Each rescuer is issued with protective clothing, safety boots and helmets. Each piece has an obvious safety application and must be properly used.

Wear helmets, in particular, at all times of risk, whether great or small. Helmets are designed to protect the wearer from a single impact. Never mistreat them by dropping, throwing or sitting on them, and never leave them exposed on the back window-ledge of cars for prolonged periods.

Maintain and replace all safety equipment in accordance with the provisions of State/Territory/service policy and Australian Standards.

For training and operations, other safety items and items of protective clothing, such as listed below, may be issued. These are all for specific purposes. Treat and use them with utmost care.

Item	Points to remember
Foul weather gear	Not too hot or heavy for the type of work being attempted
Gloves	Debris gloves sufficient for the task; latex gloves if required
Dust mask or filter	Should be P2 as a minimum standard; used as required
Safety goggles	Correct rating for existing hazards
Ear protection	Correct rating for noise levels; make sure all can still hear commands and warnings
Safety harnesses	Correctly fitted and correct type
Knife	Ensure lanyard is not a snag hazard
Chalk/crayon/spray paint	To mark areas that have been searched
Whistle	To signal commands or to attract attention
Knee or elbow pads	Protection when moving over rubble
Sunscreen and hat	For working in the sun
Water	To prevent dehydration

2.4 Rescue/Safety Harnesses

Personnel working at heights or in similar dangerous environments require the protection and safety of a harness. A properly fitted climbing, rescue or safety harness is essential. Waistbelts or tie-ins are not acceptable. Use a rated screwgate karabiner or Maillon Rapide for harness attachment and secure the rope or strop to the harness by this device at the approved point.

Most industrial safety harnesses are not suitable for rescue. They have no dynamic fall arrest capability, and their attachment points are normally not suited to rescue techniques. They are, however, acceptable for low-risk static situations.

Further information on the selection and use of harnesses for general rescue is available in the Australian Emergency Manual Vertical Rescue.

2.5 Casualty Safety

The safety of casualties is of prime importance. Make every effort, including the use of protective equipment, to ensure that casualties come to no further harm once a rescue team arrives at the scene.

For the sake of realism in training, it is an advantage to use live casualties in exercises and drills. Teams should bear in mind the added safety required when dealing with heights, water and contaminated areas, where dummy casualties may be substituted. In most cases, it is only by handling live casualties in training and exercises that rescuers will appreciate the problems they will encounter in operations.

In many cases, live casualties on exercises will be team members or members of other services, but approach each situation as 'the real thing'. The use of team members as casualties can lead to a casual approach to the task, but this must be suppressed, as it can lead to a casual approach to real casualties. Horseplay or casual handling of exercise casualties is unsafe and must not be tolerated.

If at anytime during training or exercise, a simulated casualty or participant feels in danger or experiences real pain or injury, he or she is to say an agreed proword (for example, 'casreal', 'no duff', 'for real') so that the training rescue operators realise that there is a real casualty and respond appropriately.

2.6 Safe Working in a Confined Space

In rescue operations, many environments will fall within the definition of confined spaces, as laid down in Australian Standard/New Zealand Standard AS/NZS 2865:2001 and accepted as Occupational Health, Safety and Welfare Act codes of practice in many States and Territories.

Conduct hazards identification and dynamic risk assessment of the atmosphere of a confined space.

A confined space is an enclosed or partially enclosed space at atmospheric pressure during occupancy and is not intended or designed primarily as a place of work. It is liable at any time to:

- a. have an atmosphere which contains potentially harmful levels of contaminant
- b. have an oxygen deficiency or excess, or
- c. cause engulfment, and
- d. could have restricted means for entry and exit.

2.7 Vehicle Safety

While travelling to or from operations, rescuers are at some risk. Take all possible precautions to reduce the risk of accident. Ensure all drivers are aware of Australian road rules and the organisational standard operating procedures (SOPs) for vehicle operation.

Emergency vehicles must be driven by an authorised driver in accordance with the Road Traffic Act, particularly with regard to the use of warning lights and sirens. Maintain vehicles and trailers in first-class condition, and ensure that regular checks and inspections are routine.

Upon arrival at an accident scene, position the rescue vehicle with due regard to the site hazards such as traffic speed and direction, and road and weather conditions. Rescuers must ensure that road users are not exposed to unnecessary risks from rescue vehicle positioning or by setting out visual warning devices to protect the team and the vehicle.

The aim of a rescue team is to assist the public in time of need. Always bear this in mind when travelling to an emergency. Little can be done for the original casualties if the rescue team is involved in an accident en route.

2.8 Equipment Safety

Use all equipment in close compliance with manufacturers' operating instructions, and follow these basic safety rules for rescue tools and equipment:

- a. Wear safety goggles and gloves when using power tools such as disc cutters or saws, and take care to avoid jamming blades.
- b. When it is necessary to cut in close proximity to a trapped casualty, direct the cutting blades away from the casualty's body where possible, and protect the casualty's body with shielding.
- c. Many items of equipment have been specifically designed for particular tasks. Give careful safety consideration before any modification of equipment or method of use is attempted.
- d. Use only blades, fuel, oil, hydraulic fluid and parts that are recommended by the manufacturer.
- e. Never refuel petrol-driven motors while they are hot, and keep them apart from fuel supplies and casualties.
- f. In load-lifting operations, take care to continually pack under the load to prevent total collapse in the event of equipment slippage or failure.
- g. Adhere to all specific safety procedures for rescue equipment, and carry out regular and careful safety checks before and after use.

2.9 Public Utility Hazards

2.9.1 General

Any emergency, from a vehicle accident to a disaster, can rupture gas or water services, or bring down electrical power lines.

Treat all utility services with the utmost care and, where possible, either remove the casualty from the source of danger, or remove the danger from the proximity of the casualty.

In a disaster, rescuers must consider their own safety as more important than any single casualty. The loss of a single rescuer could well affect the capability of the team to conduct an effective rescue and save a large number of lives. Weigh this against the dangers involved in tackling a hazardous situation.

2.9.2 Gas [Domestic and Liquefied Petroleum Gas (LPG)]

Escaping gas creates the danger of explosion. Observe the following safety precautions:

- a. Do not enter a confined space without the appropriate training and equipment. If you smell gas, turn off the supply and allow time for the area to clear.
- b. Never look for a leak with a match. Use soapy water and, if you find a leak, turn off the supply immediately.
- c. Be extremely careful of leaking liquid propane or butane. Serious frostbite burns will occur on contact with the liquid.
- d. If a cylinder is leaking liquid while lying on its side, stand the cylinder upright before turning the cylinder off.

- e. If a line is broken and the supply cannot be turned off, cut the line and crimp it with a pair of pliers.
- f. A leak that cannot be turned off can often be stopped by binding the area with a wet cloth. This will freeze over and temporarily prevent any further leak. Use thick gloves when attempting this.
- g. If it is not possible to stop the cylinder leaking, remove it to a safe place outdoors and keep people and ignition sources at least 20 m away.
- h. If fire is present around a cylinder, keep the cylinder cool by hosing it with a water spray.
- i. If a cylinder valve cannot be closed and the gas is burning, keep the cylinder cool by hosing, but do not attempt to extinguish the flame, as the build-up of burned gases may explode if re-ignited.
- j. Never attempt to ignite a gas leak.
- k. Never smoke in a confined space where gas may be present or is suspected.
- l. Never use power tools or oxy-acetylene torches in a confined space where gas is suspected.

2.9.3 Water

Water from broken mains may enter areas in which casualties could be trapped. Steps should be taken to reduce the risks of immersion or drowning.

2.9.4 Sewers

Broken sewers may create problems of flooding and escaping gas. Sewer gases can be explosive, as well as toxic. Observe the following basic precautions:

- a. Take appropriate action prior to entering any confined space or area containing sewage.
- b. Never use an open flame.
- c. Endeavour to divert the flow away from the rescue area by building a dam or other obstruction, or by pumping.

2.9.5 Electricity

Live wires present a serious hazard to trapped casualties and rescue personnel. Observe the following safety precautions at all times:

- a. Assume all electric wires are 'live'. The fact that wires do not sputter or spark is no indication that they are dead.
- b. Avoid pools of water close to live wires—they may be just as dangerous as the wires. Avoid all other conductors such as metal doors and wire fences that may be in contact with high voltage wires.
- c. Switch off the supply to a damaged building at the main switch, normally located in the meter box. Remove and secure the fuses. Any supply that has been disconnected by emergency workers should be tagged in accordance with State and organisational standards and SOPs. No tag is to be removed until clearance is obtained from the site team leader.

- d. Step potential—Electricity passes through the ground. If you were standing on the ground near a fallen power line, you would receive an electrical shock dependant on the relative position of each foot compared to where the power line touches the ground. If you were standing with one foot in the inner circle and the other in the outer circle, as indicated in Figure 2:1, you would receive a shock of 120 volts AC (Alternating Current), being the difference between the two potential rings.

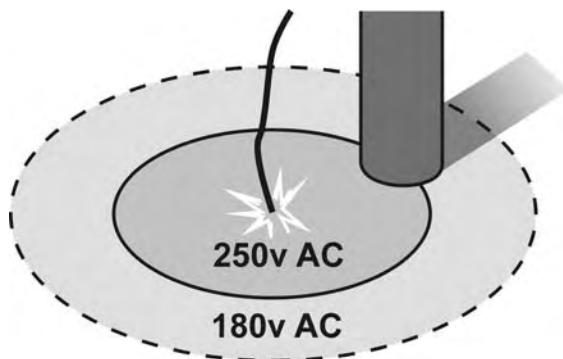

Figure 2:1
Step potential

- e. DO NOT attempt to cut any electrical wires.
- f. Keep vehicles and personnel well clear of areas where wires are down.
- g. Be particularly cautious at night when it is difficult to see wires.

WARNING
EVEN WHEN METER BOX SWITCHES ARE OFF AND FUSES ARE PULLED, THE BUILDING WILL STILL BE 'LIVE' FROM THE METER BOX TO THE STREET SUPPLY. SEEK EXPERT ASSISTANCE.

2.10 The Responsibility for Safety

Safety is the principle consideration in any rescue activity and it is the responsibility of each rescuer to ensure that safety procedures and occupational health and safety requirements are followed, instructions observed and operations carried out with a minimum of risk.

Each State and Territory has very clear guidelines, codes of practice, regulations and procedures that relate to safety and to operational aspects such as critical incident stress and risk management. Additionally, individual services have clear procedures for the management of these factors, and for laying out individual and organisational responsibilities. Take all these factors into account in the management of rescue activities.

This section has generally covered the key points of safety in training and operations as they affect the rescuer, the casualty or the bystander. Specific safety points will be covered with each rescue technique as they affect the conduct of that rescue system.

2.11 Correct Lifting Techniques

At all levels of rescue training and operations, rescuers will be required to lift, haul or push loads and must be trained to handle these tasks properly and safely, where mechanical lifting aids are not available/usable.

There is a serious risk of spinal or abdominal muscle injury due to incorrect lifting. The following points detail correct lifting techniques:

- As the leg and thigh muscles are stronger than those of the arms, back or abdomen, these are the muscles to use for safe lifting.
- During a lifting operation, crouch down with knees bent, back straight and feet properly placed to bear the load (see Figure 2:2).
- Grip the load correctly and start the lift by the thrust of the legs, and continue this thrust until the legs are straight. Keep the load close to the body and keep the back straight. In this way, the strain involved is placed on the leg muscles, and the possibility of back or abdominal injury is greatly reduced.
- Lower loads in the reverse manner to the lifting techniques.

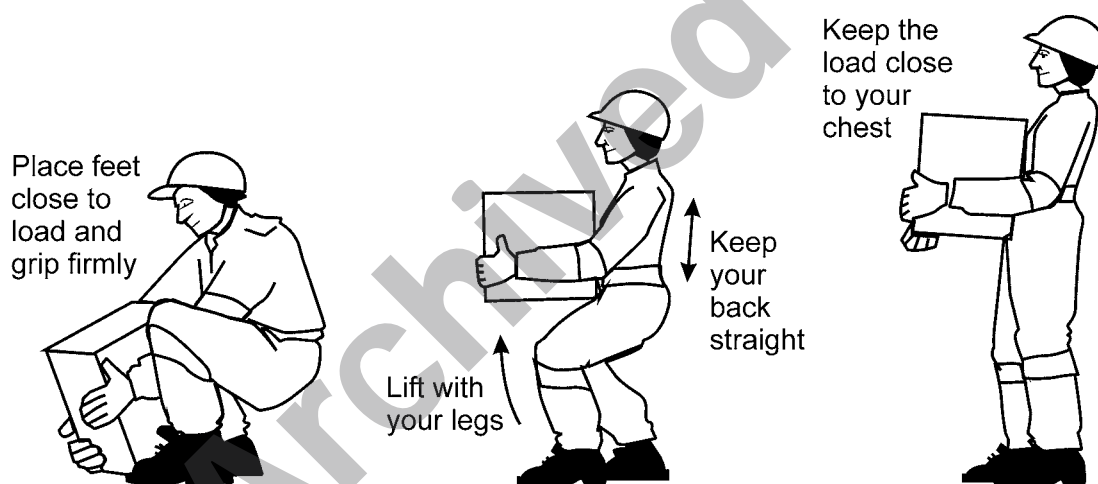

Figure 2:2
Correct lifting technique

2.11.1 Team Lifting

Team lifting uses the same individual techniques already described, but with team discipline and control. When the team is in position with respect to the load, the leader gives the preparatory order, 'Prepare to lift'.

Any rescuer not ready to lift quickly calls 'Stop', and the team leader must wait until all is in order before again giving the preparatory order. In the absence of any dissent, the team leader gives the executive order, 'Lift'.

On this command, all rescuers lift their portion of the load by the technique already described, slowly and in unison.

As with the individual technique, lowering a load is the reverse of this procedure. The team leader uses the commands 'Prepare to lower' and 'Lower'.

Archived

CHAPTER 3

FIRES AND ELEMENTARY FIREFIGHTING

3.1 Responsibility for Firefighting

In rescue situations involving fire, it is the fire service's responsibility to extinguish the fire. Rescuers do not normally commence operations until advised by the fire service that it is safe. Sometimes rescuers will be the first to arrive at an incident involving fire, or may be required to protect rescue equipment such as generators. Therefore, rescuers require a basic knowledge of fire, firefighting techniques and equipment.

3.2 What is Fire?

Fire is a **chemical reaction** that gives off large amounts of heat and light. This chemical reaction takes place between fuel, which is any substance that can burn, and an **oxidiser** (usually oxygen, which is a gas that makes up about 21 per cent of the air we breathe). The chemical reaction of fire is started and kept going by the presence of enough **heat**. Once started, a fire may produce enough of its own heat to keep burning until all the available fuel and/or oxidiser is used up.

Fire consists of a series of very fast chemical changes forming a **chemical chain reaction**.

The four factors of fuel, heat, an oxidiser and an uninhibited chemical chain reaction are sometimes depicted as the fire tetrahedron (a tetrahedron is a four-sided figure, see Figure 3:1). Effectively removing any one of the four factors will result in the fire being extinguished. Effectively keeping the four factors separated will result in the prevention of fires.

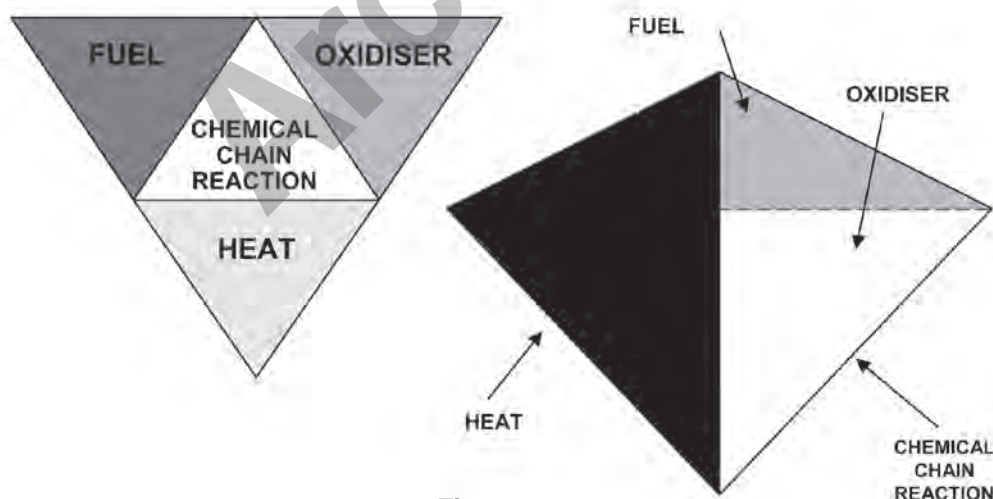

Figure 3:1
The fire tetrahedron

3.3 Classes of Fire and Methods of Extinguishment

A fire can be extinguished or 'put out' by:

- starving** the fire of fuel
- smothering** the fire, to cut off the supply of oxygen
- cooling** the fire, to remove the heat
- inhibiting** the chemical chain reaction.

Fires are classified according to the type of fuel that is burning, as shown below.







Class of fire	Fuel and extinguishment
<p>Class A</p> 	<p>Class A Common, solid fuels, such as wood, paper, fabric, plaster and rubber.</p> <p>Extinguish by cooling.</p>
<p>Class B</p> 	<p>Class B Flammable and combustible liquids such as petrol, alcohol, kerosene and oil.</p> <p>Extinguish by smothering or inhibiting.</p>
<p>Class C</p> 	<p>Class C Flammable gases, such as natural gas, LP gas, hydrogen and acetylene.</p> <p>Best extinguished by starving the fire of its fuel.</p>
<p>Class D</p> 	<p>Class D Combustible metals, such as magnesium or aluminium shavings.</p> <p>Special smothering methods are needed to extinguish them.</p>
<p>Electrical</p> 	<p>Electrical There is no 'official' Class E fire. Electricity is not a fuel; it does not burn like a fuel. However, it is a dangerous complication at a fire, because it is a source of heat and potential electric shock. Fires involving electricity are normally best extinguished by smothering or inhibiting, but only with a substance that is a non-conductor of electricity. Extinguishers that are safe to use on electrical fires may have an E in parentheses on their labels—(E).</p>
<p>Class F</p> 	<p>Class F Combustible fats and oils, such as those found in food deep fryers. These need special smothering methods to put them out.</p>

Table 3:1
Classes of fire and methods of extinguishment

3.3.1 Firefighting Agents

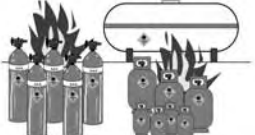
Different types of firefighting agents (substances that can extinguish fires) are described below:

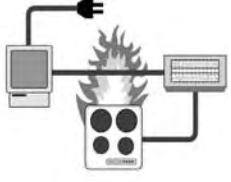
a. Water

Water is a very effective cooling agent for extinguishing Class A fires (that is, common solid combustible materials). However, water can be dangerous to use on other classes of fire. In particular, if you use water on a fire involving electrical equipment, you can receive a deadly electric shock. Water should not be used on a flammable liquid fire, as it may splash the flammable liquid about and spread the fire.

b. Foam

Foam is produced by mixing a foam-making concentrate with water, then aerating it to form robust bubbles. Foam is used as a smothering and cooling agent for extinguishing Class B fires (that is, flammable and combustible liquids). Most types of foam are also effective on Class A fires, and some are specially made for use on Class A fires (including bush fires). Because foam is water-based, it can be dangerous to use on a fire involving electrical equipment or materials (such as combustible metals) that can react with water.

Different types and makes of foam are made for different types of fires. The foam available on site will be the one that best matches the type of fire likely to occur on the site. Different foams may need to be used in different concentrations. Many foams use a 6 per cent concentration (that is, 6 parts of concentrate mixed with 94 parts of water), but some foams use 3 per cent or lower concentrations. Foams can also have different expansion ratios (that is, ratio of volume of foam solution to aerated foam). Most foam is produced at low expansions (about 10 to 1), but medium (about 100 to 1) and high expansion foams (about 1000 to 1) are also available. The latter are used to extinguish fires in cavities such as basements, the holds of ships and mines.

c. Extinguishing powder

Extinguishing powder is effective as a **smothering** and **chemical chain reaction-inhibiting** agent for extinguishing Class B fires (that is, those involving flammable and combustible liquid). Extinguishing powder is safe for use on fires involving electricity. A special type of extinguishing powder, called Multi-class, Tri-class or AB(E) powder, is also suitable for putting out Class A fires. High performance powders, such as Monnex and Purple K, are also available and are much more effective than the 'standard' powder on flammable liquid fires. Extinguishing powder is a particularly swift-acting firefighting agent. However, once the powder disperses, there is a risk of the fire re-igniting, especially if it involves flammable liquids. The powder residue might also damage sensitive equipment and requires careful clean up after the fire.

d. Carbon dioxide

Carbon dioxide (or CO₂) works as a **smothering** agent for extinguishing small Class B fires and fires involving electrical equipment. Carbon dioxide is not as effective as extinguishing powder, but has the advantage of being a gas, which means it leaves no mess or residue. Carbon dioxide makes a loud roar and is intensely cold when it is discharged. Once it disperses, there is a risk that the fire may re-ignite. Carbon dioxide may be mixed with other gases in some fixed fire protection systems. An example is Inergen, which is a mix of carbon dioxide, nitrogen and argon.

e. Vaporising liquids

Vaporising liquids are a group of **chemical chain reaction-inhibiting** and **smothering** agents for extinguishing Class B and Class A fires and those involving electrical equipment. They are stored as a liquid in an extinguisher, but vaporise into a gas once discharged. Once the gas has dispersed, there is a risk that the fire may re-ignite. When used on a fire, vaporising liquids may produce fumes that are hazardous, particularly in a confined area.

Note: The old vaporising liquid BCF (bromochlorodifluoromethane or Halon 1211) has now generally been withdrawn from use. Replacement agents, such as NAF P-III, are now used in extinguishers in some workplaces. Other vaporising liquid agents found in fixed fire protection systems now include FM-200 and NAF S-III.

f. Wet chemical

Wet chemical is a special smothering agent used to extinguish Class F (hot fat) fires such as those occurring in food deep fryers. Wet chemical is an alkaline liquid that reacts to form a smothering soap layer on the surface of burning fats. When an alkaline reacts with fat, it produces soap.

g. Special agents

Special firefighting agents are used for special types of fires, such as those involving combustible metals (Class D). These may include powdered graphite, Ternery Eutectic Chloride (TEC), Tri-Methoxy Boroxine (TMB) and other proprietary products. Check manufacturer instructions for their use if you have these agents on site.

3.4 Fire Extinguishers

Fire extinguishers are cylinders containing a firefighting agent, which can be discharged on to a fire when needed.

No one type of extinguisher can extinguish all types of fire. Each firefighting agent has its own characteristics and limitations and using the wrong type of extinguisher can be ineffective and very dangerous for the operator.

Extinguishers are marked according to the firefighting agent they contain. In Australia, in the past, extinguishers were colour-coded according to the agent they contained. Since 1997, the international colour code (red for all extinguishers, with a colour-coded band) has been adopted. Table 3:2 shows the types of extinguishers available, their band colour code and the types of fire on which they can be used.

Note: The same colours have been used for the bands as were used for the previous extinguisher colour codes. You might still occasionally come across extinguishers with the old colour code system.

3.4.1 Types of Fire Extinguishers

Type of extinguisher	Colour of band	Class of fire	Comments
Water	Red	A	Not safe on other classes of fire.
Foam	Blue	B, A	Not safe on other classes of fire.
Powder	White	B, (E)	AB(E) type powder is also suitable on class A fires.
Carbon dioxide	Black	(E), B	Has a loud and cold discharge.
Vaporising liquid	Yellow	(E), A, B	Older types (BCF) have been withdrawn from general use.
Wet chemical	Oatmeal	F	Can also be used on class A fires.

Table 3:2
Types of fire extinguishers

The different types of fire extinguishers are described below:

a. Water

Water extinguishers should be used only for Class A fires. The range of the discharge is about 6 m and it should be directed at the base of the burning material. Discharge duration is usually about a minute. Hose reels installed in buildings can be used for similar firefighting purposes as water extinguishers. Hose reels are often designed in such a way that the water valve locks the nozzle in place and it cannot be withdrawn until the valve is opened. Water can be electrically conductive and water extinguishers and hose reels should never be used on fires involving live electrical equipment. Also, water from an extinguisher or hose reel should not be applied to burning flammable liquids, as this will cause the fire to spread and can dangerously increase fire intensity.

b. Foam

Foam is primarily used on Class B fires, but can also be used on Class A fires. The range of discharge is about 3–4 m and discharge duration is about a minute. Direct the foam so that there is minimal disturbance of the surface of the flammable liquid. This may be done by lightly 'lobbing' the foam stream, by directing it off a wall at the rear of the liquid container, or by applying it to the ground just in front of an open flammable liquid spill or fire. Foam is water-based: do not use it on fires involving live electrical equipment. Foam is also irritating to eyes.

c. Dry chemical powder (DCP)

DCP extinguishers are primarily used on Class B fires, but can be used on some other types, including fires involving live electrical equipment. Range of discharge is about 5–7m, with discharge duration of about 8–30 seconds, depending on the size of the unit. The powder stream should be applied in a sweeping motion across the flames. Note that re-flash (re-ignition) may occur if the fire is not put out completely or if an ignition source is still present. Though a powerful firefighting agent, DCP has the disadvantage of leaving a powder residue, which may damage some equipment.

d. Carbon dioxide (CO₂)

CO₂ extinguishers are primarily used on electrical and small Class B fires. Range of discharge is only about 1–2 m. CO₂ should be applied with a sweeping motion. It is subject to re-flash and the duration of discharge is about 8–30 seconds. CO₂ makes a loud roaring noise and is intensely cold when discharged.

e. Vaporising liquid

Vaporising liquid is primarily used on electrical fires. Range of discharge is about 2–5 m. It should be applied with a sweeping motion, is subject to re-flash, and has a discharge duration of about 8–30 seconds. BCF extinguishers have been withdrawn from service due to the depleting effect the agent is believed to have on the atmosphere's ozone layer. Substitute agents, such as NAF P–III, are now used in extinguishers. Vaporising liquids chemically react with fire to create by-products, which may be hazardous in a confined space. Some, such as NAF P–III, include 'scrubbing' agents to reduce the effects of such by-products.

f. Wet chemical

Wet chemical extinguishers are designed for use in fires in food deep fryers and similar circumstances. They incorporate a special applicator so that the operator can stand clear of the immediate fire area.

Note: Refer also to the 'Portable fire extinguisher/fire blanket selection chart' attached at **Annex A** to this chapter.

3.4.2 Extinguisher Rating Markings

The labels of extinguishers include a rating marking, which makes it possible to compare the relative effectiveness of different types and sizes of extinguishers.

Various fire regulations, which govern the installation of extinguishers, usually specify the acceptable minimum rating of an extinguisher so that the selection of the most suitable and/or cheapest extinguisher that satisfies particular requirements is made easier. For example, a DCP extinguisher with a 40B rating may be required to be installed. A 'standard' DCP extinguisher of 9 kg capacity may satisfy this need, but a 4.5 kg DCP extinguisher containing a high-performance powder may also have a 40B rating and be much lighter to carry and use.

The rating markings are described below:

a. 'A' rating

If the extinguisher is effective on Class A fires, the rating marking will include the letter 'A'. A number in front of the 'A' indicates how effective the extinguisher is on this type of fire. For example, a 9-litre water extinguisher normally will have a 2A rating: if a multi-class DCP extinguisher has a rating marking including 4A, it means it is twice as effective at extinguishing a standard Class A fire under similar conditions.

b. 'B' rating

If the extinguisher is effective on Class B fires, the rating will include the letter 'B'. A water extinguisher, for example, will not have a B rating. A 9-litre foam extinguisher will typically have a 20B rating. A typical DCP extinguisher may have a rating of 40B, indicating it can extinguish about twice the size of flammable liquid fire as the 20B-rated unit.

c. '(E)' rating

If the rating includes '(E)', it indicates that the extinguisher is safe for use on electrical fires.

d. Multiple ratings

Extinguishers that are effective on a range of classes of fire will include several letters in the rating marking. For example, a multi-class DCP extinguisher might have a 4A40B(E) rating. Similarly, a foam extinguisher might have a 2A20B rating.

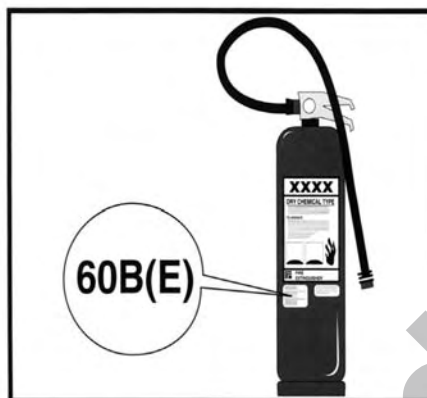

Figure 3:2
Extinguisher rating markings

3.4.3 Rating Tests for Extinguishers

Extinguishers are rated by testing on a range of test fires by an approved authority. For example, the fires used for Class B rating tests use pans of specified sizes and heptane (a flammable liquid) fuel. As a rough guide, a 20B extinguisher should be able to easily extinguish a 2 m² heptane pan fire under test conditions.

3.4.4 Use and Operation of Extinguishers

Practical training experience is the only way to become familiar with the safe and effective use of extinguishers, but some general guidelines are given here.

When using an extinguisher, a good practice is to first discharge it momentarily. This confirms that it is operating correctly and helps you to confirm it is the correct agent, estimate its discharge range and allow for the effect of any wind that is present.

After use, lie all extinguishers on their sides to indicate that they have been discharged and are not available for further use. Immediately send them for recharging, regardless of how little firefighting agent was actually discharged. Where possible, until they are returned, position suitable replacement extinguishers in place of the original extinguishers.

All rescue operators should be familiar with the method of operation of extinguishers they are likely to use.

a. Squeeze handle extinguishers

Most extinguishers are operated by removing a safety pin, or operating a safety catch, on the head of the extinguisher, then squeezing the operating handle, while directing the discharge at the base of the fire. They are sometimes referred to as 'stored pressure' units because the contents are expelled by pressurised air or gas contained within the extinguisher body. The **PASS** acronym describes the operation of this type of extinguisher:

- **P**ull out the safety pin
- **A**im at the base of the fire
- **S**queeze the operating handle
- **S**weep the stream of firefighting agent back and forth across the base of the fire.

Operate these extinguishers upright. Release the handle to stop the stream of firefighting agent if required.

These extinguishers are now the most common type in use. Occasionally you might encounter other types of extinguisher operation, such as the following.

b. Strike knob extinguishers

Operate these by removing a safety pin or cap, or operating some other form of release device, then striking the operating knob at the head of the extinguisher. This action pierces the seal of a gas cylinder mounted within the extinguisher. The released gas drives out the extinguisher's contents, which are directed by the operator onto the fire. Once activated, this type of extinguisher discharges continuously until empty. These extinguishers are also operated in the upright position and are sometimes referred to as 'gas container' type.

c. Reversible extinguishers

Operate these by turning the extinguisher upside down. Some reversible extinguishers (marine type) have a safety device on the head of the extinguisher, which has to be unlocked before it can be operated.

Turning the extinguisher upside down allows two chemicals within the extinguisher to mix and to react to form a gas, which generates enough pressure to drive out the contents. Once activated, this type of extinguisher will discharge until empty or until internal pressure is too low to expel the contents.

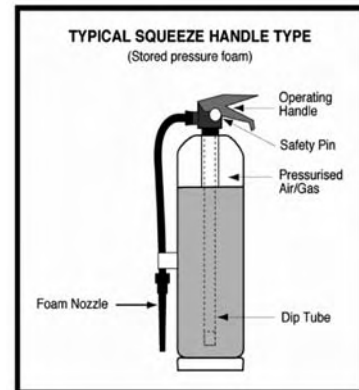

Figure 3:3
Squeeze handle extinguisher

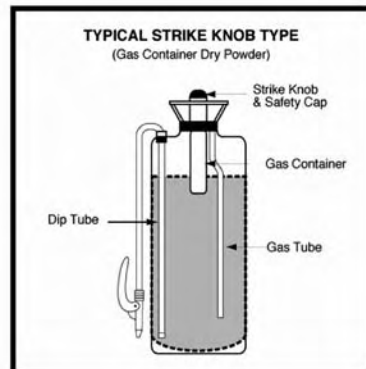

Figure 3:4
Strike knob extinguisher

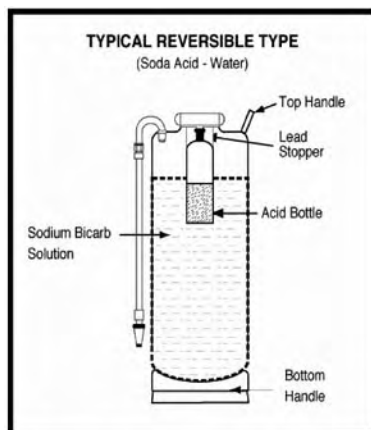

Figure 3:5
Reversible extinguisher

3.5 Priorities During a Fire or Emergency

During any fire or emergency, the overriding priority is to ensure your own survival and safety. You will not be able to assist others if you become a casualty yourself. Your priorities are to:

- a. protect your own safety
- b. help to protect people endangered by the emergency
- c. help to protect property threatened by the emergency
- d. help to restore normality to the affected area.

Each priority requires questions and actions as described below:

a. Protect your own safety

If you are confronted with a fire or emergency, you need to ask yourself:

- i) What sort of fire/emergency is this?
- ii) Do I have the training and equipment to safely handle it?
- iii) What sort of hazards does it involve?
- iv) What precautions do I need to take?

If you are not trained or equipped to control the fire or emergency, or have doubts about this, then you should not try to control the emergency. Leave it to those who are trained and equipped to do so safely. Your main priority is your own safety. Remember, you cannot help anyone else if you become a casualty yourself. There is no property so valuable that it warrants losing your life or risking even a minor injury.

b. Help to protect people endangered by the emergency

If you have decided you can do something to control a fire or emergency, the next questions are:

- i) Is anyone in danger?
- ii) Is there anything I can safely do to help protect them?
- iii) To protect people, is it better to remove the people from the danger, or the danger from the people?

Sometimes, all that is needed is to warn anyone who is in danger and keep people away from the fire or emergency until more help arrives. In some cases, you may be able to eliminate the danger or at least confine it until more help arrives.

c. Help to protect property threatened by the emergency

Once people have been protected, ask yourself:

- i) Is any property in danger?
- ii) Is there anything I can safely do to help protect the property?
- iii) As a protective measure, is it advisable to remove the property from the danger, or the danger from the property?

'Property' refers to anything that may be of value. This does not just mean whether it is worth money or not. Property includes anything of economic, environmental, cultural or heritage value. Sometimes it is possible to remove the threatened property out of the way of the fire or other emergency. On other occasions, you may be able to eliminate the threat to property altogether or at least confine the fire or incident until more help arrives.

d. Help to restore normality to the affected area

Once people and property are out of danger, ask yourself:

- i) Is anything preventing things from getting back to normal?
- ii) Is there anything I can safely do to help restore normality?
- iii) Should priority be given to doing things to make sure the fire/emergency does not happen again or to getting things 'up and running' again?

3.6 First-attack Fire Response Procedures

First-attack fire response procedures involve six steps that should be taken when a fire occurs:

1. Warn anyone in danger

Tell anyone in danger about the fire and warn them to get out of the area.

2. Report the fire to the relevant authorities

Report the fire to the local emergency control organisation and the relevant fire/emergency service, or make sure it has been reported.

3. Decide whether to attack the fire

Decide whether or not to attack the fire, based on the four 'Ss':

Support—Never fight a fire alone. Always have someone backing you up and/or getting help for you.

Size—Unless you are very experienced, a fire bigger than about 1 m by 1 m is too large for you to combat using first-attack firefighting skills.

Surroundings—Hazardous chemicals or sealed containers (for example gas cylinders and aerosol cans) may suddenly explode or give off very toxic fumes in a fire. Such fires are too dangerous for you to combat using first-attack firefighting skills.

Smoke—If there is a danger of smoke, fumes and heat affecting you, the situation is probably too dangerous for you to combat using first-attack firefighting skills.

4. Select the correct firefighting agent and equipment

If it is safe to attack the fire, select the most appropriate agent and equipment to use according to the type of material that is burning.

5. Safely attack the fire

- Attack the fire from upwind if it is out of doors or in a breezy area (that is, the wind should not be blowing the smoke towards or near you).
- Attack the fire from uphill if it involves spilled flammable liquids.
- Do not open a door that is hot or shows signs of fire behind it.
- Always have a safe escape route available to you.
- Check your equipment before committing yourself to firefighting.
- Keep low and stay clear of smoke, fumes and heat.
- Fight the fire from a safe distance, using the maximum effective range of your equipment.
- Lie used extinguishers on their sides to indicate they are discharged.
- If the fire is not being safely extinguished, evacuate the area, closing doors behind you when you and other occupants are clear.

6. Follow the correct procedures after the fire is out

- If possible, do not disturb the fire area. This allows the cause to be more easily determined.
- Keep out of smoke and affected areas, even if the fire appears to be out.
- Do not reoccupy the area until the responsible firefighting organisation declares it safe.
- Arrange for any equipment used to be serviced and recharged.

3.7 Working and Moving in Smoke

Working in smoke is extremely dangerous and should be avoided. If working under these conditions, wear self-contained breathing apparatus and use safety lines for protection.



































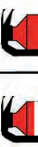
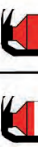

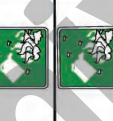

















Under emergency conditions, rescuers may have to enter a smoke-affected area to conduct a rescue. On these occasions, keep close to the floor, work in pairs, and be monitored by rescuers outside in clear air.

Archived

Annex 'A'—portable Fire Extinguisher/fire Blanket Selection Chart

This chart has been reproduced courtesy of SAI Global from AS 2444:2001 Portable fire extinguishers and fire blankets—Selection and location.

The complete standard is available from www.saiglobal.com/shop.

Type of extinguisher		Type of Fire, Class and Suitability							Comments
		A	B	C	E	F	D**		
Colour scheme	Extinguishant	Wood, paper, plastics, etc	Flammable liquids	Flammable gases	Energized electrical equipment	Cooking oils and fats	Metal fires		
 AS/NZS1841 -1997	 Water							Dangerous if used on flammable liquid, energized electrical equipment and cooking oil/fat fires	
	 Wet Chemical							Dangerous if used on energized electrical equipment	
	 Foam***							Dangerous if used on energized electrical equipment.	
	 Powder							Special powders are available specifically for various types of metal fires (see **).	
	 Carbon Dioxide							Generally not suitable for outdoor use. Suitable only for small fires.	
	 Vaporizing Liquid							Check the characteristics of the specific extinguishant.	
	 Fire Blanket								

* Limited indicates that the extinguishant is not the agent of choice for the class of fire, but that it will have a limited extinguishing capability.
 ** Class D fires (involving combustible metals). Use only special purpose extinguishers and seek expert advice.
 *** Solvents which may mix with water, e.g. alcohol and acetone, are known as polar solvents and require special foam. These solvents break down conventional AFFF.

FIGURE A1 PORTABLE FIRE EXTINGUISHER/FIRE BLANKET SELECTION CHART

CHAPTER 4

ROPES, CHAINS AND SLINGS

4.1 Introduction

Rescue incidents call for the use of ropes of various types for rescue rigging applications, and for chains and heavy-duty slings for haulage, anchorage and lifting purposes.

4.2 Record Systems

Clearly and permanently identify all ropes, chains and slings and keep a record of individual items, their usage, inspection and maintenance. Suggested headings for a record system are:

- a. identity number
- b. item description
- c. acquisition date
- d. usage date
- e. description of usage
- f. inspection date
- g. inspected by (name)
- h. maintenance carried out
- i. signature.

If faults are found during any inspection, take immediate steps to rectify the problem(s) in accordance with appropriate Australian Standards.

4.3 Rope

Rope is one of the most important tools of the rescue team, and rescuers use a range of rope types for specific applications. All types have their advantages and disadvantages, and the rescuer requires a thorough knowledge of the characteristics and capabilities of each type. All will give valuable service provided they are appropriately cared for, inspected and maintained.

The strong recommendation is to use only synthetic fibre, kernmantel pattern, static ropes that comply with AS 4142.3 for life rescue purposes, despite the fact that the Australian Standard has not yet been adopted by all rescue services.

4.4 Types of Rope

The ropes in common use by rescue teams can be categorised as follows:

- a. rescue ropes including nylon fibre rope (kernmantel) and climbing tape
- b. general purpose rope including synthetic and natural fibre rope, and
- c. flexible steel wire rope (SWR) and Plasma rope.

4.5 Terminology

For the purpose of this manual, the following terms are used in reference to rope and rope management. Other terms may be used by specific organisations.

Anchor:	To fasten a rope to a suitably secure object.
Belay:	To control a safety rope attached to personnel or equipment as a backup in case of primary system failure.
Bend:	To fasten a line to another line or object.
Bight:	A simple bend in which the rope does not cross itself (see Figure 4:1).
Breaking force:	The averaged ultimate breaking point of rope, expressed in kilograms or in kilo-Newtons, following rigorous testing. Previously referred to as breaking strain or mean breaking load.
Frapping:	The binding together of a lashing between two poles.
Haul:	To pull on a rope.
Hitch:	A closed loop on a rope; a simple fastening of a rope around some object by winding and crossing one turn so that one section of the rope bites on the other without actually knotting the rope.
Kernmantel:	A style of construction of synthetic fibre rope, consisting of a core (kern) and a sheath (mantel).
Marry:	To twist the running end around the standing part, in the same direction as the lay of the rope.
Mouse:	To tie a piece of cord or wire across the jaws of a hook to prevent a rope or sling from jumping out of the hook.
Parcel:	To wrap a section of rope to prevent chafing against an object.
Pay out or ease:	To reduce the tension on a rope to allow it to pay out or slacken.
Reeve:	To thread a rope through pulley blocks.
Round turn:	One complete turn of a rope around a spar or another rope (see Figure 4:1).
Running end:	The free or working end of a rope (see Figure 4:1).
Safe Working Load (SWL):	The maximum working load which should be applied to a rope, consistent with the factor of safety recommended for the conditions under which the rope is to be used.
Standing part:	The part of the rope which is taking the load or which is static (see Figure 4:1).
Whip:	To bind the end of the rope with twine to prevent unlaying or fraying.

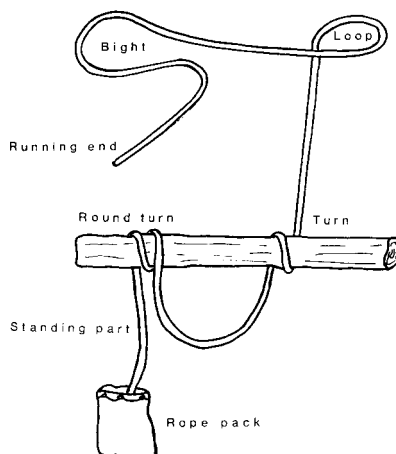

Figure 4:1
Common roping terminology

4.6 Synthetic Fibre Rescue Rope

4.6.1 Construction

The manufacture of synthetic fibre rope starts with a chemical process, which produces the raw material, such as nylon, terylene or, more recently, Plasma or Spectra. The material is then melted and extruded through holes in a metal disc to produce long and fine filaments.

The filaments are then stretched and cooled, with the amount of stretch determining some subsequent rope properties. In basic terms, higher stretching during filament manufacture will result in a rope with higher tensile strength and lower stretch in use.

The filaments are then bunched to form multi-filament yarns. Synthetic rescue rope should be of 'continuous filament' or 'multi-filament' construction, with each filament being a continuous length throughout the rope. It is generally easier to detect a continuous filament rope, as it will be smooth and shiny in appearance, without the 'hairy' appearance of 'staple' or short-filament ropes.

The multi-filament yarns are twisted to form primary strands and twisted together again to make plied strands. The plied strands are then laid together and encased in a plaited sheath (Figure 4:2). Ropes of multi-filament kernmantel construction are manufactured from polyamide fibre with a limited stretch factor and high static strength, making them ideal for rescue purposes.

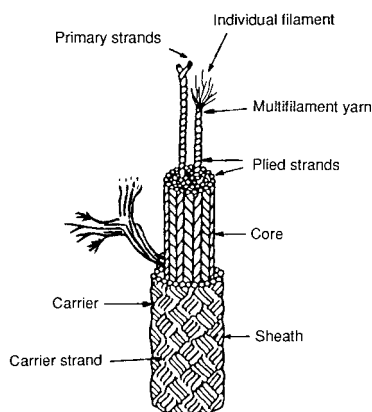

Figure 4:2
Kernmantel rope construction

4.6.2 Polyamide (Nylon)

There are several different types of polyamide. The two most commonly used in the manufacture of rescue rope are Nylon 6, also known as Perlon, and Nylon 6.6.

- a. **Advantages** of polyamide over polyester (terylene) and other rope filaments are as follows:
 - i) Polyamide is about 10 per cent stronger than polyester.
 - ii) Polyamide has excellent shock absorption characteristics.
 - iii) Nylon 6.6 has one of the highest melting points, at around 260 degrees Centigrade.
- b. **Disadvantages** of polyamide are:
 - i) It may lose up to 15 per cent of its strength when wet (and regain this loss on drying out).
 - ii) It is readily affected by contamination by acids.

Polyamide ropes are commonly used in life-support applications, including rescue, climbing and caving.

4.6.3 Plasma

Plasma or Spectra rope is markedly stronger than nylon, with far less stretch resulting in poor shock absorption properties. Plasma is typically 30 per cent stronger than the equivalent size in SWR.

Plasma is a plaited rope, which can be have a loop created in the end by pushing apart the weave to allow a loose splice.

4.6.4 Kernmantel Construction

The term 'kernmantel' comes from a compound German word 'Kern' (core) and 'Mantel' (sheath). The kernmantel style of construction, therefore, consists of a kern or core of filaments designed to sustain the greater part of the load. This core is covered by a woven or braided sheath, which supports a lesser portion of the load but which provides protection for the core against abrasion, dirt and sunlight (ultraviolet light).

This construction style provides a rope that is strong and resistant to damage, yet is light and easy to handle. These ropes also tend to be highly resistant to spin or twist.

4.6.5 Static Kernmantel Ropes

- a. **Elongation**—A static rope is one designed with low elongation characteristics. These ropes normally elongate by about 3 per cent under one person's body weight, and not more than 20 per cent at ultimate breaking point.
- b. **Elasticity**—The stretch in a static rope is normally attributable to the elasticity of the rope filaments. Static ropes have poor shock-absorbing qualities, and any shock loading subjects the rescuer's body, the equipment in the system and the anchor system to high impact forces.
- c. **Strength versus handling**—Static ropes tend to have thicker sheaths for greater core protection. The increased sheath contributes more to the overall rope strength, but results in a stiffer rope with poorer rope handling characteristics.

- d. **Advantages** of a static rope:
- i) low stretch
 - ii) resistance to abrasion and intrusion of damaging dirt and grit, and
 - iii) high tensile strength.
- e. **Disadvantages** of static ropes:
- i) poor capacity for shock absorption, and
 - ii) stiffer handling and knotting.

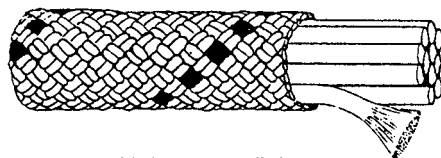

Plait on parallel core

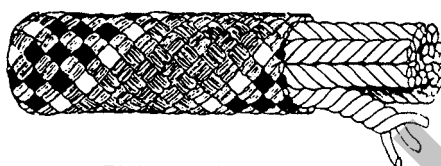

Plait on twisted core

Figure 4:3*Examples of kernmantel rope construction***WARNING**

ALL ROPES USED IN A RESCUE SYSTEM MUST HAVE IDENTICAL CHARACTERISTICS TO AVOID UNEQUAL ROPE STRETCH AND LOAD REACTIONS.

4.6.6 Characteristics of a Synthetic Fibre Static Rescue Rope

The criteria for synthetic fibre rescue ropes are laid down in AS 4142.3:1993, 'Fibre ropes —Part 3: Man-made fibre rope for static life rescue lines', and comprise the following:

- a. minimum diameter of 11 mm
- b. static kernmantel construction
- c. minimum rated strength of 3000 kg
- d. 100 per cent polyamide (nylon)
- e. spin-resistant
- f. abrasion-resistant
- g. good handling and knotting properties
- h. maximum 3 per cent elongation at 80 kg load
- i. maximum 10 per cent elongation at 375 kg load
- j. maximum 20 per cent elongation at 3000 kg load
- k. contrasting core and sheath colours
- l. coded with an identification tape in the core.

4.6.7 Care and Maintenance

Observe the following points:

- a. Avoid cutting a rope unless it is essential to do so. If it is necessary, heat-seal the cut end as soon as possible to prevent fraying. (As a temporary measure, tie a Figure of Eight knot near the end of the rope or secure it with adhesive tape.)
- b. Do not leave knots in a rope as they considerably reduce its strength by seriously damaging the fibres. The exception is Prusik loops. Studies have shown that trying to untie the Double Fisherman's knot in a loop, that has been loaded, does more damage to the rope fibres than leaving them tied. It is recommended that these knots are left in and regular inspections are conducted to ensure that the loop is in a serviceable condition.
- c. Always use proven knots and fastenings for ropes. Sharp bends or knots can overload elements of the rope. Avoid swaged eyes at rope ends.
- d. Use the correct size sheave in pulleys. Any attempt to force a thick rope through a smaller pulley will cause damage.
- e. Avoid shock-loading, sudden jerks or violent stress on the rope.
- f. Avoid stepping or walking on rope, as this will force damaging grit and dirt into the fibres.
- g. Avoid passing a rope over a sharp edge or rough surface. If it is necessary to do this, protect the rope.
- h. Always clean ropes that have been hauled through mud, sand or grit after the work has been completed. The best way to manage this is to wash the rope in fresh, running water, and follow any manufacturers' recommendations.
- i. Do not dry ropes in front of a fire or other heat source. Spread the rope on a ladder, laid horizontally off the ground in a cool, shady area, to enable the air to circulate freely around the rope.
- j. Store ropes under cover, off the floor, preferably in racks in a place free from the extremes of temperature and out of contact with any contaminating materials.
- k. Appropriately label damaged or defective ropes and remove from service immediately. Enter details on the rope history record card.
- l. Do not expose ropes to direct sunlight for prolonged periods, as the fibres will degrade due to ultraviolet radiation. If a rope has to be stored in an exposed location, cover it with a tarpaulin or some other form of protection.
- m. Ensure no contact is made with contaminants such as grease, oil, petrol, hydraulic fluid, acids, alkalis and chemicals.

4.6.8 Washing Ropes

Wash ropes when dirty to reduce the effect of grit abrasion on both the rope and abseil or ascent equipment. Chain the rope (see Figure 4:6) to prevent tangling.

Wash polyamide ropes in a washing machine, but set the machine on the cold or warm setting (never on hot), and do not use washing agents or fabric softeners. Where help is needed to clean a particularly dirty rope, refer to the rope manufacturer's specifications.

The washed rope can be pulled under very slight tension through an in-line descender to remove excess water. Dry the rope in a cool, shady area with good ventilation.

4.6.9 Inspection

Inspect all rescue ropes before, during and after use. Conduct the inspection by visually examining the rope and by thoroughly feeling the rope.

For visual examination, check for the following signs:

- a. **Discolouration of the filaments**—Any changes in the original colour of the rope filaments could indicate contamination by chemicals.
- b. **Melting**—Any smooth areas could indicate the rope has been damaged by heat fusion.
- c. **White filaments**—Where the sheath has been damaged, the white core filaments may protrude.
- d. **Size uniformity**—The rope may be damaged by mechanical impacts or over stressing. This may be evidenced by a change in the obvious shape and diameter of the rope.
- e. **Abrasion**—Excessive signs of abrasion may indicate the breaking of a sheath bundle and localised weakness.

Thoroughly feel the rope and check for these additional signs:

- a. **Stiffened filaments**—This indicates possible overloading or contamination.
- b. **Changes in diameter**— A bight of rope should have uniform radius around the bend. Depressed irregularities in the rope diameter (soft spots) may indicate core damage, while increases in the apparent diameter may be due to severe twisting of the core, or the protrusion of core filaments through the sheath.
- c. **Contamination**—Presence of dirt or other materials.

WARNING
LOAD TESTING OF ROPES IS NOT RECOMMENDED AS A SAFE PRACTICE.

4.6.10 Retiring a Rope

It is currently impossible to properly test a rope without destroying it. The decision to retire a rope from service must therefore be based on careful inspection by a competent officer. The following guidelines will assist in deciding when to retire a rescue rope:

- a. **Abrasion**—As a general rule, when more than half of the sheath yarns are broken or the abrasion 'fuzz' stands out from the sheath more than 25 per cent of the rope diameter.

- b. **Loading**—Retire the rope if the rope is known to have sustained a shock loading or to have been overloaded.
- c. **Contamination**—Unless the material with which the rope has come into contact is known to be harmless, consider the rope as contaminated.
- d. **Texture**—A lack of uniformity of texture such as soft or hard spots.
- e. **Diameter**—Variations in the observable diameter of the rope such as ‘hourglass’ narrowings, which indicate core damage.
- f. **Sheath penetration**—Where the white core filaments are visible through a hole in the sheath, or where the core protrudes through the sheath as a white filament ‘puff’.

While some services may have a policy on the life or limit of use of a rope, the bottom line with regard to rope retirement must always be:

WARNING
WHEN IN DOUBT RENDER IT UNUSABLE AND THROW IT OUT.

4.6.11 Identification

A system of marking each end of a rope for identification of length and with a reference number to the rope history card is recommended.

4.6.12 Rated Strength and SWL

The rated strength of rescue ropes is shown in Table 4:1.

Note: For synthetic fibre rescue rope only, Standards Australia recommends that a safety factor (SF) of not less than 8 be considered as an appropriate margin of safety to reflect ageing, environmental effects and less than ideal usage, including the tying of knots in the rope during its use.

WARNING
USERS MUST ENSURE THAT EQUIPMENT USED IN CONJUNCTION WITH THE ROPE IS SUITABLE FOR THE TASK IT IS REQUIRED TO PERFORM.

Rope diameter (mm)	Breaking force (kg)	Safe working load (kg)
11	3000	375
13	3600	450
16	4500	562

Table 4:1
*Breaking force and SF8 safe working load
 (from Standards Australia)*

4.6.13 Rope Packaging

A number of techniques are suited to the packaging of rescue ropes. These include:

- a. stuffing
- b. hanking, and
- c. chaining.

Packaging techniques are as follows:

- a. **Stuff Sacks**—These are the preferred method of storage and carriage for long-length ropes. First, tie one end of the rope to the sack and, as the name implies, merely stuff the rope into the sack and gently tamp down. The sacks can simply be bags, or packs with straps for carriage to the site. A well-trained operator will be able to feel and visually inspect the rope as they stuff it.

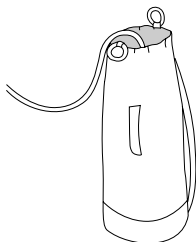

Figure 4:4
Stuff sack

- b. **Hanking the rope**—This is effective for 50 m or shorter lengths, and is quite effective with doubled ropes. Grasp the rope about 2 m from one end and, at full arm-span distance, form bights in the rope, laying them on alternate sides of your hand. Continue until 4 m from the other end. Frap the next 2 m around the bundle of rope just beneath your hand, working up towards your hand. With the remaining 2 m, push a bight through the hole where your hand was (between the frapping and the doubled rope bight), invert it over the head of the hank and pull tight (see Figure 4:5). A well-trained operator will be able to feel and visually inspect the rope with this method, too.



Figure 4:5
Hanking a rope

- c. **Chaining**—This technique can be used for ropes of any length, and reduces the final length of the packaged rope. This is useful when washing ropes in a washing machine or for operational packaging. The rope can be chained as a single length, or doubled and then re-doubled as shown in Figure 4:6.

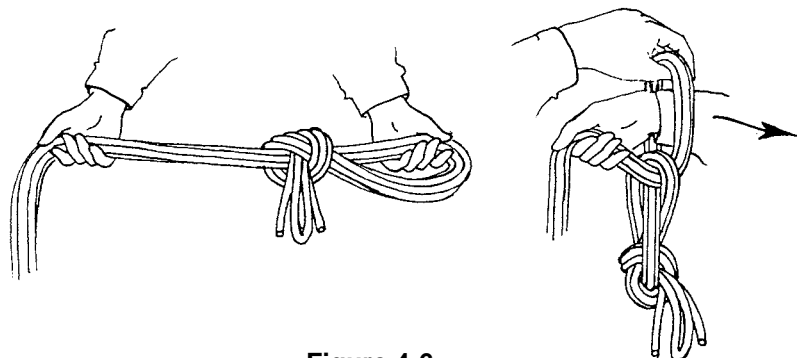

Figure 4:6
Chaining a rope

4.6.14 Carrying the Rope

Sacked ropes are easy to carry where the sack is fitted with rucksack straps. Carry coiled or hanked ropes as shown in Figure 4:7. Carry chained ropes in packs, or draped over the shoulder.

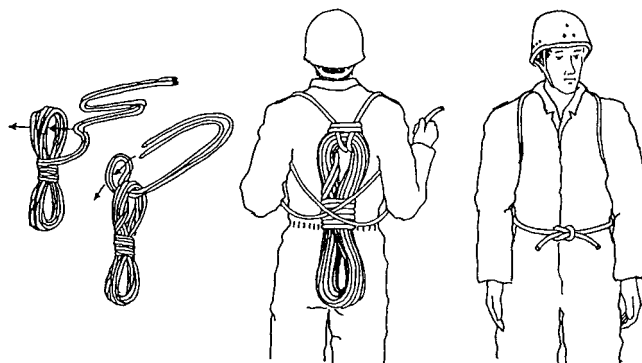

Figure 4:7
Carrying a hanked rope

4.6.15 Flaking the Rope

Regardless of the manner in which the rope is stored or carried, inspect the rope and flake or lay it out for deployment on a tarpaulin or on clear ground to ensure that it will pay out without knots or tangles.

4.7 11mm Polyamide Dynamic Climbing Ropes

These ropes are exclusively made from polyamide and are constructed in kernmantel style with very high elongation (stretch) potential, giving the capability to absorb the high shock loadings imposed by a falling climber.

Climbing ropes are highly specialised, and are used for specialist purposes in vertical rescue operations.

4.8 Small Diameter Kernmantel Cords

A wide range of static kernmantel cords is manufactured for climbing, caving and vertical rescue applications, in diameters from 5 mm to 9 mm. These are specialist ropes, but they can be used for a range of disaster rescue tasks.

The mean breaking loads of these cords will vary between manufacturers, but typical ratings for the most common diameters are:

6 mm	700–750 kg
7 mm	1000–1200 kg
8 mm	1200–1500 kg
9 mm	1600–1800 kg

Table 4:2
Kernmantel rope mean breaking loads

4.9 Climbing Tape

Tape or webbing is one of the most versatile materials available to rescuers. It is used as tied or sewn slings, and its applications are limited only by the imagination of the rescuers. Some examples of the use of tape slings in disaster rescue are:

- a. suspension of blocks from derricks
- b. the 'hinge' in a ladder hinge, and
- c. anchorage of a mechanical descent device.

Use tape slings to make improvised harnesses, casualty support systems, anchor attachments and to link rescue tackle together. Tape is normally tied off into slings with circumferences of 1200 mm and 2500 mm, referred to as 'single' and 'double' tape slings. The material is very versatile, and can be used to form slings of any length for specific purposes

For vertical rescue, use only tape made by recognised equipment manufacturers specifically for rescue, climbing or caving.

4.9.1 Construction

There are two broad design categories of tape—flat and tubular. Both types are actually flat in appearance. However, if tubular tape is viewed in cross section, it forms a hollow tube. Standard tubular tape is normally the strongest and most flexible form and is therefore recommended for vertical rescue.

Tape is woven in many different ways, and the characteristics that can be affected by the style of construction are strength, elongation, abrasion resistance and ultraviolet resistance. All these factors are affected by the fibre used and by the weave tension in particular. While a tape with a very tight weave will be very strong, knot retention and suppleness will be poor. Obviously, a good rescue tape must be a compromise of all factors.

4.9.2 Size

Polyamide tape is sized by flat width, with 25 mm and 50 mm being the most commonly used sizes. Smaller tape sizes may be used for some very specialised techniques, but are not normally suitable or safe for rescue work.

4.9.3 Abrasion

Under certain circumstances, tape is liable to abrade or wear more rapidly than rope, and it has no sheath for extra protection. Pay additional attention to wear or friction areas, and discard tapes when doubt exists as to safety.

When tape is tied or sewn into a sling, the theoretical strength of the sling is twice that of the tape used. In practice, this strength is reduced by knot strength loss and other factors, and the actual strength of a tied sling is approximately two thirds of the doubled material rated strength.

4.9.4 The Use of Tape

As previously stated, tape is normally used in the form of sewn, reinforced or tied slings for all manner of anchorage tasks, improvised harnesses, casualty slings and other attachments. Where tape is tied to form slings, the only safe knot is the tape knot shown in Figure 4:8.

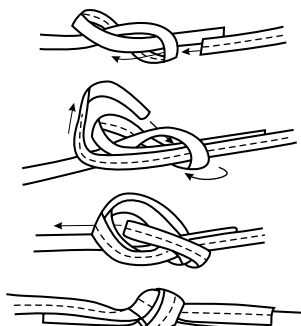

Figure 4:8

The tape knot

The team equipment should include various sized slings. This is the preferred method, as strength loss due to knotting is minimised by the use of a single sling. As a very rapid means of forming a large or extra large sling, join one or more tapes by means of a version of the reef knot as shown in Figure 4:9, or by means of a screwgate karabiner, or preferably by untying the slings and joining them into a large sling with tape knots.

WARNING
ALWAYS CHECK TAPE KNOTS BEFORE USING SLINGS.



Figure 4:9
The reef knot technique for joining tape slings

WARNING
THE LARKS HEAD METHOD OF JOINING TAPE SLINGS AS SHOWN IN FIGURE 4:10 SIGNIFICANTLY REDUCES THE STRENGTH OF SLINGS AND IS NOT SAFE.

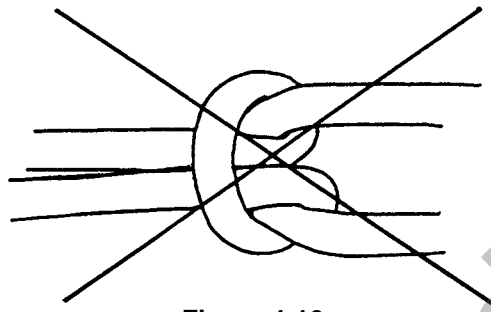

Figure 4:10
The larks head technique for joining slings

4.9.5 Care and Maintenance

Treat tape in exactly the same manner as synthetic rescue rope, subject it to all normal inspections and safety procedures, and record it in the rope record system.

4.9.6 Safety

The following safety points relate to tape:

- a. Many rescuers carry spare slings around their necks when on a task. This is a potentially lethal practice. Should the rescuer fall, the loose slings can snag, resulting in a serious or fatal injury. When slings are carried on operations, preferably carry them on the harness, or diagonally around the neck and under one arm.
- b. Regularly check knots for signs of overstrain or loosening, and properly retie or cut and retie where necessary, with minimum tails of 100 mm.
- c. Regularly and carefully inspect all tape for signs of damage or abrasion, and where damage is suspected, or serious abrasion has occurred, withdraw the tape from service. Where a sling has been subjected to a severe loading, it may be seriously damaged but the damage may not be obvious. Destroy all such slings.
- d. Tubular tape is preferred for rescue, as it is less prone than flat tape to damage on an edge or rough area.
- e. Tape must have the same care as rope. Protect it from abrasion, contamination, friction heat and shock loading, and inspect it before, during and after every use.

WARNING
HOME-SEWN SLINGS ARE TOTALLY UNSAFE AND HAVE NO PLACE IN THE RESCUE ENVIRONMENT.

4.10 Other Synthetic Fibre Ropes

Many other synthetic fibres are used in the construction of ropes of both laid and kernmantel pattern. Ropes constructed of these materials do not comply with AS 4142.3:1993 for static life rescue purposes, but they may still have some rescue applications in a major incident.

4.10.1 Materials

Synthetic materials used in non-rescue rope manufacture may include polyester (terylene), polypropylene, polyvinyl alcohol, polyethylene and polyaramid (Kevlar).

4.10.2 Rated Strength and SWL

In most cases it will be difficult to clearly identify a non-rescue synthetic rope acquired for use in a disaster. For this reason, treat all non-rescue ropes as if they were ropes of natural fibre, and arbitrarily give rated strengths and SWLs appropriate to natural fibre ropes of the same diameters.

4.10.3 Care, Maintenance and Safe Operations

Use and care for these ropes in exactly the same manner as synthetic fibre static life rescue lines.

4.11 Natural Fibre Ropes

4.11.1 Materials

Ropes may be made from a variety of natural materials, the most common of which are manila, sisal, hemp and cotton. Manila and sisal are hard fibres, while hemp and cotton are soft fibres.

Manila and sisal were the two materials used in the manufacture of natural fibre rope for rescue purposes prior to the adoption of the synthetic fibre rope standard. The comparison of manila and sisal fibres follows:

- Sisal has a harsher fibre and therefore makes a stiffer rope.
- New sisal is white in colour, while manila is light brown.
- Both fibres are similar in weight.
- Ropes made of both fibres have similar working loads.
- Sisal absorbs moisture more readily than manila and deteriorates more rapidly. It therefore requires more-frequent inspection.

4.11.2 Construction

Most natural fibre rope is constructed by taking a number of threads or fibres and twisting them into yarns. The yarns are then twisted to make strands and the strands (generally three in number) are laid together to make the finished rope. The number of fibres in the yarns and the number of yarns determine the size of the rope. This type of rope can be left-hand lay or, more commonly, right-hand lay, which is termed 'plain' or 'hawser laid' rop

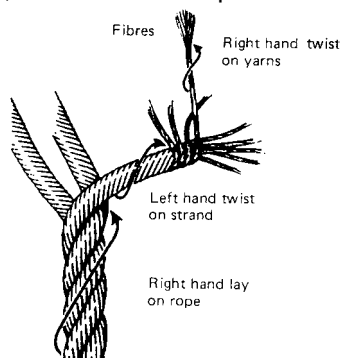

Figure 4:11

Construction of a three-strand hawser laid rope

4.11.3 Care and Maintenance

- a. Avoid cutting a rope unless it is essential to do so. If it is necessary, whip (if laid rope) the cut end as soon as possible to prevent fraying. As a temporary measure, tie a Figure of Eight knot near the end of the rope or apply adhesive tape.
- b. Avoid permanent knots in a rope as they considerably reduce its strength by seriously damaging the fibres.
- c. Avoid, as far as possible, dragging ropes over rough or sharp surfaces.
- d. Always use proven knots and fastenings for ropes. Sharp bends or knots can cause some parts of the rope to become overloaded.
- e. Use correct sheaves in pulley blocks, as any attempt to force thick rope through a narrow sheave will cause damage to both elements. Additionally, use cordage blocks for cordage and SWR blocks for SWR.
- f. Avoid shock loading or overloading of ropes or slings.
- g. Do not step on rope, as this will introduce damaging grit and dirt into the fibres.
- h. Avoid passing a rope over a sharp edge. If this is unavoidable, pad the edge to prevent damage to the rope.
- i. Always clean ropes that have been worked through mud, sand or grit after the work has been completed. Wash the rope with clean running water. Do not use any form of solvent or cleaning agent.
- j. Do not dry ropes in front of a fire or other heat source. Spread the rope on a ladder, laid horizontally off the ground, to enable the air to circulate freely around the rope.
- k. Store all ropes under cover, off the floor, and preferably on storage racks. The store should be free from the extremes of temperature and from any source of moisture, which will particularly affect natural fibre rope.
- l. Keep all ropes out of contact with any contaminating material such as acids, alkalis, solvents and the like.
- m. Try to keep the storage area free of rodents and other vermin.
- n. If a rope has to be temporarily stored in an exposed location, cover it with a tarpaulin or some other form of protection.
- o. Report damaged or defective items as soon as possible, enter details in the record system and ensure the defect is remedied.
- p. Regularly inspect the quality of whipping in laid rope. Repair these as required.
- q. Ensure that natural fibre ropes are not exposed to sunlight for prolonged periods, as they will degrade due to ultraviolet radiation.

4.11.4 Inspection of Laid Rope

It is essential to have sufficient space to handle the full length of the rope in systematic fashion, and to have good light. Inspect the entire length of the rope in sections of approximately 300 mm at a time. Gently twist against the lay to expose the inner surfaces of the strands for inspection. Return the strands to their original positions afterwards. Also carefully inspect the outer layers of the strands.

Check the exterior of the rope for the following:

- broken fibres—abrasions
- cuts
- soft spots—a sure sign of wear
- decay or burns—heat or chemical
- any other deformation or irregularity.

Check the interior of the rope for the following:

- broken fibres
- powdering—indicating internal damage or overloading
- dry rot or mildew
- change in colour
- an odour indicating mildew, rot etc.

4.11.5 Rated Strength and SWL

The SWL of synthetic ropes (including Plasma) can be calculated by dividing the mean breaking load (MBL) by a safety factor of 8.

Natural fibre ropes are manufactured to a tested MBL. Ensure the MBL is clearly displayed on the end plates of the rope drums or on an attached rope identification label.

Calculate the SWL of a natural fibre rope by dividing the MBL by 8, which is considered an appropriate factor for rescue purposes:

$$\frac{\text{MBL (kg)}}{8} = \text{SWL (kg)}$$

A good rule for determining the SWL of all new-condition, non rescue ropes in the field is to square the rope diameter (D, in mm) to provide an approximate SWL (kg):

Example: 16 mm manila rope in new condition
 $D^2 \text{ (mm)} = \text{SWL (kg)}$
 $16 \times 16 = 256 \text{ kg}$

Where the rope has been used, or its new condition cannot be guaranteed, class it as 'previously used rope', and reduce the SWL by a further safety factor of one third:

$$\frac{D^2 \text{ (mm)} \times 2}{3} = \text{SWL (kg)}$$

Example: A new 16 mm manila rope can support 256 kg safely. Previously used 16 mm manila rope will only support 170 kg safely.

When tying a knot or knots in the rope or tying it around a circular object, apply a further reduction of one third of the SWL:

Example: When using a previously used rope around a circular object with a knot or knots in the rope, the calculations for a 16 mm rope to support a load safely are as follows:

New rope value = $16 \times 16 = 256$ kg

Previously used = $\frac{256}{3} \times 2 = 171$ kg

Knots and circular bend = $\frac{170}{3} \times 2 = 114$ kg

Should a turn have to be taken around a square object or over a sharp edge, use a value of one half as the reduction instead of one third. However, pad or round sharp edges if at all possible to eliminate this additional reduction.

4.11.6 Rope Packaging

Large diameter natural fibre ropes cause problems, due to their bulk and stiffness, but as a general rule the hanking and sacking procedures for storage of synthetic fibre rescue ropes are entirely appropriate for ropes of natural fibre.

4.11.7 Whipping Rope Ends

Ensure all laid ropes are whipped with small diameter twine to secure the rope ends. One common whipping technique is shown in Figure 4:12.

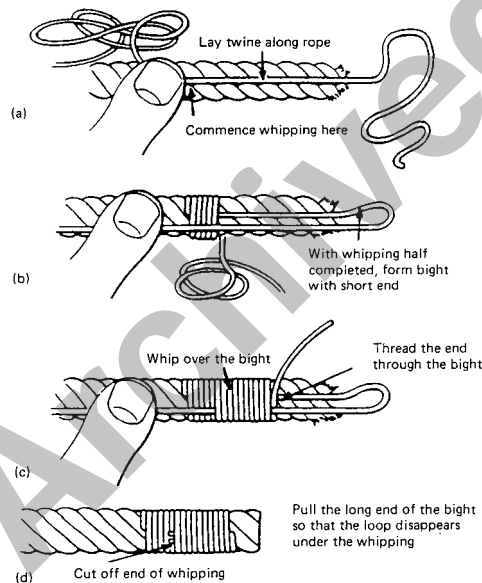

Figure 4:12
Basic whipping technique

Other methods include using electrical tape or heat shrink tubing for whipping.

4.12 Flexible Steel Wire Rope

SWR has many rescue applications, including heavy haulage and lifting, and structural demolition. The most commonly used SWRs are those fitted to vehicle and hand-operated winches.

4.12.1 Construction

SWR consists of a number of strands (normally six) with a fibre core. Each strand consists of a number of steel wires—the most common form of construction being 6/19, indicating 6 strands, each of 19 steel wires, and with a fibre core. During manufacture, wires and strands are either coated with lubricant to prevent corrosion and friction in the rope or they are galvanised.

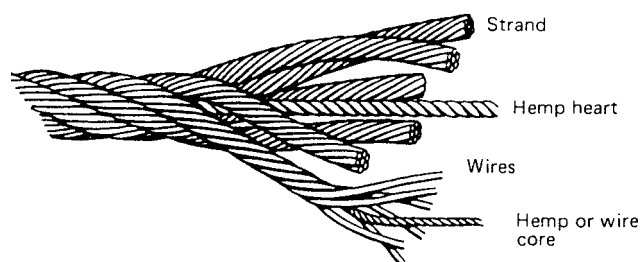

Figure 4:13
Construction of a 6 x 6 SWR

4.12.2 Safe Working Loads

The size of SWR is measured by diameter in millimetres. Once again, a rule for calculating the SWL is given for use in the field in the absence of any manufacturers' specifications. Square the diameter (D) of the SWR, and multiply that by a factor of 8 to determine the SWL in kilograms for the rope.

Example: New 14 mm steel wire rope

$$D^2 \text{ (mm)} \times 8 = \text{SWL (kg)}$$

$$14 \times 14 \times 8 = 1568 \text{ kg}$$

If a SWR is sharply bent, reduce the SWL by one third.

4.12.3 Precautions in Operations

Do not bend wire ropes sharply at any point. As a general rule, the smallest diameter around which a SWR should be bent should be approximately ten times the diameter of the rope—anything less than this will cause damaging uneven stresses on the rope.

4.12.4 Inspection of SWRs

Regularly inspect SWRs in the following manner:

- Check the shackle used with the rope to see that it has not suffered distortion or strain and that the shackle pin is in good condition and easily screwed home by hand.
- Examine the thimble and splice. The splicing cannot be seen, as it is covered by the wire binding or 'serving', but if the binding is loose or shows signs of bulging, it is probable that the splice is starting to come undone.
- Wearing gloves, work along the rope, a hand's breadth at a time, and check that it is reasonably round and that it has not been flattened in use or suffered distortion, which causes the wires to open and thus weaken the rope.

- d. Look for broken wires. Always give prompt attention to a broken wire in a rope. Delay may lead to serious accidents and will certainly cause damage to other wires. The method often used to deal with a broken wire, nipping the wire off with pliers, is not entirely safe, as a small jagged end is left. To save time and trouble, simply bend the wire backwards and forwards with the fingers until it breaks, or, in the case of a short end, use a piece of wood to bend the wire. In this way, the wire breaks inside, instead of outside, the rope and the end is left tucked away between the strands where it can do no harm.
- e. Look for kinks. When a rope has been kinked, the kink may pull out when the rope is stressed, and although it may appear reasonable sound, the structure of the rope has been distorted and damaged. The length affected by the kinking may only be small, but this becomes the weakest part of the rope. The presence of a kink is best detected when the rope is lying slack on the ground. Label and place apart from good ropes a rope of any sort that is found to be defective until it can be examined by a competent person.

4.12.5 Storage of SWRs

Store wire ropes under cover in a clean, dry place and in such a manner that no part touches the ground. Never lay a SWR on concrete or other floors for storage, as these have an adverse effect on the steel. Regular inspection for the presence of corrosion is necessary.

4.13 Chains

Single-link chain slings are commonly used for rescue purposes. All brands have the safe working load stamped on a tag connected to the chain. Always check the tag before using the chain.

Should the information on safe working loads not be available, the following is an approximate rule of thumb method:

$$\frac{\text{Diameter (mm) squared} \times 100}{13}$$

For example, the safe working load for a 12mm chain is calculated as follows:

$$\frac{12 \times 12 \times 100}{13} = 1107 \text{ kg SWL}$$

4.14 Slings

Most modern rescue slings are of the single leg type, with a hook at one end and a ring at the other, or an eye at either end. In all reputable brands, the SWL is clearly marked on an information tag, which will also show safe usage and Australian Standards compliance. Refer to this information before any slinging is undertaken.

The most common types of slings are as follows:

- a. SWR single leg slings, with swaged eyes at each end or with a hook at one end and a ring or eye at the other, to AS 1666 Parts 1 & 2:1995
- b. superflex high-tensile plaited cable slings to AS 1666 Parts 1 & 2:1995
- c. synthetic webbing slings of single leg or round sling design to AS 1353 Parts 1 & 2:1997
- d. polyester round slings with fibre core and braided sheath to AS 1353 Parts 1 & 2:1997
- e. fibre rope slings to AS 1380.1:1998
- f. chain slings of various grades to AS 3775 Parts 1 & 2:2004.

4.14.1 Inspection of Slings

Regularly inspect rescue slings, and inspect after each operational use. Immediately withdraw from service any slings found to be defective, and maintain the record of inspections properly.

Perform an inspection by following these recommended procedures:

- a. Clean the sling prior to inspection. Dirt will hide defects that may be obvious on a clean sling.
- b. Measure each leg of the sling assembly to make sure that the length corresponds with the length stamped on the sling identification tag. An increase in length of more than 3 per cent indicates possible overload damage to a chain sling or other low elongation sling.
- c. Check each link of a chain sling for excessive wear, twisted or bent links, cuts, nicks or gouges, and stretched links. If wear exceeds 15 per cent of the original diameter of the link, remove the chain from service. Consider a 5 per cent stretch on any link as the maximum allowable.
- d. Inspect the master links, couplers, load pins, shackles, swaging and thimbled eyes for wear or damage. If wear on any of these components exceeds 15 per cent of the original materials, remove the sling from service.
- e. Check all stitching or splicing for signs of overload or damage.
- f. If hooks have been stretched out more than 15 per cent of their original opening width, or twisted more than 10 degrees from plane, remove them from service.
- g. Attach a 'Danger—Do Not Use' tag to any sling taken out of service, and repair or destroy the sling as soon as possible.

4.14.2 Precautions in Operations

The method of slinging any given object must vary according to circumstances, but observe certain general rules and precautions to ensure safe operations:

- a. The size and material, and therefore the SWL of the sling, is governed by the weight of the load.
- b. Insert packing between the sling and the edges of the load to prevent the sling coming into contact with sharp edges.
- c. Hooks must be moused, preferably with factory-fitted automatic mouses.
- d. Do not bend wire rope or chain slings around too sharp an angle. Use packing if necessary to prevent this.
- e. Avoid carelessness in hoisting. Particularly avoid shock lifting or snatching loads.
- f. Never drag slings along the floor or ground and never pull slings from under a load which, when lowered, is resting on the sling. Always place timber blocks to receive a lowered load to allow for easy removal of the slings.
- g. A common misconception when slinging is that if the number of legs in the sling assembly is increased, the SWL is the safe load on one leg multiplied by the number of legs in use. This is only true when all legs are in the vertical position.

- h. When rigging with two leg slings, or rigging two slings from anchor points to support a load, the angle formed by the legs must not be more than 120 degrees, and should preferably be less than 90 degrees. The greater the angle, the higher the loading on each leg (see Figure 4:14).
- i. Never shorten slings by knotting, as this will cause excessive bending stresses and may result in damage or failure.
- j. Avoid tip loading of hooks. Open hooks are designed to support the load in the bowl of the hook. Be sure the hook engages freely at the lifting or pulling point so that the weight or force acts along the designed line of force in the bowl of the hook. Forcing the hook tip into the pulling point, where the load does not rest in the bowl, may damage or deform the hook, as well as cause complete failure.
- k. Always remove twists from slings before preparing to pull or lift.
- l. A rescue sling will break for one of two reasons. Either the sling is too light for the force applied or there is a sudden application of a load, which, except for the shock of sudden application, the sling would normally be able to handle. Always lift or pull slowly to reduce shock loadings, and use slings of the correct size.

4.14.3 Slings Loading Angles

When the two legs of a sling system form an angle of 120 degrees, each leg supports 100 per cent of the load. This is due to the fact that the legs start to pull against one another as the angle increases. Above 120 degrees, the tension begins to increase at an alarming rate. At 150 degrees, the load is 200 per cent of the original load on each leg.

Operationally, 90 degrees is a safe relationship between the two legs of the system, and the smaller the angle, the lower the load on each leg. At an angle close to zero (such as when the rope is taken around a pulley), the load on each leg is around 50 per cent of the original load.

This principle for loading angles holds when using a two-leg sling to support a load, when securing a load to two separate anchor points, or when constructing a flying fox. It is a direct relationship of load and angle of attachment.

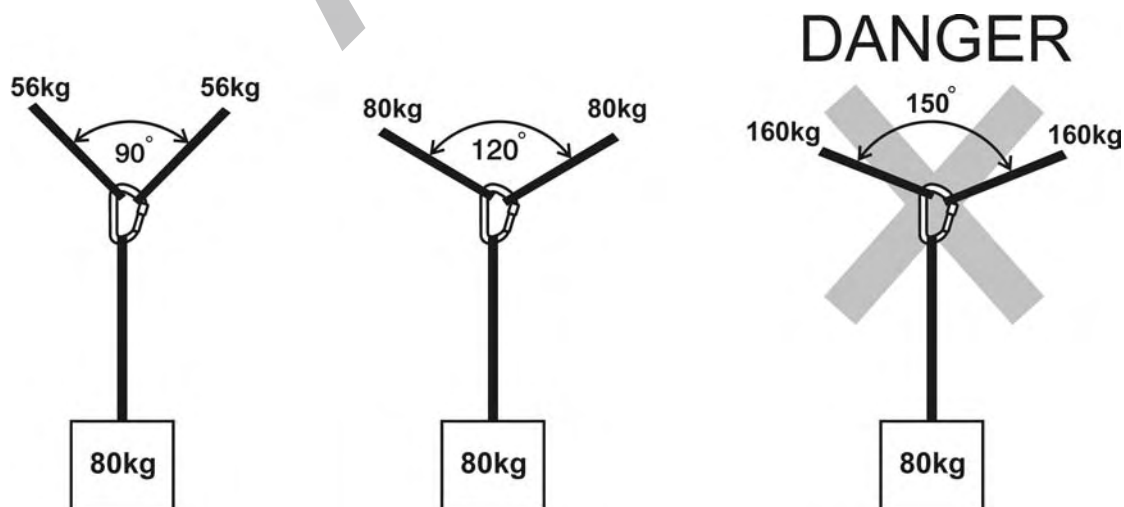

Figure 4:14
Relationship between sling angles and tension

CHAPTER 5

KNOTS AND LASHINGS

5.1 Introduction

Rescue personnel should be familiar with the following knots and by constant practice learn how to make and adapt them with speed and proficiency. Always tie knots tightly, dress them down and inspect them. As a good rule of thumb, any knot that does not look neat and correct is almost certainly tied incorrectly.

It must be clearly understood that not all knots are suited to all types of rope, due to the risk of slippage and knot failure. This chapter therefore covers this subject in three sections, namely:

- a. knots for synthetic fibre rescue ropes (AS 4142.3)
- b. knots for climbing tape, and
- c. knots for general purpose ropes.

The knots suitable for synthetic fibre rescue ropes can all be used with general purpose ropes, but use only the recommended knots for rescue ropes.

5.2 Knots for Synthetic Fibre Rescue Ropes (AS 4142.3)

5.2.1 Thumb Knot

Use the Thumb or Overhand knot at the end of a rope to stop it passing through a pulley, as a security with knots in synthetic rope, or temporarily to prevent the end of a rope from fraying. Form the knot by forming a loop and passing the running end through it.

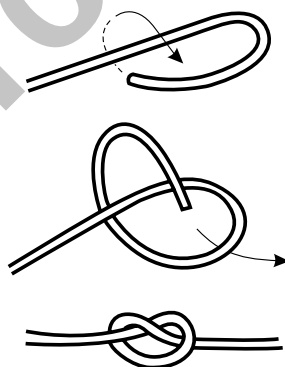

Figure 5:1
Thumb knot

5.2.2 Figure of Eight Knot

Use this knot in the same manner as the Thumb knot to prevent a rope end running through a pulley, or fraying, or to secure a knot tied in a synthetic rope. In general, it is more useful than the Thumb knot as it is easier to untie.

With the rope away from you, take the standing part in one hand, palm upwards, and the running end in the other hand. Pass the running end over the top of the standing part, making a loop, then carry on with the running end around the standing part, over the top, then down through the loop that you have formed. Draw the running end tight: the knot should resemble the figure 8.

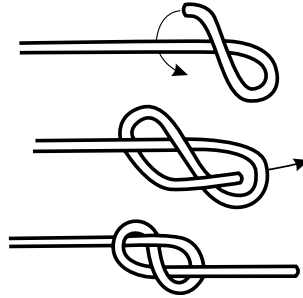

Figure 5:2
Figure of Eight knot

5.2.3 Figure of Eight Loop/Figure of Eight on the Bight

The Figure of Eight knots are the preferred knots for forming end loops in synthetic kernmantel ropes, and are highly suited for this purpose in all ropes. Use them to form a non-slip loop that is easy to undo and has a low percentage deduction from the SWL of the rope.

Tie a single Figure of Eight knot as described previously. Take the running end and pass it around the object. Take the running end and follow exactly the path back through the knot that the running end took when forming the original Figure of Eight. Dress and tighten to form the Figure of Eight loop (Figure 5:3).

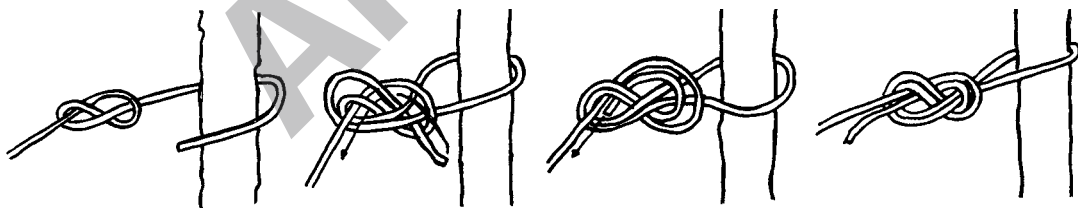

Figure 5:3
Figure of Eight loop

An alternative method where a free loop is required at the rope end is to double the end of the rope for about 500 mm. Tie off this doubled rope in the same manner as the Figure of Eight knot to form a locked bight. This knot is known as the Figure of Eight on the Bight (Figure 5:4).

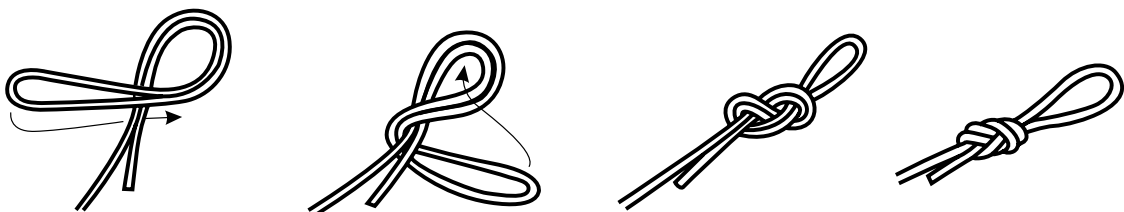

Figure 5:4
Figure of Eight on the Bight

5.2.4 Alpine Butterfly

This is a very strong and useful knot for forming a locked loop at any point of a synthetic or natural fibre rope. There is some confusion in literature as to what constitutes an Alpine Butterfly. The knot shown in Figure 5:5 is correct in that it forms a locked loop which can sustain a three-way loading.

Pick up a bight of rope and twist the bight twice in the same direction, holding each of the cross-overs. Pass the free end of the loop behind the cross-overs and down through the opening formed between the two cross-overs. Cradle the knot in one hand and pull on each side of the loop to dress and tighten the knot.

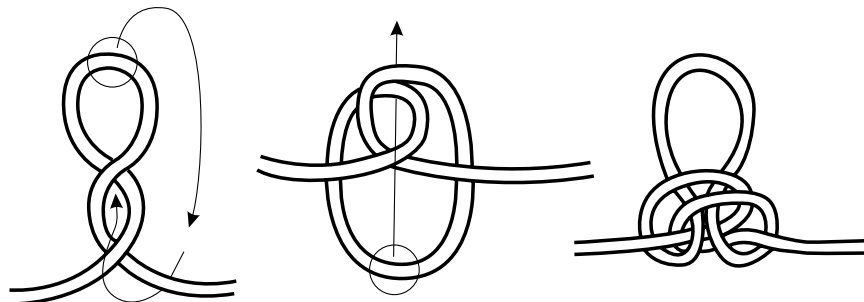

Figure 5:5
Alpine Butterfly

5.2.5 Round Turn and Two Half-hitches

Use this knot to secure the running end of a rope to a spar or ring. It is suited to both synthetic and natural fibre rope. Form it with a Round Turn on the spar or ring, with two Half-hitches on the standing part of the rope. It has the great advantage of allowing a load to be adjusted using the Round Turn, then finally secured by forming the two Half hitches on the standing part.

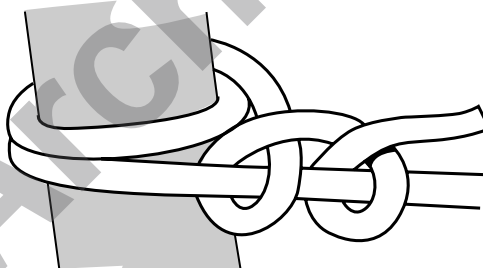

Figure 5:6
Round Turn and Two Half-hitches

5.2.6 Tensionless Hitch

This knot is used to anchor a rope to a tree or similar object. It is created by applying turns around the tree until the friction generated by the turns secures the rope. The knot is finished with two Half-hitches, as in the Round Turn and Two Half-hitches knot above.

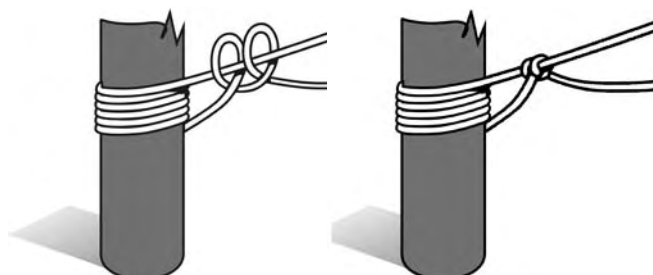

Figure 5:7
Tensionless Hitch

5.2.7 Italian/Munter Hitch

The Italian Hitch (or Munter Hitch) is used as a belaying hitch for lowering and raising. Create this knot by passing a bight through a karabiner and then passing the end through this bight.

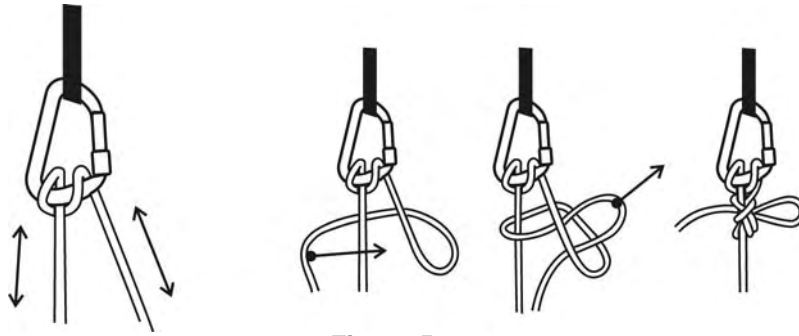

Figure 5:8
Italian/Munter Hitch

5.2.8 Double Fisherman's Knot

This knot is the most commonly recommended method of joining synthetic fibre ropes and can be used to join similar ropes of any material of equal or unequal sizes. Lay both ropes side by side in opposite directions. Make two Round Turns to the left with the right hand running end, and feed the end under the two Round Turns. Make Two Round turns to the right with the left hand running end and feed this end through the two Round Turns. Dress and pull tight.

The Double Fisherman's knot can be very difficult to untie once it has been loaded, but its great strength is a positive advantage in rescue operations.

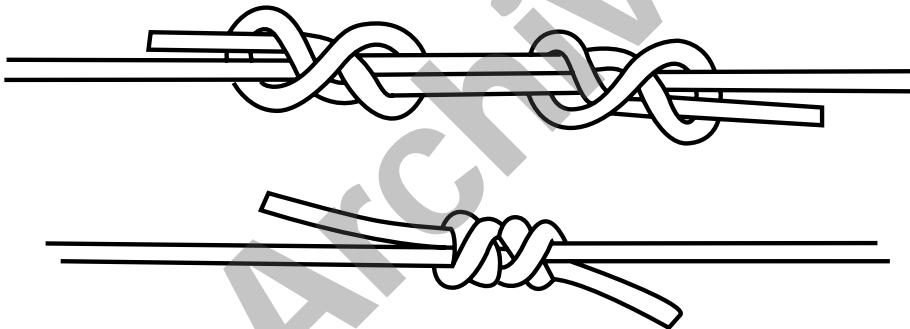

Figure 5:9
Double Fisherman's knot

5.2.9 Prusik Knot

The Prusik knot is a method by which a cord sling can be attached to a rope to provide an attachment loop or hand loop, the position of which can be easily adjusted on the main rope. The cord sling must be at least 3 mm smaller in diameter than the main rope for the knot to work. Never shock load a Prusik knot.

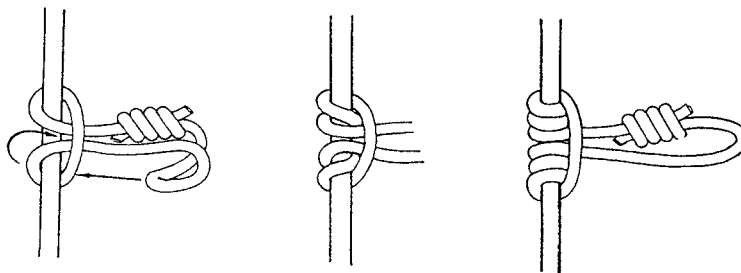

Figure 5:10
Prusik knot

5.2.10 Tape Knot

The Tape knot or Overhand Bend is the only safe method of joining climbing tape. Tie one Thumb or Overhand knot near one tape end. Then take the second tape end through the original knot in the opposite direction, as shown in Figure 5:11, and dress the knot. Leave a minimum tail of 75 mm protruding from each end of the knot.

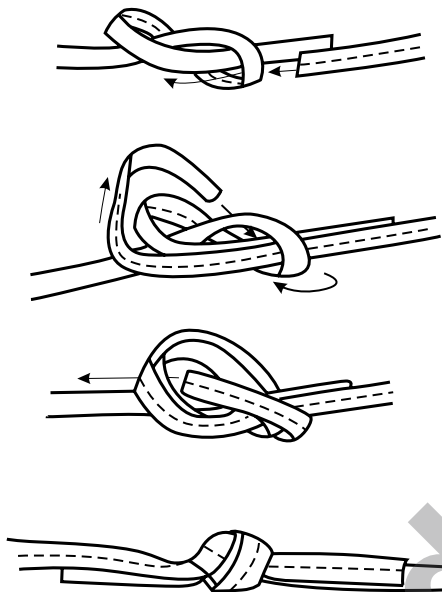

Figure 5:11
Tape knot

5.3 Knots for General Purpose Ropes

5.3.1 Half-hitch

To form a Half-hitch, pass the running end of a rope around a spar (or around another rope) and under the standing part so that, when pulled, one part of the rope binds on the other.

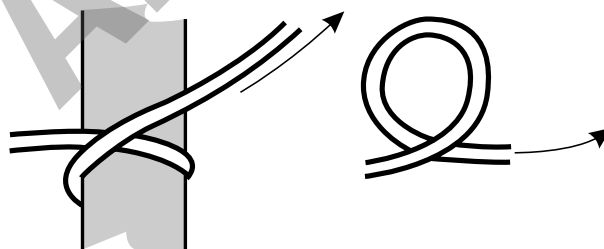

Figure 5:12
Half-hitch

5.3.2 Clove Hitch

This knot is useful for hoisting timbers and rescue tools, and fastening a rope onto a spar at right angles. It is commonly used to start and finish a pole lashing, and can also be formed in the centre of a rope.

To tie a Clove Hitch at the end of a rope (Figure 5:13), pass the running end over the spar, bringing it out underneath the standing part. Pass the running end around the spar again above the first Half-hitch, bringing the running end under itself to tighten, and pull both the running end and standing part. When tied thus near the end of a rope, the Clove Hitch is a good anchoring knot which can be easily untied.

WARNING

DO NOT USE THE CLOVE HITCH AT THE END OF A SYNTHETIC FIBRE ROPE EXCEPT WHEN FORMING A POLE LASHING. KNOT CREEP AND SLIPPAGE WILL BE CONSIDERABLE AND WILL POSE A SAFETY RISK.

To tie the Clove Hitch in the centre of a rope (Figure 5:14), form two loops, one in the left hand (anti-clockwise) and one in the right hand (anti-clockwise), the latter being passed in front of the left hand loop. Then pass both loops over the pole and pull tight.

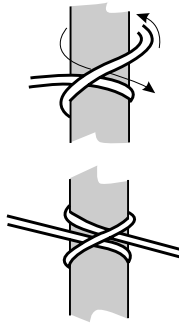

Figure 5:13

Clove Hitch around a pole

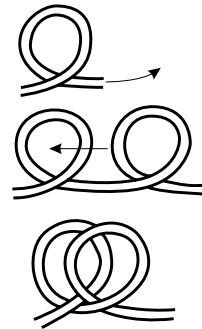

Figure 5:14

Clove Hitch in middle of rope

5.3.3 Timber Hitch

Use this quickly-made hitch to secure a synthetic or natural fibre rope to a plank or spar. Form it by making a Half-hitch on the standing part of the rope, leaving a long end which is twisted for a minimum of three turns with laid rope and five turns with kernmantel rope around its own part of the hitch. When used for lifting spars, planks or poles, use this hitch in conjunction with a Half-hitch at the upper end of the spar (Figure 5:16)

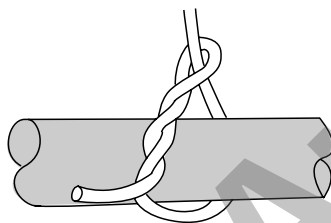

Figure 5:15

Timber Hitch

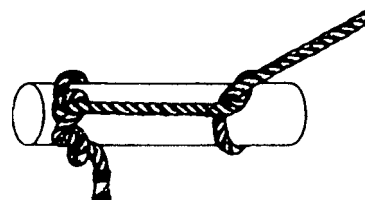

Figure 5:16

Timber Hitch with Half-hitch

5.3.4 Fisherman's Bend

This bend can be used when anchoring lines, and is a variation of the Round Turn and Two Half-hitches. Take a round turn around the anchor point, bringing the running end out under the standing part. Feed the running end through the two turns from the top and finish off with two or more Half-hitches around the standing part.

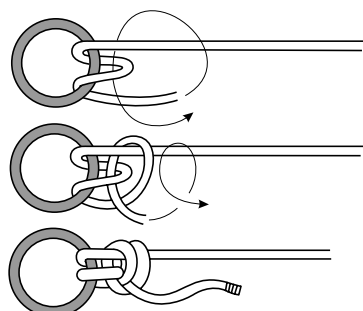

Figure 5:17

Fisherman's Bend

5.3.5 Buntline Hitch

The Buntline Hitch (sometimes incorrectly called the Becket Hitch) is a very strong and compact knot, which can be used to secure the rope end to the becket of a pulley when reeving a tackle. Take the rope through the becket then back around the standing part in a Half-hitch. The second Half-hitch is formed inside the first to form a Clove Hitch, and when the knot is dressed, it is strong, compact and safe.

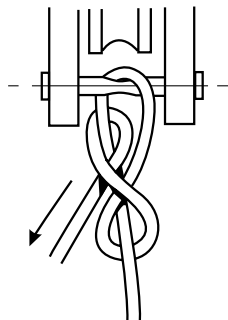

Figure 5:18
Buntline Hitch

5.3.6 Double Sheet Bend

Use this bend to join natural fibre laid ropes, regardless of their diameter. Form a loop in the thicker of the two ropes and hold this in the left hand. Pass the running end of the other rope up through the loop and around both thicknesses of the thicker rope twice, and then under its own standing part without overriding, so that the running ends of both ropes pass out of the knot on the same side.



Figure 5:19
Double Sheet Bend

5.3.7 Bowline

The Bowline knot is only safely suited to laid ropes. It is not safe for use with synthetic fibre ropes of kernmantel construction due to the high risk of knot creep. Use the Figure of Eight loop or Figure of Eight on the Bight for safety.

Hold the rope in the left hand and form a small loop over the top of the standing part. Hold the loop in place with the thumb of the left hand. Then feed the running end through the back of the loop, round the standing part and tuck the end back through the loop. Dress and pull tight.

WARNING
THIS KNOT IS NOT RECOMMENDED AS SAFE WHEN TIED IN SYNTHETIC KERMANTEL ROPE.

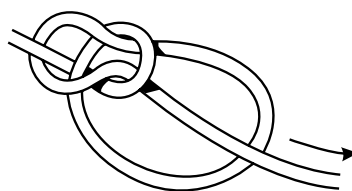

Figure 5:20
Bowline

5.3.8 Bowline on the Bight

This knot is useful for forming a double loop. It can be used to lower a rescuer or victim from heights, or to sling a stretcher in the same manner as the Chair knot. Double the rope end up the standing part to form a long bight and take the doubled rope in the left hand. Using the double rope, form a loop in the top, as in the ordinary Bowline, and feed the main bight up through the loop from behind until you have as much of the bight above the loop as below it. Take hold of the upper bight and bring it down over and behind the lower loop. This produces two lower loops (Figure 5:21). Holding the knot in place, pull on the loops until the knot is tight. This knot needs to be properly shaped and dressed for the function for which it will be used.

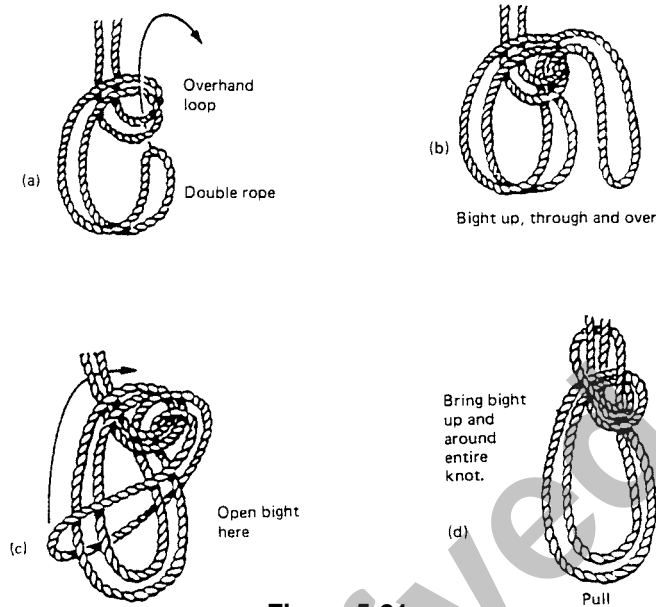

Figure 5:21
Bowline on the Bight

5.3.9 Portuguese Bowline

The Chair knot has traditionally been used as an emergency casualty sling or stretcher sling, but it is not a strong knot. The Portuguese Bowline is preferred for strength and simplicity. Form two (or more) loops at the rope end, and take the running end of rope up through the cuckold's neck, around the standing part and back down through the cuckold's neck in the same manner as the standard Bowline (Figure 5:22). This knot is also known as the French Bowline.

WARNING
THIS KNOT IS NOT RECOMMENDED AS SAFE WHEN TIED IN SYNTHETIC KERNMANTEL ROPE.

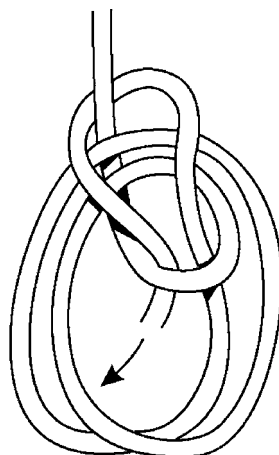

Figure 5:22
Portuguese Bowline

5.3.10 Chair Knot

The Chair knot is useful for rescue work. One of its main purposes is to form an efficient and quickly made sling in which a person may readily be raised or lowered. The sling formed by this knot gives support to the chest and legs of the person being rescued.

Grasp the rope near the centre, so that it lies across both hands. Form two loops (upward): one loop in the left hand clockwise direction, one in the right hand anti-clockwise direction. Now with two loops, one in front of and one behind the rope, overlap them. Pull each loop through the other and adjust them to suit. Tie a Half-hitch around each of the adjusted loops, dress and pull tight.

Initially, loops should be of equal size (knot placed in the centre of the chest and arms extended). Then sling the casualty, one loop under the arms and one under the knees, with the knot midway between nose and knees. Also use the Chair knot as a stretcher sling, by forming a Chair knot complete with Half-hitches in the centre of a 12 m rope. Attach the sling to the stretcher handles by means of Half-hitches, and adjust. The main lowering or hauling rope is normally attached to the Chair knot by forming a Round Turn and Two Half-hitches through the long legs of the knot.

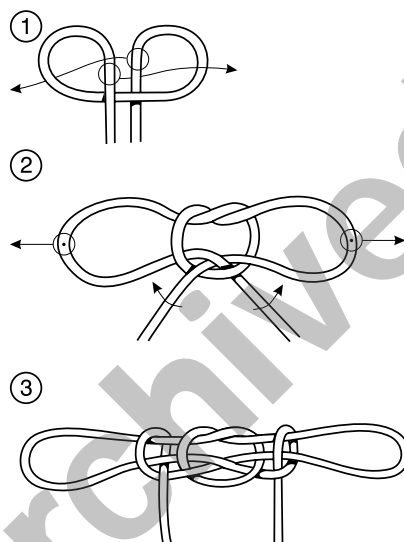

Figure 5:23
Chair knot

5.4 Knot Safety

Observe the following points relating to knot safety in all activities:

- a. Select knots that are appropriate to the task and to the rope in use. This is of particular importance with synthetic fibre kernmantel ropes.
- b. Any knot tied at or near the end of a synthetic fibre rope can be protected with a Thumb knot tied on the inactive side of the knot to prevent slippage.
- c. Tie knots with a minimum tail of 75 mm protruding from the knot.
- d. Monitor and check all knots throughout any operation.
- e. Do not leave knots permanently in a rope, as they will deform the rope fibres and weaken the rope.
- f. Use the Figure of Eight family of knots for all tasks for which the Bowline was traditionally used, due to the risk of knot creep and failure when forming knots in synthetic fibre ropes.

5.5 Knot Strengths

The following chart shows the approximate residual breaking strains of new rope in which rescue knots have been formed. For example, if a Thumb knot was tied in a rescue rope which had a breaking strain of 3000 kg, the rope would now only be able to be loaded to 45–55 % of its original breaking strain (i.e. loaded to 1350 kg - 1650 kg). For this reason, a safety factor of 8:1 is applied to all rescue roped in use. This takes into account the reduction of strength caused by tying knots.

Knots for synthetic fibre rescue ropes (AS 4142.3)

Thumb (Overhand) knot	45–55%
Figure of Eight knot	55–65%
Figure of Eight loop	60–70%
Figure of Eight on the Bight	60–70%
Alpine Butterfly	65–70%
Round Turn and Two Half-hitches	60–65%
Double Fisherman's knot	60–70%
Prusik knot	Not calculable

Knots for climbing tape

Tape knot	60–65%
-----------	--------

Knots for general purpose ropes

Clove Hitch	60–70%
Timber Hitch	60–70%
Fisherman's Bend	60–65%
Buntline Hitch	60–65%
Double Sheet Bend	55–60%
Bowline	60–65%
Bowline on the Bight	60–65%
Portuguese Bowline	60–65%
Chair knot	40–45%

Archived

5.6 Lashings

Mainly use lashings to secure two or more poles firmly together. Carefully study the diagrams and explanations to understand the form of each type of lashing.

5.6.1 Terminology

All poles or timbers in a vertical attitude or which will be raised vertically are known as standards, while those used horizontally are referred to as ledgers.

5.6.2 Square Lashing

Use a Square Lashing to lash together two poles that touch and cross at right angles.

- Stage 1** Start with a Clove Hitch round the standard, below the ledger, and marry the ends. Take the married ends up and around both standard and ledger as depicted by the arrow.
- Stage 2** Repeat this circuit three or four times, working inwards on the standard until the gap is filled, keeping the rope as taut as possible.
- Stage 3** Take three or four frapping turns around the whole lashing between the poles, draw taut and finish with a Clove Hitch on the ledger.

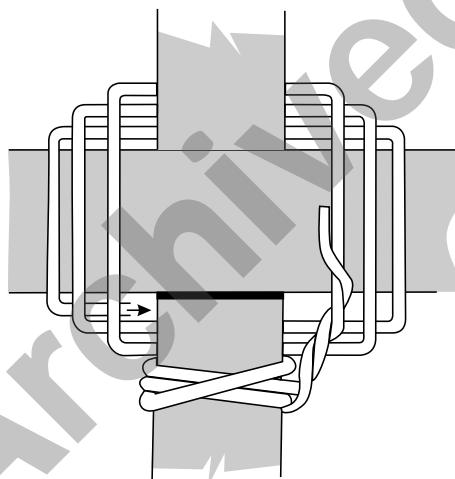

Figure 5:24
Square Lashing

5.6.3 Diagonal Lashing

Use a Diagonal Lashing to lash together two poles that touch at an angle, especially when their mode of use may cause them to spring apart. Start with a Timber Hitch around both poles horizontally, then take four vertical turns and draw taut. Take four horizontal turns and draw taut. Finally, put four frapping turns over the lashing, between the poles, draw well taut and finish with a Clove Hitch.

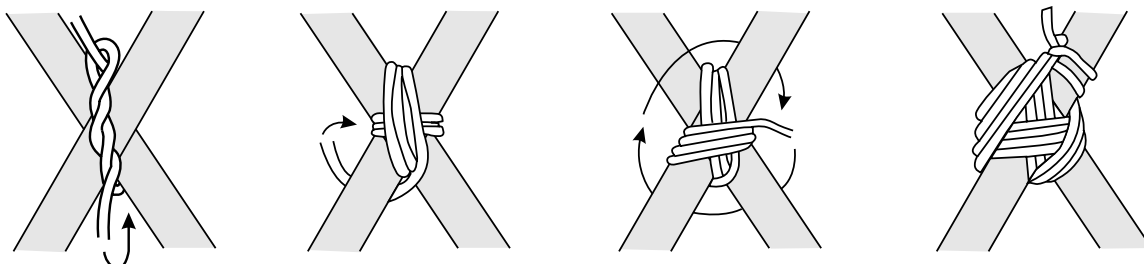

Figure 5:25
Diagonal Lashing

5.6.4 Round Lashing

Use a Round Lashing to lash together two poles that lie parallel to each other. Insert spacing pieces. Start with a Clove Hitch around one pole and continue with six to eight close turns around both poles, travelling upwards. Make two or three frapping turns around the lashing and secure with a Clove Hitch on the opposite pole to the beginning of the lashing. Do not remove the spacing pieces until the lashing is completed.

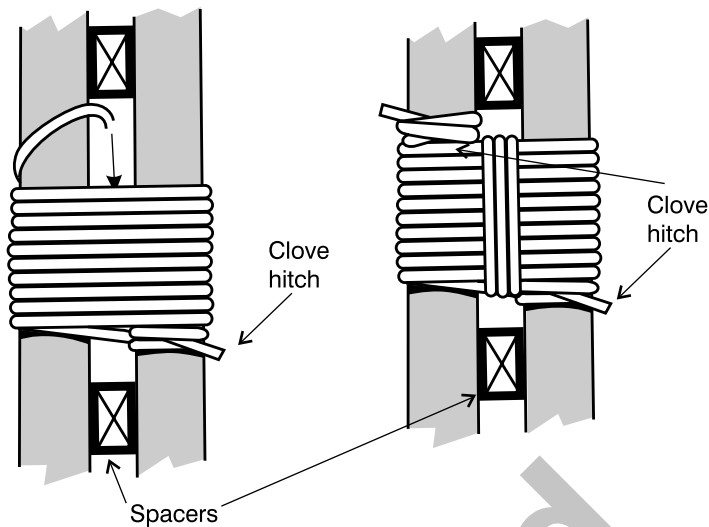

Figure 5:26
Round Lashing

5.6.5 Figure of Eight Lashing

Use a Figure of Eight Lashing to lash three parallel poles together, as may be necessary, for instance, to form a tripod. Insert spacing pieces about 50 mm wide between the poles. Start with a Clove Hitch around one of the outside poles, with the ends married. Working upwards all the time from the first Clove Hitch, continue lashing in figure of eight fashion with six to eight turns. Make two or three frapping turns around the lashings between the poles. Finish with a Clove Hitch on the opposite pole to the beginning of the lashing.

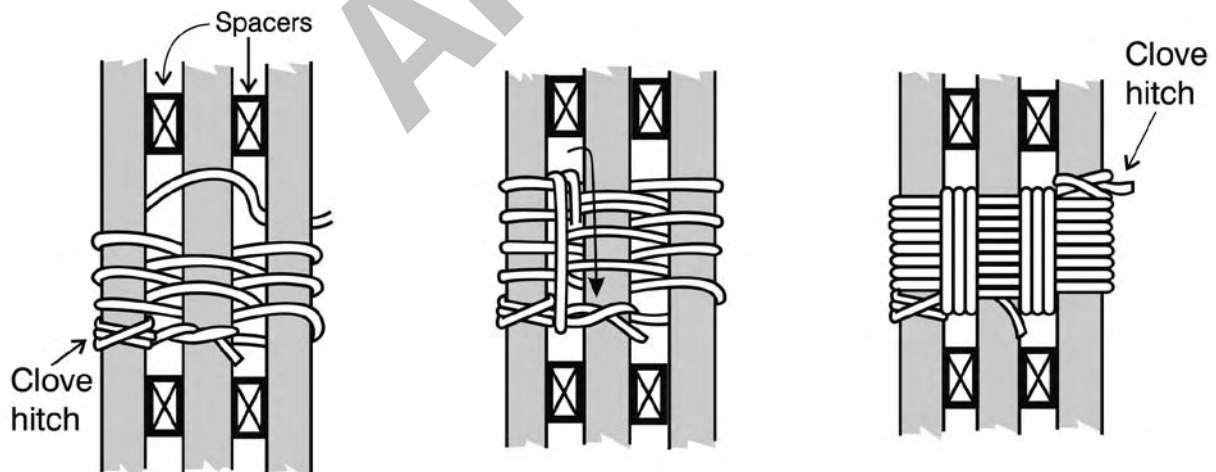

Figure 5:27
Figure of Eight Lashing

CHAPTER 6

LADDERS

6.1 Introduction

Ladders are readily available at most rescue sites and during a disaster may be used for improvised rescue techniques. Remember, however, that ladders have been constructed to be used in a specified, load-bearing position, and should normally be used in accordance with AS 1892.2 and AS 1892.4.

The load rating for portable ladders varies from 80 kg to 150 kg. The preferred rating for rescue services is 150 kg.

6.2 Terminology

The following terminology is standard for ladder operations:

Stiles	The main structural part of a ladder.
Rungs	Cross members used in climbing a ladder.
Single ladder	A one-piece ladder, including rescue ladders.
Extension ladder	A ladder built in sections, one or more of which can be extended.
Folding ladder	A ladder built in folding sections that can be used as a straight ladder or a frame ladder or as a scaffold.
Foot	The bottom or ground end of a ladder.
Head	The top of a ladder.
Hauling ropes	Pulling lines for raising extension ladders.
Latching device	Metal hooks fitted to extension ladders to lock the ladders in extended form.

6.3 Construction

Ladders come in a variety of styles, lengths and materials. Aluminium, timber and fibreglass are the three most common. Recently, carbon fibre and plastic ladders have been developed for rescue use but their use is not widespread yet.

Given the vast variety of manufacturers and load ratings, all ladders should be used with due consideration to the respective load ratings of the particular ladder in use.

6.4 Types of Ladders

6.4.1 Straight Ladders

Straight ladders have one section consisting of stiles and rungs and can be extremely useful as they can be made to support rescue loads when used for bridging gaps.

6.4.2 Extension Ladders

Extension ladders are commonly in two sections, with the upper section sliding on and between the stiles of the lower section. Latching devices are fitted to the lower end of the upper section and operate on a movable shaft. Hauling ropes are taken through a sheave fixed near the top of the lower section, and are brought down and fastened to hooks or cleats at the bottom of the upper section. One cleat is attached to the latching device shaft, thus providing an endless line by means of which the top section can be extended and the latching devices, which are mounted on the upper section, can be engaged or released.

To easily distinguish them in the dark, the stiles of the top section should bear a white line to indicate the limit of safety when extended for use.

Timber ladders are strengthened on the underside of the stiles by galvanised wire or fibreglass, which is stretched tautly in the groove along the edge of the strings being secured top and bottom.

Timber ladders are further strengthened by cross ties from stile to stile at intervals.

Do not paint ladders, as paint can hide incipient defects. A small section at each end may be painted for identification purposes. Timber ladders may be treated with linseed oil.

Withdraw defective ladders from service and label '**Dangerous—Do not use**'; repair or destroy as soon as possible.

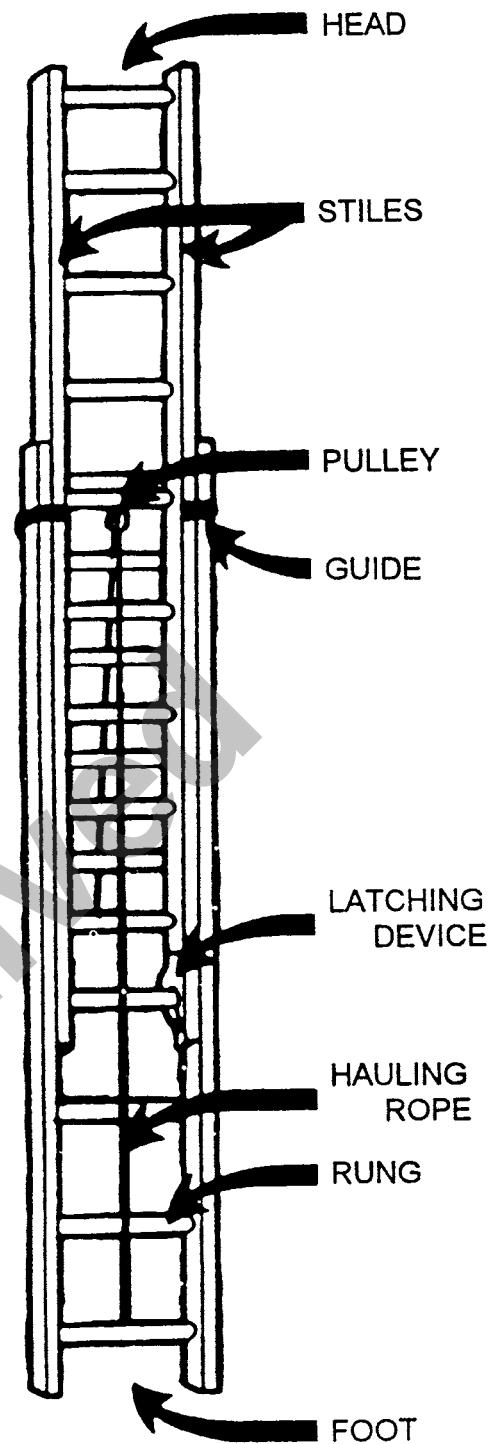

Figure 6:1
Parts of a ladder

WARNING

A HAZARD EXISTS WHEN USING LADDERS IN THE VICINITY OF ELECTRICAL WIRES, AS ALL LADDERS HAVE THE POTENTIAL TO CONDUCT ELECTRICITY FROM WIRES OR 'LIVE' ROOFS OR STRUCTURES. ENSURE OVERHEAD CLEARANCE WHEN ERECTING A LADDER.

6.4.3 Folding Ladders

Some manufacturers have developed folding ladders that can be shaped as a straight ladder, as an 'A' frame or as a raised work platform. While these can be very useful for rescue, care must be taken not to exceed the manufacturer's parameters during operational use.

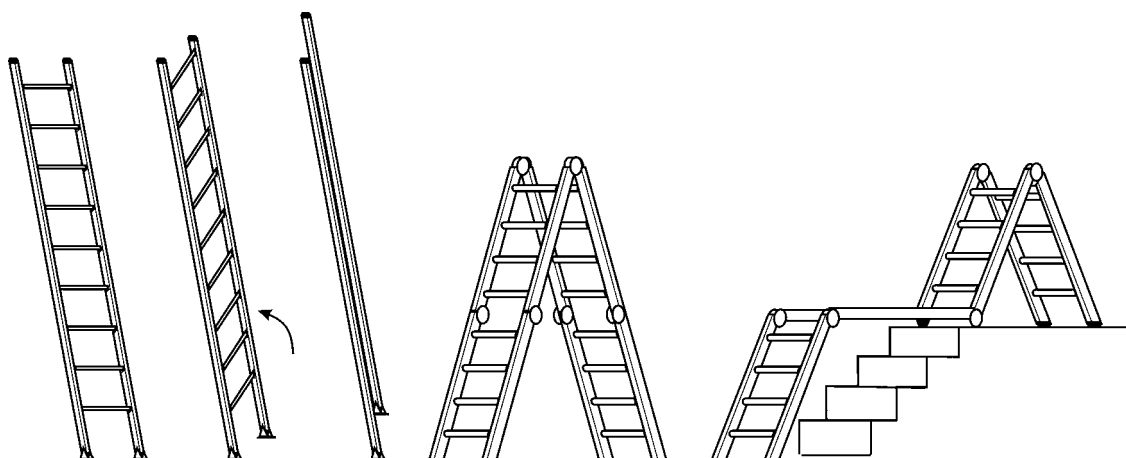

Figure 6:2
Folding ladders

6.5 Using Ladders

6.5.1 Single-rescuer Ladder Raise

A single rescuer can quite easily and safely raise a short ladder. Place the ladder foot against the base of the wall or some other stationary object, and 'under-run' the ladder by walking in and pushing forward and upwards on alternate rungs.



Figure 6:3
Single-rescuer ladder raise

6.5.2 Erecting and Extending the Ladder (Three Rescuers)

Ideally three rescuers form a ladder team. Rescuer 1 is responsible for the foot of the ladder, both in carrying and positioning where necessary. Rescuers 2 and 3 support the uppermost stile of the ladder on their shoulders.

On arrival at the site, Rescuer 1 places the foot of the ladder with the reinforcing wires uppermost (if not uppermost, turn ladder over) as near as possible to its required position and anchors it by 'footing'. Rescuers 2 and 3, working on their respective sides, raise the ladder from the underneath side to the vertical position, assisted by Rescuer 1.

Rescuers 2 and 3 face the ladder, each 'footing' it, then Rescuer 1, pulling on the hauling ropes, extends the ladder to the required height ensuring that the latching device is properly engaged on the rung. The ladder is then laid back by Rescuer 1, who walks backward until the top of the ladder comes to rest where required, that is against sill, wall etc.

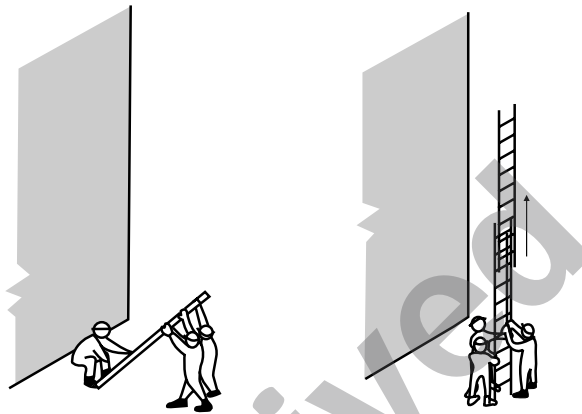

Figure 6:4

Erecting and extending a ladder—three rescuers

6.5.3 Erecting and Extending the Ladder (Two Rescuers)

When a third person is not available to foot the ladder, place the foot of the ladder against a wall, kerb or some other fixed object. Two rescuers under-run the ladder in the usual manner, extend it to the required height, and draw the foot of the ladder outwards to the correct distance from the wall.

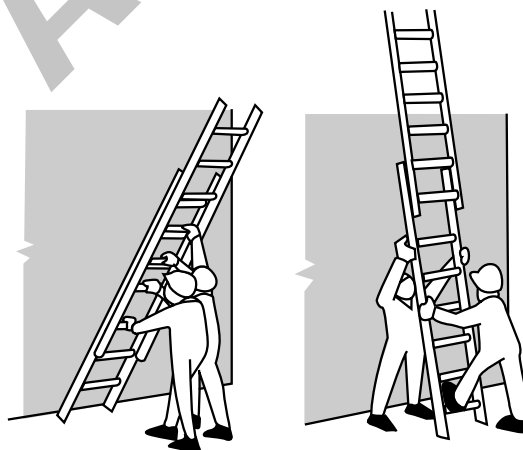

Figure 6:5

Erecting and extending a ladder—two rescuers

6.5.4 Angle of Ladders when Raised

When a ladder is raised, place the bottom of the ladder at a distance from the base of the structure equal to one quarter of the effective height.

6.5.5 Overlaps

Always extend normal two-part extension ladders with sufficient overlap for safety. For small ladders, an overlap of three rungs is recommended. A five-rung overlap is recommended for large ladders.

Wherever possible, erect the ladder so that the head of the ladder projects or overlaps the window, roof or other landing point by at least 1 m.

6.5.6 Securing the Head of the Ladder

When it is necessary to secure the head of a ladder, apply a lashing to any secure point, for example a length of timber long enough to spread across the inside width of a window (see Figure 6:6).

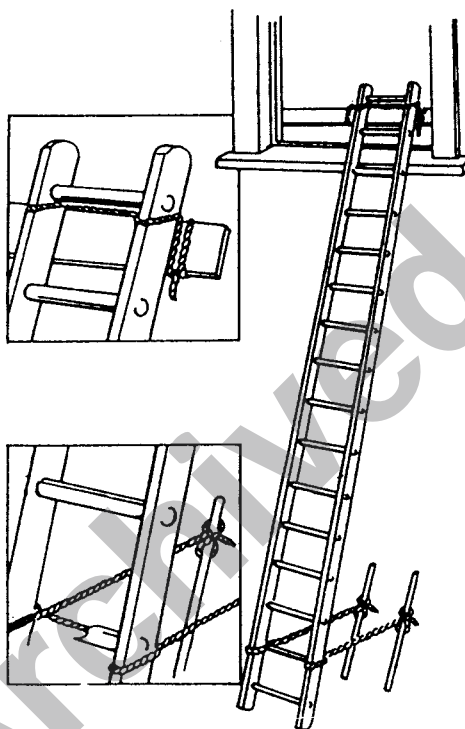

Figure 6:6
Securing a ladder

6.5.7 Securing the Foot of the Ladder

As shown in Figure 6:6, secure the foot of the ladder by fastening to a picket or tying back to any secure object behind the ladder, for example railings, fence posts etc.

6.5.8 Ladder Climbing

Climb the ladder steadily, keeping the body erect, the head upright, arms straight but not tense, without any tendency to hug the ladder, and hands grasping the rungs at a level between the wrist and shoulders. Remember that the legs, not the hands, carry the weight of the body when climbing. Generally, it is safer to use the instep rather than the ball of the foot on the rungs. When climbing a ladder, the arms and legs should work in unison, as shown in Figure 6:7.

WARNING
SECURE OR STABILISE LADDERS BY 'FOOTING' AT ALL TIMES WHILE RESCUERS ARE CLIMBING.

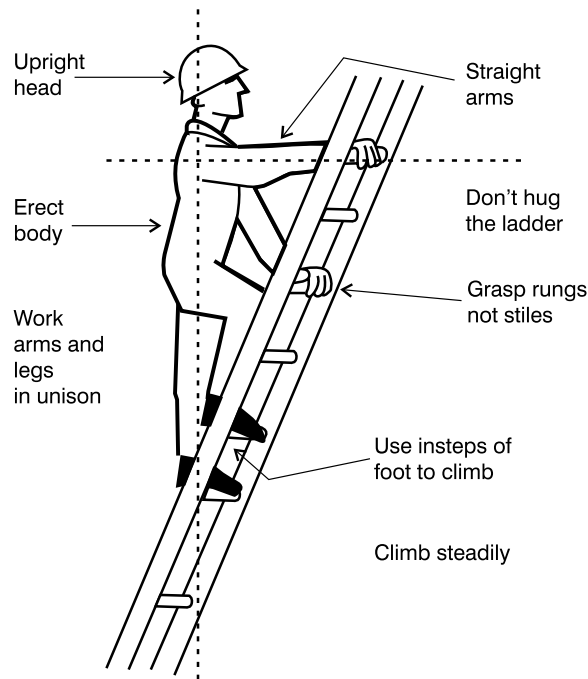

Figure 6:7
Correct ladder-climbing technique

When working at height on a ladder, secure the rescuer to the ladder or safety line by means of a lashing, sling, stop or harness. Consistent with occupational health and safety requirements, a fall-prevention system must be used—refer to State or organisational SOP.

6.5.9 Halving Ladders

In some cases, it may be necessary to have two short ladders when only one long extension ladder is available.

Halve the extension ladder for this purpose. That is, remove the sliding extension from the main ladder. First, place the ladder on the ground, the sliding section uppermost. Uncouple the ropes from the pulley and hooks or cleats, free the latching device and withdraw the upper extension. To reassemble, reverse the procedure.

Note: some extension ladders cannot be halved.

6.6 Maintenance and Testing

Regularly and carefully check extension ladders for damage or defects in accordance with the relevant Australian Standards. Pay particular attention to those ladders that are stored on vehicle roof racks and thereby exposed to the weather regularly.

Visually inspect the ladder for cracks in the timber, the security of the rungs and reinforcing wires, and for general appearance. Fibreglass ladders need to be checked for splintering and sun or ultraviolet damage. Metal ladders need to be inspected for burrs created by abrasion against other materials.

Check pulleys, latching devices and extension guides for lubrication and security, and lubricate the latching device pivot points and pulleys as necessary. Check and replace hauling ropes as necessary.

Never paint ladders, as the paint can cover quite serious cracks and defects. It is better to leave timber ladders in a natural condition and regularly oil with linseed oil, which will keep the ladder flexible and prevent water damage or rot.

CHAPTER 7

CASUALTY HANDLING

7.1 Introduction

Rescues will be conducted under almost every conceivable adverse condition. The method used for casualty removal will depend on the location of the casualty and the type of injury sustained. In some rescue operations, casualties will have to be lowered from the upper floors of buildings. In others, hoisted from below through holes in floors, or removed by a combination of those techniques. When casualties are handled by rescue personnel, take care to ensure that further aggravation of injuries does not occur.

Be aware that the safety of the casualty is paramount, even when immediate evacuation from a hazardous environment is necessary.

Make a careful assessment of the casualty's injuries, condition and possible entrapment and make a final check to ensure that the casualty is actually ready to move and is not caught or entangled in an unseen object.

WARNING

THE IMPORTANCE OF FIRST-AID TRAINING CANNOT BE OVERSTATED. ALL RESCUERS MUST BE TRAINED TO A REASONABLE QUALIFICATION LEVEL OF FIRST AID AND LIFE SUPPORT IN ORDER TO BE ABLE TO HANDLE CASUALTIES SAFELY AND EFFECTIVELY.

After removal, many casualties will have to be carried over piles of debris and uneven ground before being handed over to the ambulance service or first-aid station. Speed of removal is important, but it must be consistent with safety and proper handling to prevent further injury.

The method used will depend on the immediate situation, the condition of casualties, types of injury and available equipment. Rescue leaders should conduct frequent exercises in the removal of casualties, using live people as casualties to give team members understanding and confidence in the various methods, enabling them to make decisions promptly in times of emergency. As important as learning the methods, rescuers should experience the physical effort required in transporting casualties, either by stretchers or by some improvised method. The transportation of casualties over long distances is a very tiring task and requires fit personnel.

7.2 Triage

Where multiple casualties need attention, select casualties for treatment and rescue by order of priority. This selection or sorting of casualties is known as triage.

Rescuers may be called upon to perform the triage role at a rescue site as a specific task, or this may form one part of the overall reconnaissance element of a rescue.

While moving fairly quickly from casualty to casualty, the rescuer performing triage must:

- a. Quickly assess the condition of each casualty.
- b. Place any unconscious person in a lateral position—care for airway, breathing and circulation.

- c. Temporarily control serious bleeding—by use of bystanders or other rescuers as necessary.
- d. Choose the casualties with the greatest needs and the greatest chances of survival.

Note: it will sometimes be necessary to treat and rescue casualties of relatively low priority in order to access or to clear the way for treatment of high-priority casualties. Additionally, adopt the principle of 'remove the casualty from the risk or remove the risk from the casualty' where a site hazard presents a risk to casualties being treated prior to rescue.

Further and more detailed information on triage can be obtained from the Australian Emergency Manual Disaster Medicine, and from local medical, ambulance and first-aid services. The principle of triage is common to all States and Territories, but triage tags are not uniform and local information is essential.

7.3 Classification of Casualties

As a result of triage, casualties are broadly classified into four groups:

- a. **Priority 1: Severely injured**—in need of urgent medical care, urgent resuscitation and transportation required (red tag).

Severely injured casualties will require airway, breathing and circulatory support and as such will normally require constant management and supervision by a competent person. Rescuers should follow the danger, response, airway, breathing, chest compression and defibrillation (DRABCD) action plan (*refer to the Australian Resuscitation Council guidelines*) until relieved by a health professional.

- b. **Priority 2: Significantly injured**—condition stable and treatment can wait, or patient is unlikely to live and extensive medical care will jeopardise the survival of other casualties (yellow or orange tag). Casualties with significant injuries will need medical intervention and hospitalisation. However, their condition is such that they will survive if treatment is delayed. These casualties can usually be managed by a health professional managing a small group of casualties.

- c. **Minor injuries: Casualty ambulant** (walking wounded)—hospital admission unlikely (uninjured psychologically disturbed people included in this category) (green tag).

This group is often referred to as walking wounded but do not allow the casualty to walk if, for example, the casualty:

- is exhibiting signs of shock
- has the slightest risk of internal injuries
- has the slightest risk of spinal injuries
- has bled or is bleeding from an artery, even a small wound, and
- has head wounds, even though they may appear to be slight.

- d. **Deceased**—medical officer is required to certify death on card. Body becomes the responsibility of police/coroner's office (black tag).

These casualties should not be moved unless it is necessary to access live casualties.

- e. In some States, an additional classification is used for casualties with severe injuries and a poor prognosis.

WARNING
SERIOUS INJURIES WILL NOT ALWAYS PROVIDE HIGHLY VISIBLE SIGNS. CARRY OUT CAREFUL CASUALTY CHECKS. THE IMPORTANCE OF FIRST-AID TRAINING CANNOT BE OVER-EMPHASISED.

7.4 Stretchers

The three categories of stretcher in most common use are:

- a. the folding or pole stretcher (Figure 7:1)
- b. the basket stretcher (Figure 7:2), and
- c. the 'wrap-around' stretcher (Figure 7:3).

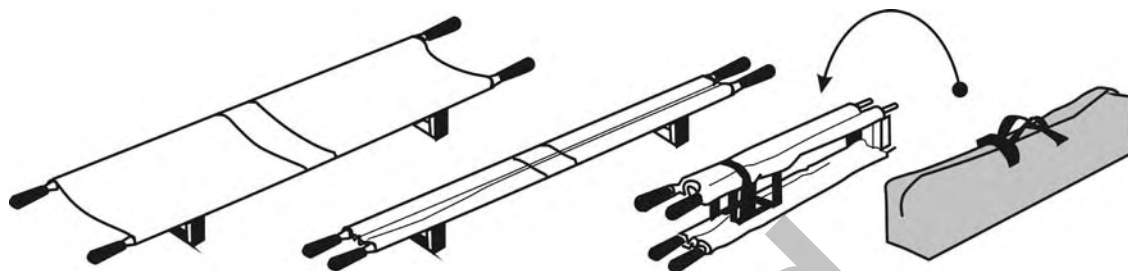

Figure 7:1
Folding stretcher

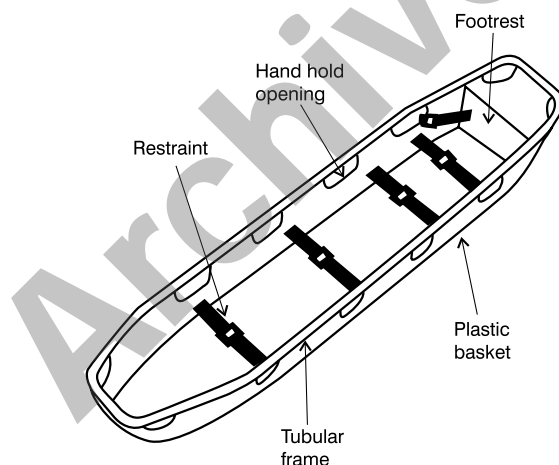

Figure 7:2
Basket stretcher

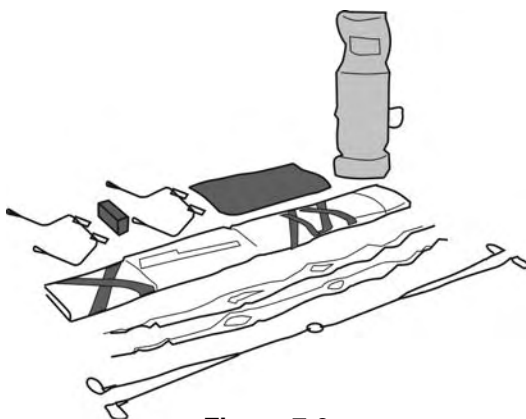

Figure 7:3
'Wrap-around' stretcher (Paraguard)

7.4.1 Advantages and Disadvantages

The significant advantages and disadvantages of the three categories of stretcher are shown in Table 7:1

Stretcher	Advantages	Disadvantages
a. Folding	<ul style="list-style-type: none">• low cost• easy storage• light and easily portable	<ul style="list-style-type: none">• lack of rigidity• poor spinal immobilisation• possibility of collapse during operations• difficulty in securing casualty
b. Basket	<ul style="list-style-type: none">• strength and rigidity• ease of handling and rope attachment• ease of securing casualty	<ul style="list-style-type: none">• awkward in confined spaces
c. Wrap-around	<ul style="list-style-type: none">• conforms with body• ideal for confined spaces• ease of securing casualty	<ul style="list-style-type: none">• some styles do not provide full spinal immobilisation

Table 7:1
Advantages and disadvantages of stretchers

7.5 Folding or Pole Stretchers

Set up the folding stretcher as follows before transferring a casualty to it:

- Unfasten the straps that hold the stretcher closed (if fitted).
- Spread open the stretcher and lock the spreaders in place by pushing on each bar with your foot, until it locks into place. Do not use your hands as they can be pinched by the hinges.
- Where it is possible that the centre hinge of the spreader bar may snag, causing the hinge to unlock and collapse the stretcher, use a securing rope. Tie a short length of rope from one stretcher handle to the centre hinge and then to the other stretcher handle in a 'V' pattern. The Clove Hitch is ideal for all three knots of this rig.

7.5.1 Blanketing the Stretcher

Before a casualty is placed on a stretcher, cover it with a blanket so that no contact is made with the canvas bed portion. This adds to comfort, keeps the casualty warm and, to a large degree, helps immobilise any fractures that may have been sustained. Use one or two blankets depending on the weather and on the supply of available blankets. In very warm weather, use a cotton bed sheet or sheets instead of blankets.

7.5.2 Double-blanket Method

- Lay one blanket lengthways across the stretcher, level with the head end, with about one quarter of the blanket on one side of the stretcher and one half on the other (Figure 7:4).
- Place a second blanket with its centre in the middle of the stretcher and its head about 400 mm from the top. Then fold the sides into the centre and out at the foot.
- Place the casualty on the stretcher with the head level with the top of the canvas.

- d. Commence blanketing by taking the centre of the second blanket in between the ankles of the casualty (to prevent chafing) and crossing the end points of this blanket over the legs and tucking them in. Take these points up between the knees if possible to prevent chafing.
- e. Take the short side of the first blanket over the body of the casualty and, if possible, tuck in.
- f. As the final operation, tuck the long side of the first blanket on the opposite side of the stretcher.
- g. In steps (e) and (f), fold the tips of the blanket in so as not to obscure the casualty's face. If operating in a wet or contaminated area, concertina the ends of the first blanket down the sides of the stretcher before placing the second blanket in position. This keeps it clear of the ground and it can be easily pulled out when required.

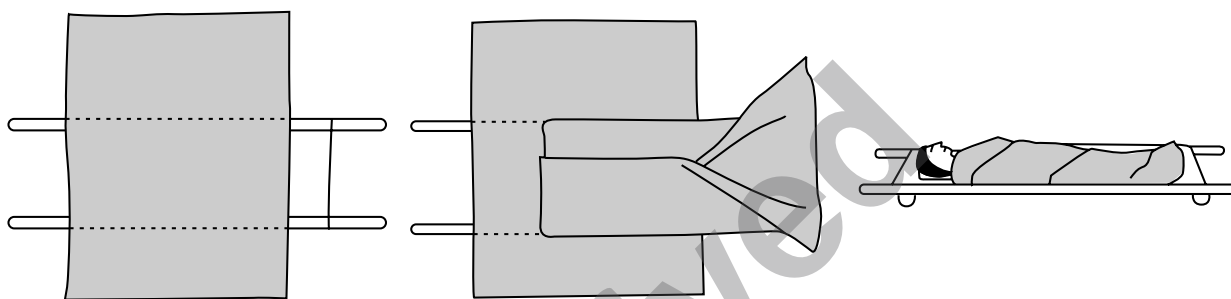

Figure 7:4

Double-blanket method

7.5.3 Single-blanket Method

Lay one open blanket diagonally down the stretcher, with the corner of the blanket in the centre of the top of the stretcher and about 150 mm overlapping.

Place the casualty on the blanket with the head level with the top.

Fold over and tuck in the lower half of the blanket. Do likewise with the top half.

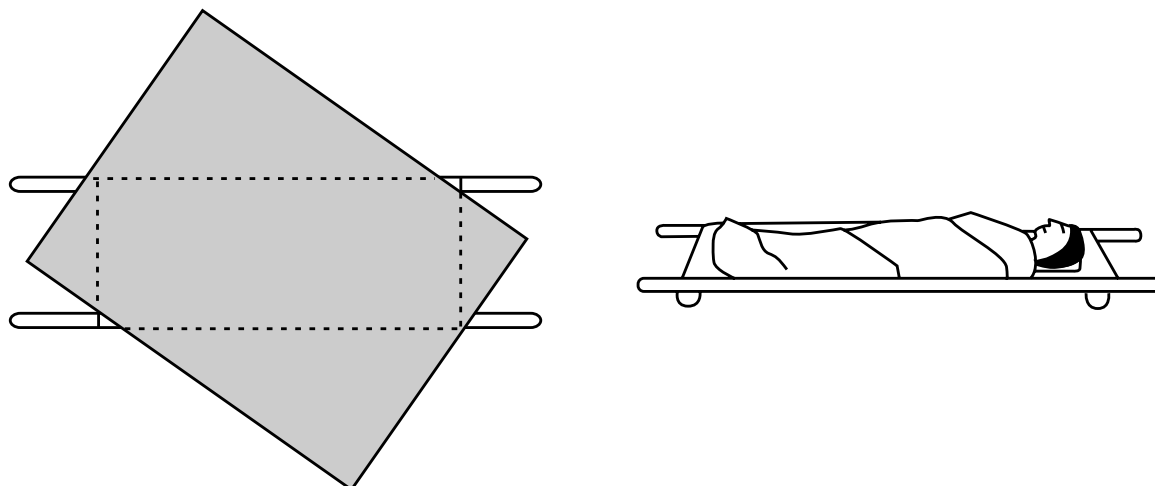

Figure 7:5

Single-blanket method

7.5.4 Improved Blanketing

Use a small tarpaulin as an alternative method to provide wrap-around protection when no blankets are available:

- a. Lay the tarpaulin on the stretcher with about 1 m overlapping the head end of the stretcher.
- b. Fold the head end in 200 mm folds to form a headrest.
- c. Fold the bottom of the covering over the casualty's feet.
- d. Fold one side of the tarpaulin over the casualty, and fold and tuck in the excess.
- e. Repeat the above procedure with the other side.

7.5.5 Lashing the Patient to the Stretcher

In many cases, casualties will have to be firmly secured to the stretcher to enable it to be handled in difficult places. No hard or fast rule can be laid down as to when a casualty should or should not be lashed in; however, the nature of the rescue should provide the answer. **If in doubt, lash the casualty in.**

The ideal size and length of rope for stretcher lashing is 12 m of 11 mm or 12 mm rope.

- a. To commence the stretcher lashing, form a Figure of Eight loop around one of the top stretcher handles and through the 'D'. From this point take three Half-hitches around both the casualty and the stretcher, the first in the region of the chest, the second in the vicinity of the wrists and the third hitch just above the knees (Figure 7:6).
- b. Take a Round Turn around the feet and apply three Half-hitches to those already formed on the opposite side of the casualty's body. Finish the lashing with a Round Turn and Two Half-hitches on the remaining top stretcher handle.
- c. Vary the position of the three securing Half-hitches according to the location of the injuries that the casualty has sustained. In the case of a female casualty, place the top securing hitch just below the breast line.
- d. Place bricks or timber under the stretcher 'Ds', before lashing commences, to enable the rope to be passed under the stretcher more easily.

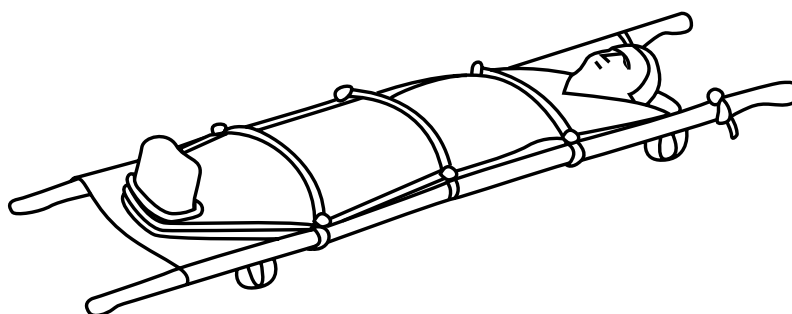

Figure 7:6

Basic stretcher lashing

7.5.6 Stretcher Lashing—Lateral Position

If it is necessary to transport a casualty in the lateral position on a stretcher, the method of blanketing and lashing will differ to the previous method.

7.5.7 Blanketing—Lateral Position

In addition to warmth, comfort and immobilisation, use the blanket for padding to keep the patient in the required lateral position. The following is the recommended method:

- Roll a blanket end to end and position it on the stretcher as in Figure 7:7. The rolled portion is used to pad the patient's back.
- Place a second blanket on the stretcher in a similar manner, with the rolled portion on the opposite side and the blanket folded over the patient and tucked under the first roll as in Figure 7:8.

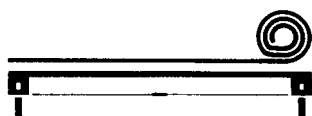

Figure 7:7

Lateral position blanketing

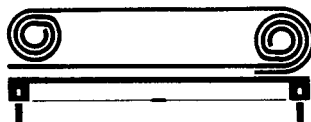

Figure 7:8

Lateral position blanketing

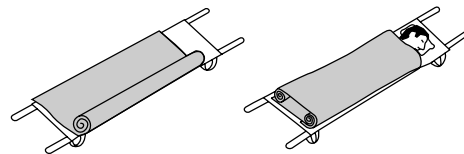

Figure 7:9

Lateral position blanketing with patient

7.5.8 Lashing—Lateral Position

The lashing of the stretcher differs from the normal method in that the rope does not pass around the feet. Pass the rope through the 'Ds' of the foot of the stretcher.

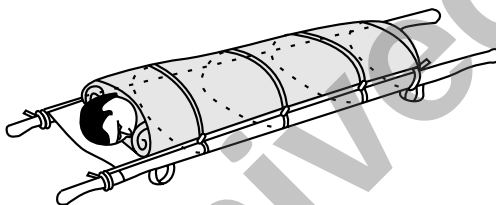

Figure 7:10

Lateral position lashing

7.6 Basket Stretchers

Two types of basket stretcher are currently in use. The older type has a strong tubular aluminium frame covered with 'chicken wire'. The newer type has a formed plastic, fibreglass or aluminium basket attached to a tubular aluminium frame. The newer designs have an advantage in that they are less likely to be snagged or penetrated than the wire model.

Other than the very old wire designs, these stretchers can accommodate a 'scoop' style stretcher or spinal board, which makes the transfer of a spinal casualty easier.

7.6.1 Blanketing a Basket Stretcher

Blanket a basket stretcher, particularly in cold weather, to ensure the maintenance of body heat, particularly during lengthy rescue or transfer operations.

- Lay an unfolded blanket over the stretcher, with the upper edge of the blanket just beyond the head end of the basket. Use two blankets if necessary.
- Place the casualty in the basket.
- If spinal injuries are not involved, place padding under the head for comfort.
- Fold the end of the blanket over the feet and tuck between the ankles to prevent chafing.
- Fold over, first one side, then the other, and tuck the blanket in.

- f. An alternative is to transfer the casualty inside a sleeping bag in the stretcher (where attention to injuries does not preclude this method), or to lay folded blankets under the casualty for insulation.

Note: Most 'wrap-around' style stretchers such as the Paraguard stretcher will fit inside most basket stretchers for ease of ground-level transportation.

7.6.2 Securing a Basket Stretcher with Securing Straps

Some basket stretchers are supplied with securing straps, with seatbelt buckles or Fastex clips, and the preparation of an adult casualty for horizontal rescue involves little more than tightening the straps. When the patient is small, there will be gaps between the patient and the sides of the stretcher. It is not improbable that a casualty could slide out from under the straps if the stretcher is tilted.

Gaps between the casualty and the stretcher sides may be filled with blankets, clothing or pillows etc before the straps are snapped in place. Remember that the purpose of strapping or lashing is to combine the patient and the stretcher in a solid manageable unit capable of being carried over hazardous terrain.

WARNING
WHERE STRETCHER STRAPS ARE FITTED WITH AUTOMOBILE-TYPE SEATBELT BUCKLES, TURN THE BUCKLES UPSIDE DOWN TO REDUCE THE RISK OF ACCIDENTAL RELEASE OF THE BUCKLES. USE A ROPE LASHING SYSTEM AT ALL TIMES, OTHER THAN WHEN THE STRETCHER IS MOVED OVER SMOOTH AND FLAT GROUND.

7.6.3 Securing a Basket Stretcher by Lashing

Lash the casualty securely to a basket stretcher with a 12 m length of 11 mm rope, or tape, with the lashing pattern dictated by the casualty's injuries and size, and by the attitude through which the stretcher will move. Optional lashing patterns are shown in Figure 7:11.

If the basket stretcher has no leg divider, secure the casualty's feet. If the casualty is to be shifted in a vertical position, secure the head of the patient. Pack soft material on either side of the casualty's head and tie a length of bandage to one lower rail, lay it over the casualty's head (not covering the eyes) and tie the other end to the opposite lower rail.

It is important to continually reassure any casualty who is secured to a stretcher in such a confining manner.

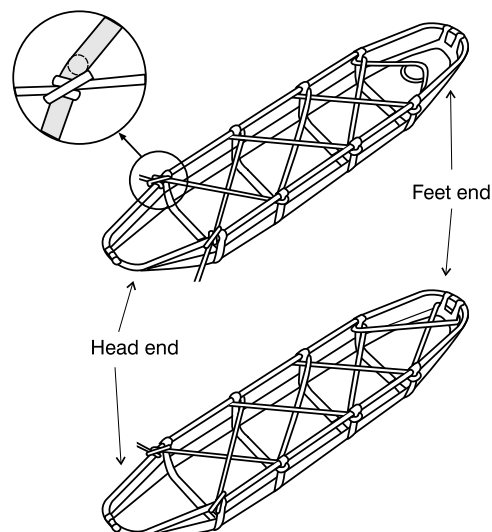

Figure 7:11
Lashing a basket stretcher

7.7 Wrap-around Stretchers

Wrap-around style stretchers such as the Paraguard (Figure 7:3), Sked (Figure 7:12) and the Fallright Evacuation Splint, while quite different in design and construction, share the same critical feature. They conform very closely to the casualty's body, thus adding very little width or bulk for confined space operations.

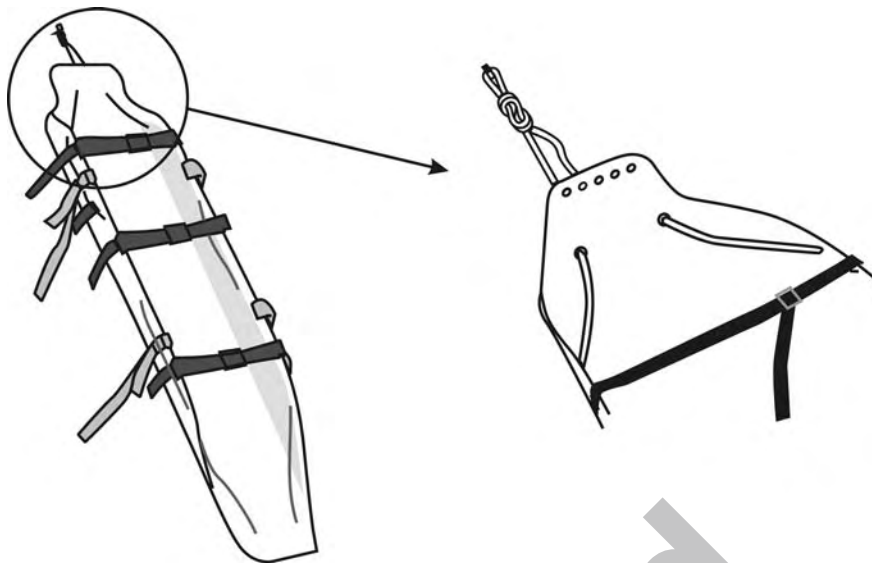
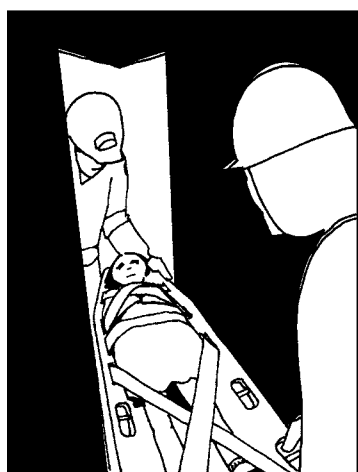

Figure 7:12
Sked stretcher

Each of the wrap-around style stretchers has advantages and disadvantages, which must be weighed up prior to use. Each has its own individual casualty securing system and method of attaching lowering and guide ropes. Comply with the manufacturers' recommendations in all respects.

7.8 Extrication Devices and Backboards (Spineboards)

Extrication devices and backboards facilitate the removal of casualties from situations while assisting to maintain spinal alignment. Backboards provide a firm supportive surface and, along with securing the casualty with straps and head restraints, provide a safe method of moving casualties with suspected spinal damage when used correctly. Extrication devices are used in conjunction with backboards and stretchers and are not patient transport devices. Extrication devices, when applied correctly, provide a higher level of spinal support.



(a) Backboard in use

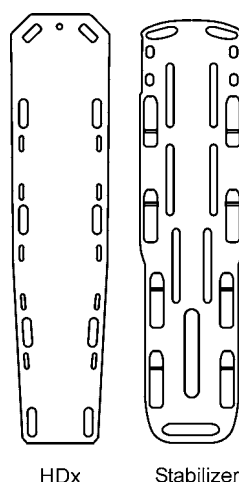

(b) Backboard/spineboard

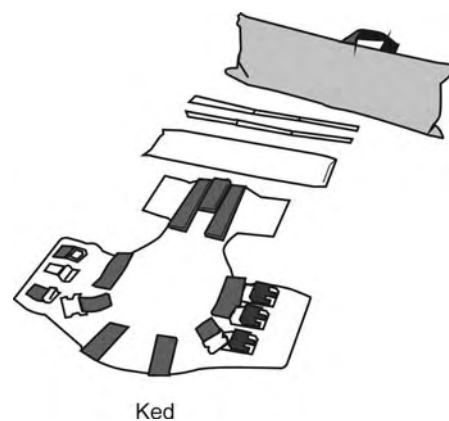

(c) Extrication device (Ferno KED)

Figure 7:13
Extrication devices and backboards

7.9 Improved Stretchers

In any disaster, there may be insufficient stretchers immediately to hand for the number of casualties involved. Such situations will normally be multi-agency responses, and the resources of all involved agencies should be brought to bear on the problem.

There are many methods of improvisation. Use some imagination when confronted with the problem, however, a number of the more obvious methods are described here.

7.9.1 Platform Stretchers

Improvised platform stretchers can readily be devised from doors, sheets of galvanised iron or bed-frames as shown in Figure 7:14 and 7:15.

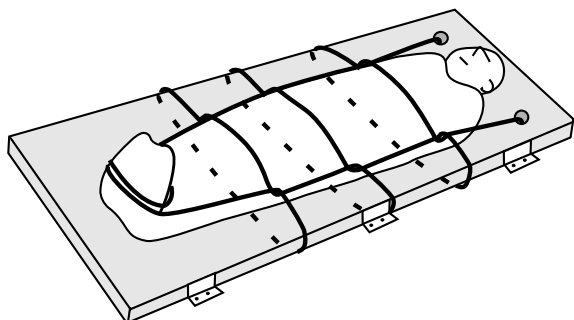

Figure 7:14
Door stretcher

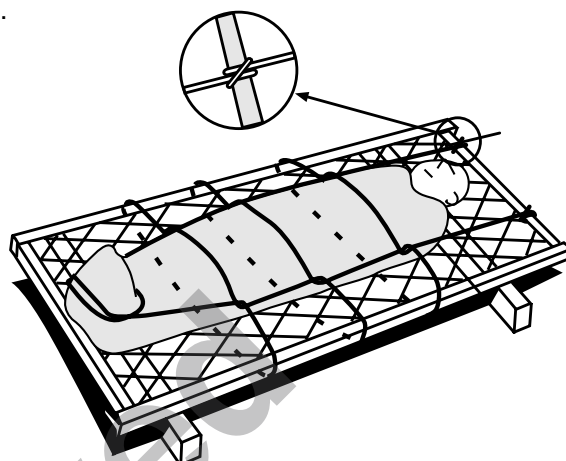

Figure 7:15
Bed-frame stretcher

7.9.2 Pole Stretchers

Pole stretchers are very simple to make and require two poles about 2 m long. Stout broom handles, water pipe or 50 mm x 25 mm timber are quite appropriate for this job.

Lay the poles parallel on the ground and about 600 mm apart. Form the bed of the stretcher with a blanket, sacks, overalls or coats as shown in Figure 7:16.

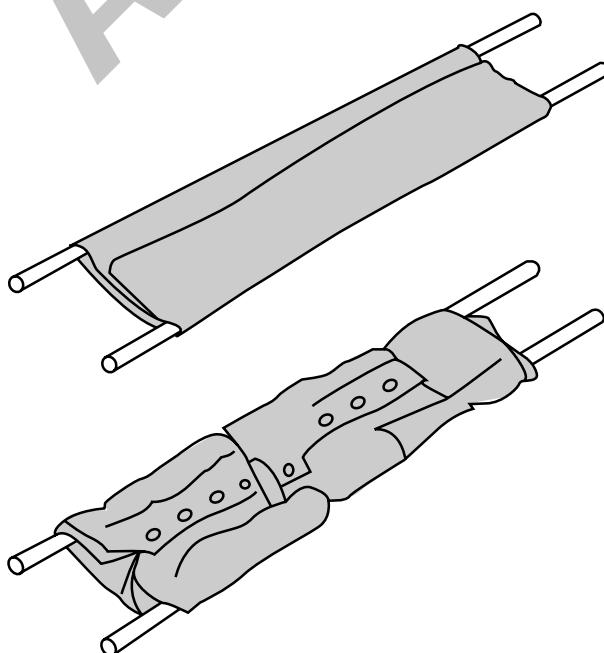

Figure 7:16
Improvised stretchers

7.9.3 Bush Stretchers

A bush stretcher can readily be devised from two timbers about 4 m to 5 m long, strutted and lashed together as shown in Figure 7:17. This is not a makeshift stretcher by any means, and in bush country may be the only suitable means of carrying an injured casualty over long distances.

With the casualty supported on the rope lashings, up to eight rescuers can carry the stretcher at shoulder height over rough ground and bush, thus avoiding many of the obstacles normally in the way of conventional stretchers.

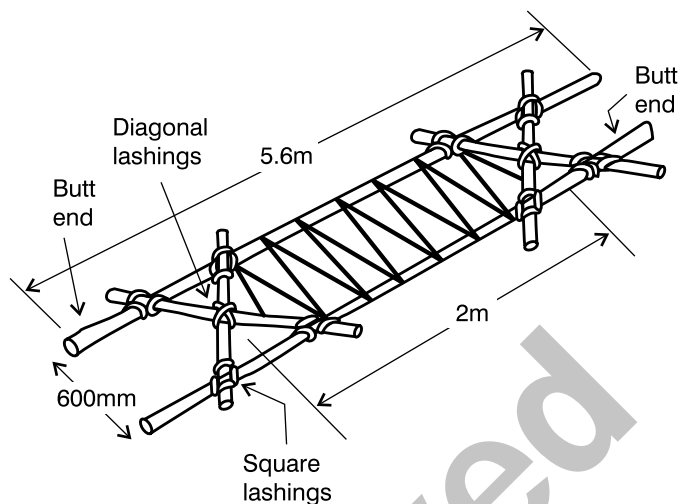

Figure 7:17
Bush stretcher

7.9.4 Ladders

Where for any reason a very narrow stretcher is required, such as for passing through small window openings, tunnels etc, a small ladder or one half of a small extension ladder can be used to advantage.

Place a decking of boards on the ladder (if available) and then blanket in the normal way. Figure 7:18 shows a variation to the standard stretcher lashing. Begin with a Clove Hitch on the stile above the rung nearest the casualty's feet. Then take two loose Round Turns around the ladder and Half-hitch the lashing to the centre of the turns. From here, take three Half-hitches around the body in the usual positions. Tie off the lashing with a Clove Hitch to a rung above the casualty's head.

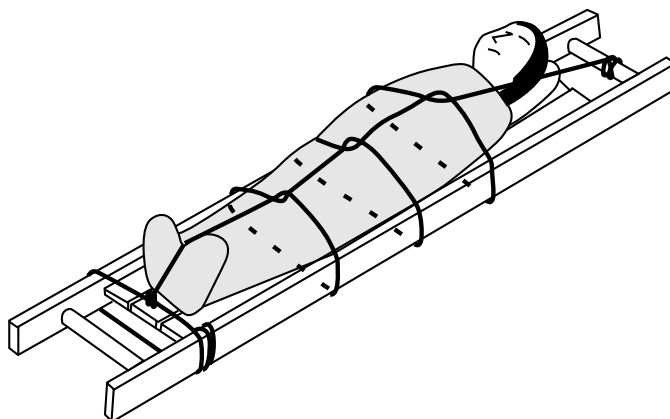

Figure 7:18
Ladder stretcher

7.9.5 Chairs

A strong kitchen-style chair can be used to carry casualties without serious injuries as shown in Figure 7:19.



Figure 7:19
Chair stretcher

7.10 Loading a Stretcher

Loading a stretcher is an important part of casualty handling. Correct methods are essential for the well being of the casualty to prevent aggravation of injuries. Make final checks by hand to ensure that a casualty is actually free to lift before a lift is executed.

7.10.1 The Four-rescuer Method

When using four rescuers to load a stretcher and where spinal injuries are not suspected, use the following method:

- a. Make ready the stretcher and place near the casualty's head or feet.
- b. The leader details three others to kneel down on one knee, on one side of the casualty (casualty lying flat on back). They all have the knee up closest to the casualty's head (Figure 7:20a).
- c. The leader kneels near the casualty's hip on the opposite side to the three others and eases the casualty on to one side.
- d. The other three place their hands and arms underneath the casualty and the leader lowers the casualty onto their arms.
- e. The leader gives the order '**Prepare to lift**' and, if no one dissents, follows it with the order '**Lift**', whereupon the other three, assisted by the leader, lift the casualty up.
- f. If necessary, the casualty can be briefly supported on the rescuers' knees (Figure 7:20b). The leader then places the stretcher under the casualty.
- g. Final orders are given: '**Prepare to lower**', followed by '**Lower**'.
- h. The three rescuers, assisted by the leader, lower the casualty on to the stretcher (Figure 7:20c).

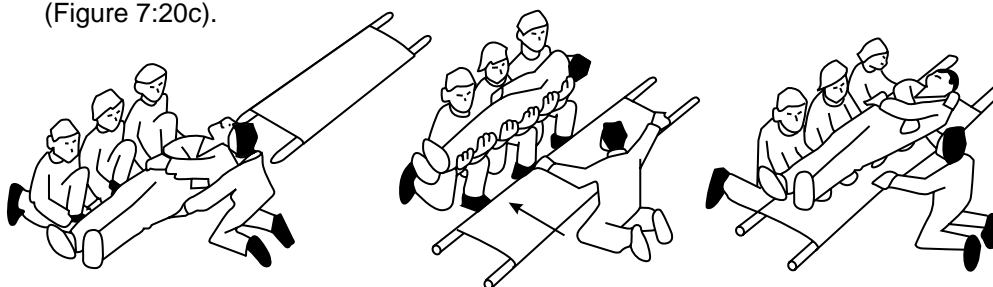

Figure 7:20
Four-rescuer lift

WARNING
DURING A FOUR-RESCUER LIFT, SUPPORT THE CASUALTY'S HEAD AND NECK AT ALL TIMES. IF SPINAL INJURIES ARE SUSPECTED, AN EXTRA PERSON IS REQUIRED TO PROVIDE CERVICAL SPINE STABILISATION.

7.10.2 Blanket Lift (Four or Six Rescuers)

The blanket lift is an effective method to load or move a casualty in a confined space:

- a. Make a stretcher ready using one blanket only.
- b. Roll a blanket lengthwise for half of its width and lay the rolled section along the side of the casualty (casualty flat on back).
- c. The leader then directs two (or three) rescuers to kneel down on each side of the casualty. The rescuers on one side ease the casualty over and the rolled section of the blanket is pushed well underneath the casualty.
- d. With the rolled up section of the blanket now under the centre of the casualty, ease the casualty over in the opposite direction and unroll the blanket. The casualty should now be lying flat on two thicknesses of blanket.
- e. Roll the sides of the blanket up close to the casualty's body to provide handgrips for the bearers (Figure 7:21).
- f. On the order from the leader, lift the casualty waist high and carry to the stretcher.
- g. On the order from the leader, lower the casualty onto the stretcher.
- h. Complete the blanketing with one blanket, leaving the lifting blanket in position.
- i. This 'blanket carry' can also be used as an improvised stretcher for carries over moderate distances.

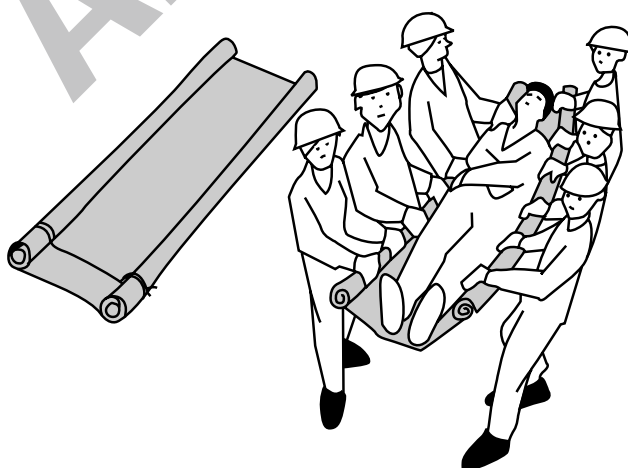

Figure 7:21
The blanket lift

WARNING
SUSPECTED SPINAL-INJURED CASUALTIES CAN BE SAFELY TRANSPORTED BY THIS METHOD WITH CORRECT IMMOBILISATION OF THE SPINE AND WITH PARTICULAR ATTENTION PAID TO THE HEAD AND NECK.

7.10.3 Log Roll and Scoop onto Backboard

The leader directs two (or three) rescuers to kneel down on each side of the casualty. The rescuers on one side ease the casualty over (maintaining spinal alignment) and the backboard is pushed up against the casualty.

With the backboard against the back of the casualty, ease the casualty over in the opposite direction and onto the backboard. The casualty should now be lying flat on the backboard.

7.10.4 Clothing Lift (Three Rescuers)

This is an emergency method that can be used when the casualty's injuries are not too severe and time is critical:

- a. Blanket a stretcher and place it close to the side of the casualty.
- b. Tie the casualty's hands together with a triangular bandage or similar material if unconscious.
- c. Roll the casualty's clothes together along the centre of the body.
- d. Three rescuers take up position on the opposite side of the casualty to the stretcher and position their hands as illustrated in Figure 7:22.
- e. The normal commands are given ('Prepare to lift' etc), then place the casualty gently on the stretcher.

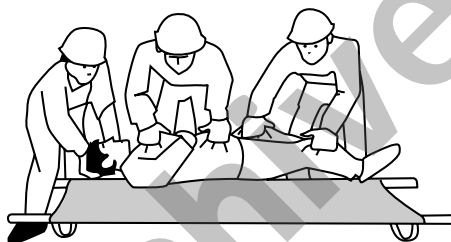

Figure 7:22
The clothing lift

7.10.5 Webbing Bands (Five Rescuers)

In some cases, it may be necessary to transport a casualty some distance to a place where a stretcher can be loaded. Webbing bands can greatly assist this operation. There are many configurations which can be used, one of which is illustrated in Figure 7:24.

Place the bands in position by pushing the long steel handle under the natural body hollows and see-sawing the bands into the required position, that is, under the buttocks and shoulders (Figure 7:23).

After bands are correctly positioned, centre the handles of each band above the middle of the casualty. The five rescuers take up position.

Any kind of improvised lifting bands can be used, for example 50 mm flat tape, wide sturdy belts, fire hose etc.

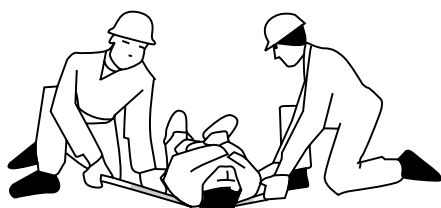

Figure 7:23
Placing webbing bands



Figure 7:24
Webbing band lift/carry

7.10.6 Specialist Lifting/Loading Devices

Specialist lifting/loading/extrication devices such as timber or synthetic spinal boards, Jordan Frames, scoop stretchers and spinal immobilisation devices or harnesses are readily available from rescue equipment suppliers.

Always use these devices in compliance with manufacturers' specifications and recommendations, and follow appropriate specialist training.

7.11 Moving Stretchers

7.11.1 Moving a Stretcher over Uneven Ground

Moving stretchers across a collapse site is difficult and potentially hazardous to the rescuers carrying the stretcher and the victim being transported in the stretcher. Carry a stretcher, wherever possible, in the horizontal position or slightly 'head high'. When moving over heavy debris or uneven ground this may prove to be difficult. Reduce risks to both casualty and rescuers to a minimum by adopting safety procedures:

- a. Use a team member to 'scout' in front of the carrying team to select the easiest route, identify any hazards and inform the team.
- b. Ensure there are sufficient stretcher handlers (a minimum of six is preferred if possible) and use the 'pass on' technique, where only the stretcher moves while the stretcher handlers remain stationary. Each handler establishes a strong footing position. The rear two handlers drop off the back of the stretcher and move to the front, and the stretcher is passed along before the process is repeated. Stretcher handlers must at all times endeavour to keep the head end of the stretcher tilted upward and to keep the victim's head above his/her feet. Where steep inclines or declines are encountered, use ladders and/or other platforms, materials and ropes to negotiate them.

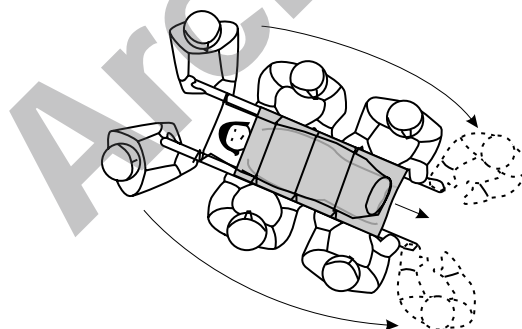

Figure 7:25

Stretcher passing—six rescuers

7.11.2 Moving a Stretcher in Confined Spaces

In confined spaces, if there is sufficient height and the casualty has been lashed to the stretcher, the stretcher may be stood on end and moved around sharp corners. Where the height is insufficient to permit this method, compromise between the vertical and horizontal positions. Carry the casualty feet-first as far as the middle of the right-angle bend. Place the foot of the stretcher on the ground and lift the head end as high as the situation will permit. Work the stretcher around the bend: one rescuer eases the foot end and the other the head. Under these conditions, do not tip the stretcher on its side. To do so increases its height and difficulty in handling.

It should be obvious that 'wrap-around' style stretchers are specifically designed for confined spaces. Use these wherever possible.

7.11.3 Passing a Stretcher over a Gap

Overcome a large gap that has to be negotiated by laying an extension ladder across it. Be mindful of ladder load ratings and, if possible, place a decking of boards over the rungs. Shorter gaps, such as in floors etc, can be patched using timber from the site or possibly the short ladder. Still smaller gaps can be traversed in a similar way to that described for moving over debris.

7.12 Rescue Techniques using no Equipment

This subject is covered under two headings:

- a. One-rescuer handling techniques.
- b. Two-rescuer handling techniques.

Clearly understand that the following techniques are for use in an emergency and that seriously injured casualties should, where possible, be placed on a stretcher.

Conditions such as fire or imminent danger of building collapse may, however, dictate that removal from the scene is the first priority. In some cases, this may even take precedence over life-sustaining first aid.

7.13 One-Rescuer Handling Techniques

7.13.1 Single-Rescuer Human Crutch

For this method to work, the casualty must be conscious and capable of giving the rescuer some assistance. Figure 7:26 clearly indicates how to affect the single-rescuer human crutch. Note the position of the rescuer's hands, one holding the casualty's wrists and the other taking a firm grip of the clothes at the waist on the far side of the body. The injured side of the casualty should be closest to the rescuer.

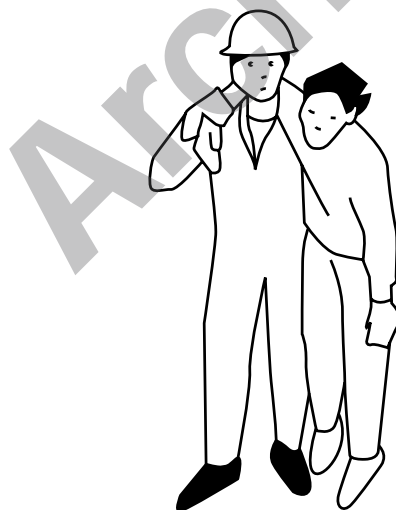

Figure 7:26
Single-rescuer human crutch

WARNING
ALL SINGLE-RESCUER TECHNIQUES INVOLVE THE RISK OF INJURY TO THE RESCUER.

7.13.2 Pick-a-back

This is an effective method when conducted correctly and the casualty is lighter than the rescuer. When the casualty has been loaded (must be conscious), take care to ensure the casualty is supported well up on the rescuer's hips, with the body literally draped across the rescuer's back.

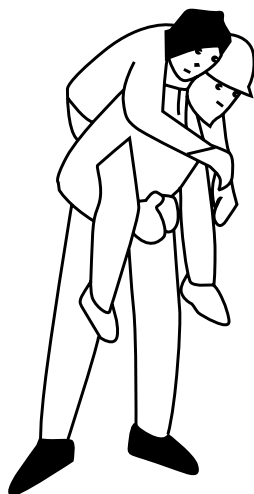

Figure 7:27
Pick-a-back carry

WARNING
THE RESCUER AFFECTING A PICK-A-BACK CARRY RUNS A SIGNIFICANT RISK OF BACK INJURY AND MUST TAKE APPROPRIATE SAFETY PRECAUTIONS.

7.13.3 Firefighter's Crawl

This is an invaluable method where a casualty has to be removed from a burning or smoke-filled building. As shown in Figure 7:28, both rescuer and casualty have their heads low down where the clearest and coolest air is to be found if the building is on fire. It is also clear that the entire weight of the casualty does not have to be supported by the rescuer.

Cross the casualty's hands and tie with a bandage or similar. Vary the firefighter's crawl method according to personal preference. Probably the most effective method is for the rescuer to place an arm, shoulder and head through the casualty's arms as shown.

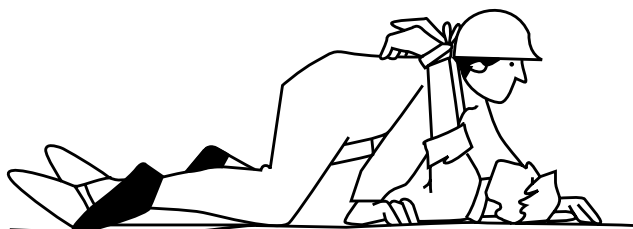

Figure 7:28
Firefighter's crawl

7.13.4 Removal Down Stairs Method

This method is used to recover a heavy casualty down stairs, when the rescuer cannot use the pick-a-back or other methods. However, its use need not be restricted to staircases.

With the casualty lying flat, first tie the wrists together using a triangular bandage or similar. Next, come to the head and lift the casualty into the sitting position. Reach through under the casualty's arms and grasp the wrists. The rescuer is then in a position to drag the casualty backwards and, if a staircase has to be negotiated, a large measure of support can be given to the casualty's trunk by the rescuer using a knee to ease over each successive step. Remember that the strongest part of any staircase is close to the wall.

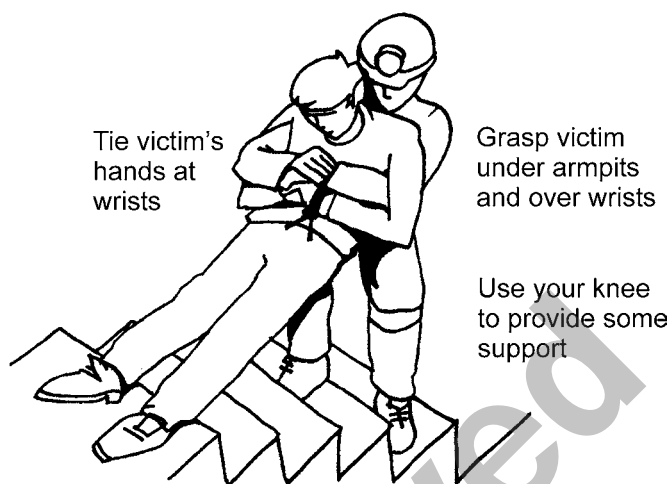

Figure 7:29
Removal down stairs

7.13.5 Helping a Casualty Down a Ladder

Take great care when helping a person down a ladder, even if that person is conscious and uninjured. Keep in mind that many people are unaccustomed to height and may 'freeze-up' or lose their hold.

- Take a position, one rung below the casualty, with arms encircling the casualty's body and grasping the rungs.
- Keep in step with the casualty, letting the casualty set the pace. Keep knees close together to ensure support in case the casualty loses hold or becomes unconscious.
- Talk to the casualty to help keep up morale and overcome fear.
- If the casualty becomes unconscious, let the casualty slip down until the crutch rests on the rescuer's knee. By repeating this procedure for each step down the ladder, the rescuer can lower the victim to the ground.

WARNING
THIS TECHNIQUE COULD EXCEED THE SAFE WORKING LOAD OF THE LADDER OR DESTABILISE THE LADDER LEADING TO RISK OF SERIOUS INJURY. A RISK ASSESSMENT MUST BE CARRIED OUT BEFORE ATTEMPTING THIS ACTIVITY.

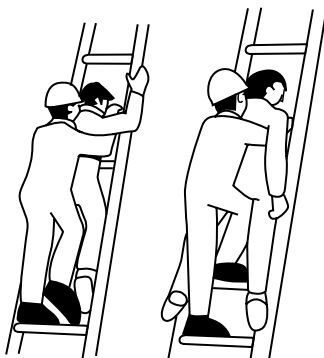

Figure 7:30

Helping a casualty down a ladder

7.14 Two-Rescuer Handling Techniques

7.14.1 Two-Rescuer Human Crutch

As can be seen from Figure 7:31, this method is similar to the single-rescuer human crutch, except that the casualty is supported on both sides with the arms of the rescuers crossed over on the casualty's back and grasping the clothing on the opposite sides of the body.

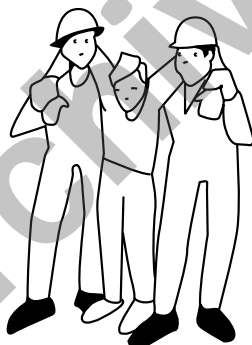

Figure 7:31

Two-rescuer human crutch

7.14.2 Two-Handed Seat

Rescuers kneel on either side of the casualty, get the casualty into a sitting position, place one arm under the knees and link up with the hand-to-wrist grip. They cross their free arms over the casualty's back, where they get a firm grip on the clothing (Figure 7:32).

The leader gives the normal orders for lifting and lowering.

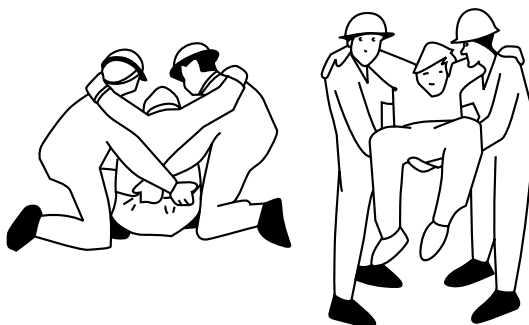

Figure 7:32

Two-handed seat

7.14.3 Three-Handed Seat

This method gives the casualty good support and is reasonably comfortable for the rescuers. It has the added advantage that the two-rescuer team has a spare hand for steadying.

One rescuer grasps their left wrist with their right hand and the second rescuer places their hand and wrist as shown in Figure 7:33a. This forms a seat. If the casualty is capable of standing for a short period, load the casualty by placing the seat under the buttocks. If not, the rescuers place their hands under the casualty's knees first and then join up. In either case, the result should be as in Figure 7:33b.

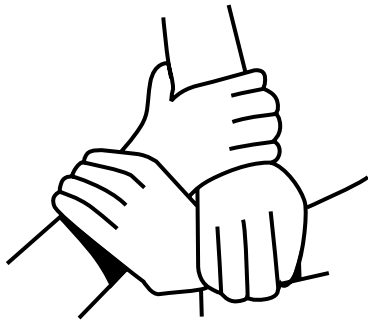

Figure 7:33a
Three-handed seat

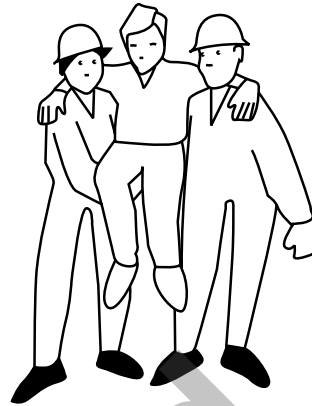

Figure 7:33b
Three-handed seat

7.14.4 Four-Handed Seat

This is a method where each rescuer grasps their left wrist and join hands as in Figure 7:34a. This provides a comfortable seat for the casualty and places a minimum strain on the rescuers. However, as can be seen in Figure 7:34b, the casualty must be sufficiently conscious to hold on.

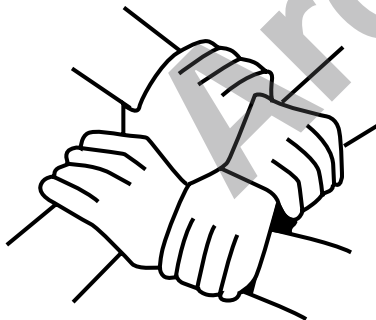

Figure 7:34a
Four-handed seat

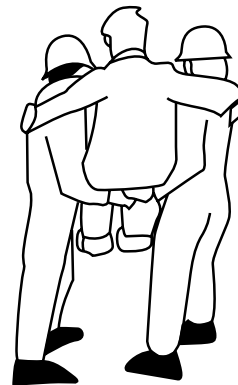

Figure 7:34b
Four-handed seat

7.14.5 The Fore and Aft Method

This is perhaps the most suitable way in which two rescuers can handle an unconscious casualty.

Prepare the casualty in the same way as for the removal down stairs method. That is, tie the wrists together. The first rescuer stoops at the rear of the casualty. Reaching under the casualty's arms, the first rescuer grips the casualty's wrists. The second rescuer stoops between the casualty's legs, grasping the casualty underneath the knees. Following the standard lift orders, lift the casualty to the carrying position (Figure 7:35a). If the casualty has a leg injury, minimise the effects of this by having the front rescuer cross the casualty's legs over and carry the casualty to one side as in Figure 7:35b.

The advantage of this method is that the rescuer supporting the casualty's feet has a free hand with which to open doors, clear debris etc.

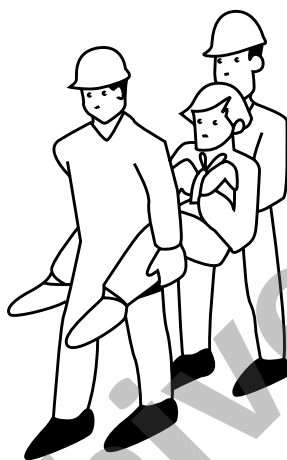

Figure 7:35a

Fore and aft lift/carry



Figure 7:35b

Fore and aft lift/carry

It is again stressed that the foregoing one and two-rescuer techniques are generally confined to emergencies where removal from the scene is the first priority.

Archived

CHAPTER 8

ANCHORS AND HOLDFASTS

8.1 Introduction

Anchors and holdfasts are used in rescue to secure a line, rope, wire or chain that will be under load. They will fall into three main classes:

- a. Natural—Trees and boulders.
- b. Constructed—Those that have to be set up (for example, by use of pickets and lashings, anchor devices or buried baulks of timber).
- c. Improvised—Those found on the site (for example, reinforced concrete or metal standards, metal framework of buildings, baulks of timber across door openings etc).

8.2 Natural Anchors

The most readily identifiable anchor points are trees and large rocks or spikes of rock. Select these carefully, with regard to load and direction of load. These points should not be too close to risk areas, and must be tested by a hauling crew before use.

8.3 Constructed Anchors

8.3.1 Picket Holdfasts

Pickets are suitable as anchors and are used as single pickets or, when formed into a holdfast, may be arranged as 1 and 1; 2 and 1; or 3, 2 and 1 systems, according to need. Observe the following points:

- a. Drive the pickets into the ground at about 90 degrees to the line of pull, at an approximate angle of 45 degrees from ground level, leaning away from the load, and with two-thirds of their length into the ground. The strongest picket should be nearest the load.
- b. Connect the pickets with lashings at 90 degrees to the pickets. The lashings should go from the head of the one in front to ground level on the one behind. This determines the distance between the pickets, which should never be less than 700 mm apart.
- c. Monitor anchor systems at all times.
- d. As a rough guide to safe working loads, a 1500 mm x 25 mm mild steel picket properly driven into ground with good holding qualities will safely support a load of approximately 350 kg.
- e. As the number of pickets in the holdfast increases, the load it will support increases by approximately 350 kg for each picket.

8.3.2 Placement of Pickets

Place pickets either using sledge hammers or impact drivers.

- a. Sledge hammers—Two rescuers position and hold the pickets. Each holds one end of a short cord taken around the picket in a Clove Hitch, while a third rescuer hammers the picket into the ground. Rescuers must wear safety glasses/goggles and leather gloves.
- b. Impact drivers—These are capped lengths of pipe with an internal diameter greater than the pickets. They are fitted with handles as shown in Figure 8:1. Use them in place of hammers to drive the picket by sliding impact.

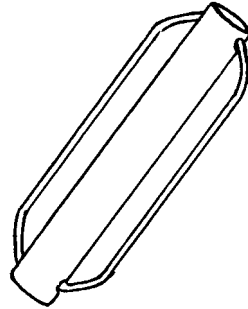

Figure 8:1
Impact driver

8.3.3 Picket Removal

Use a large Stillson or pipe wrench to simply remove pickets from almost all placements. Fit the wrench to the shaft of the picket and use it to wind the picket around and out of the ground by exerting an upward pressure on the wrench handle.

8.3.4 Picket Lashings

Use a 12 m rope to form each lashing. Start the lashing with a Clove Hitch about 180 mm from the head of the front picket. Take four turns around the base of the back picket and the head of the front picket, placing these above the Clove Hitch. Apply frapping turns around the lashing, finishing off with a Clove Hitch around the lashing, thus using up whatever spare rope is left. Tighten the lashing before commencing the frapping turns.

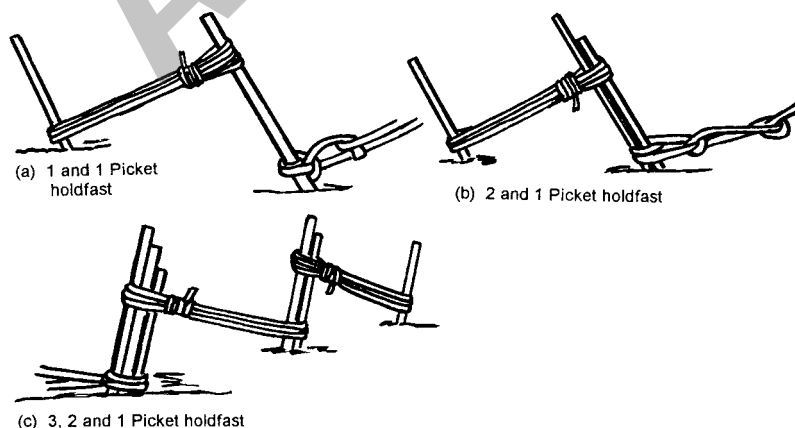

Figure 8:2
Picket holdfast systems

8.3.5 Anchor Plates

An anchor plate is a pierced heavy metal plate through which a number of short pickets or spikes can be hammered into the ground to secure it. Secure a shackle to one end for attachment purposes.

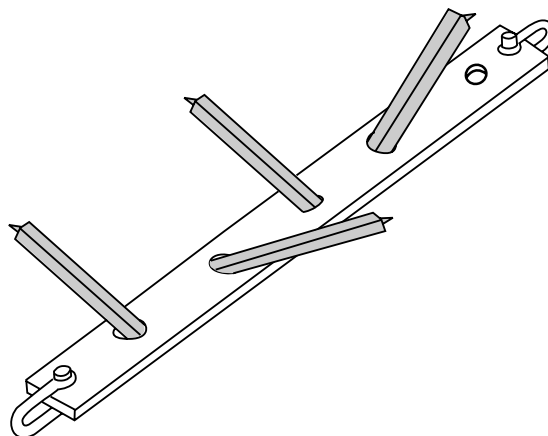

Figure 8:3
Anchor plate

8.3.6 Buried Holdfasts

A buried holdfast requires a stout piece of timber, a length of steel girder, a large diameter water pipe or a vehicle spare wheel. Dig a trench to accommodate the material used and a small outlet at right angles to the trench to allow the rope or wire to come to the surface. The greater the load to be applied, the deeper the trench should be. It must be appreciated that the buried holdfast is only satisfactory where the angle between ground level and the rope is small. This being the case, the trench need not be filled in, but detail a rescuer to check the holdfast when the initial load is applied.

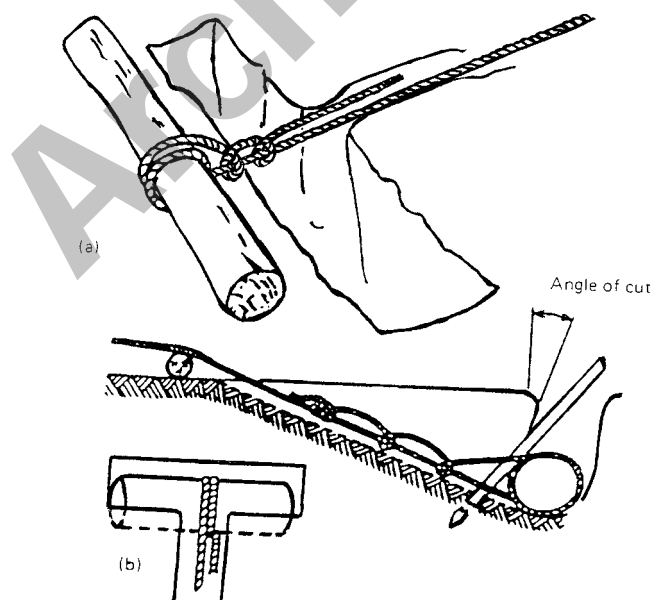

Figure 8:4
Buried holdfasts

Where a round section of material such as a log or pipe is used for the buried holdfast, the positioning of the rope is critical. Take the rope around the holdfast so that the standing part comes to the bottom of the holdfast and the running end comes to the top of the holdfast as shown in Figure 8:4(b). As the load is applied, this will tend to roll the holdfast down into the trench rather than upwards.

If a holdfast is required in soft sand, a wheel can be buried in much the same way as the above methods. A deep, angled slot is dug to accommodate the wheel at least 1 m below the surface and then a channel at right angles allows the cable or chain to pull at right angles to the wheel. The chain can be attached to the wheel by placing a picket or wheel brace behind the wheel, such that the chain goes through the hub opening of the wheel to the picket or wheel brace, as in Figure 8:5 below.

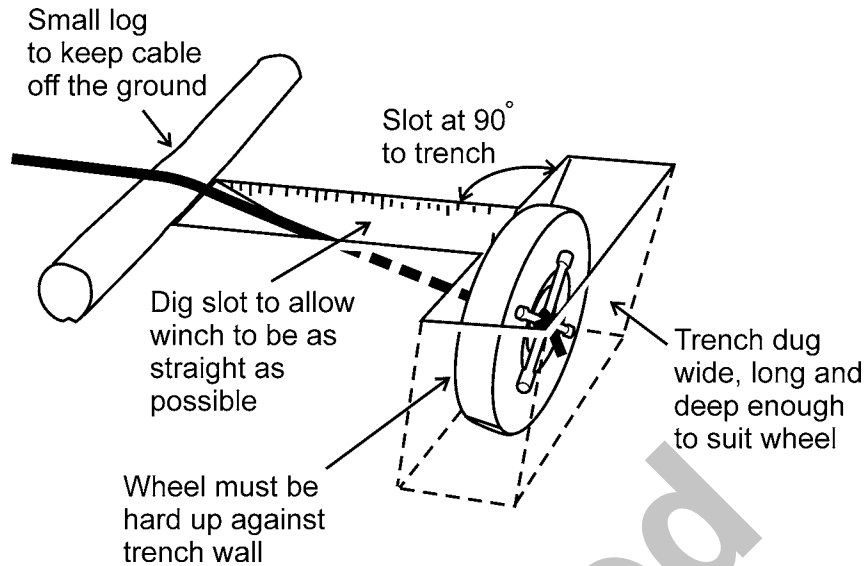

Figure 8:5
Buried wheel holdfast

8.3.7 Log and Picket Holdfast

Set up this heavy duty anchor as shown in Figure 8:6, with four pickets properly placed about 400–500 mm apart, and a second row of four pickets placed 1 m behind the first row. Lay a log, beam or other suitable section of material behind the first row of pickets and lash each pair of pickets together.

This method is of particular use in wet or soft earth, since the log acts as a beam and bears evenly against the front row of pickets.

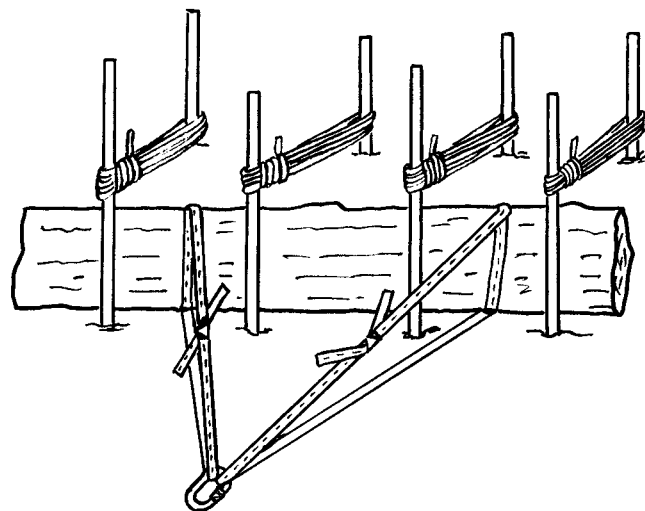

Figure 8:6
Log and picket holdfast

8.4 Sand Anchors

Marine sand anchors can also be used in desert or coastal dunes. There are a few varieties, but a common one is the Stingray sand anchor, which works as any sand anchor by burying itself as the load is applied (Figure 8:7).

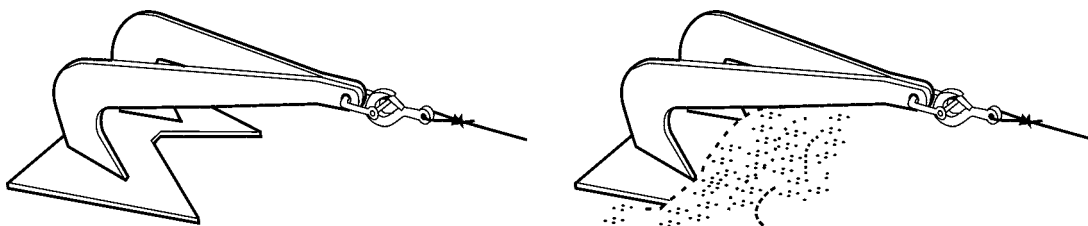

Figure 8:7
Sand anchors

8.5 Improved Anchors

When using an improvised holdfast (for example, an electric light pole, a baulk of timber across a doorway or a heavy vehicle), exercise care in assessing whether or not the item selected will in fact carry the load, and that it is correctly placed relative to the anticipated load.

Improved anchors can be constructed by placing a beam across a doorjamb, window corner or any part of the building that will allow a beam to be secured across a structure. Other anchors can be created by using part of the building superstructure such as patio posts, stairways, railing, brace and beams.

Since the strength of the above anchors cannot easily be calculated, consideration must be given to backups and planned redundancy.

8.6 Precautions in Operations

Observe the following points in anchorage operations:

- a. Place padding to protect anchors and slings.
- b. Ensure pickets are of sound materials, preferably steel, and are correctly placed and secured.
- c. Anchors must be assessed as capable of sustaining the maximum anticipated load in the appropriate load direction.
- d. Test a selected point in all appropriate load directions.
- e. Regularly check all anchor points, slings and attachments throughout the operation.

8.7 Selection of Anchors

Given the various types of anchors available, always make the selection of the most appropriate point or points on the basis of speed and simplicity.

As the first choice for anchorage, always select a large single point capable of sustaining the calculated maximum loading. Where no single point is sufficiently strong to sustain the load, bring two points together so that the load is evenly distributed between the two points as shown in Figure 8:8.

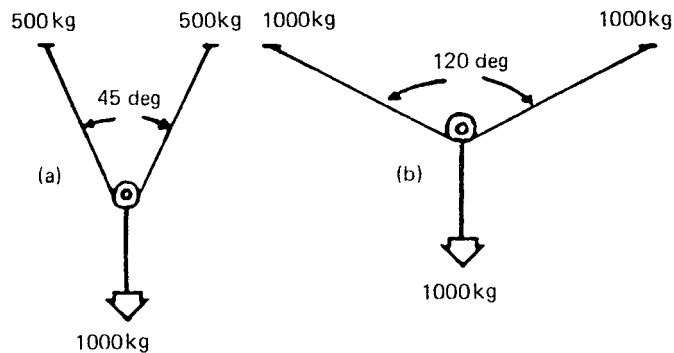

Figure 8:8
Anchor loading angles

8.8 Sling Loading Angles

When the two legs of a sling system form an angle of 120 degrees, each leg supports 100 per cent of the load. This is due to the fact that the legs start to pull against one another as the angle increases. Above 120 degrees, the tension begins to increase at an alarming rate. At 150 degrees, the load is 200 per cent of the original load on each leg.

Operationally, 90 degrees is a safe relationship between the two legs of the system, and the smaller the angle, the lower the load on each leg. At an angle close to zero, the load on each leg is around 50 per cent of the original load.

This principle for loading angles holds when using a two-leg sling to support a load or when securing a load to two separate anchor points. It is a direct relationship of load and angle of attachment.

WARNING
THE ANGLE AT WHICH ANCHOR SLINGS MEET MUST NEVER BE MORE THAN 120 DEGREES
AND SHOULD PREFERABLY BE LESS THAN 90 DEGREES.

8.9 Attachment to Anchors

Tie ropes off directly to anchors, providing that the anchor material is padded or will not damage the rope itself. Wherever possible, use two independent anchor points as the standard for any task, with the load equally shared between the points.

Rescue anchors are most commonly set up with the load attached by means of climbing tape slings and rescue-rated karabiners. In any single anchor point system, take two tape slings completely around the anchor, and clip all four loop ends into the karabiner. Where multiple point systems are set up, a single tape sling is acceptable for each point.

Set up heavy-duty anchor systems using steel wire rope, webbing or chain slings taken around a padded anchor and connected to the load by means of appropriately rated shackles.

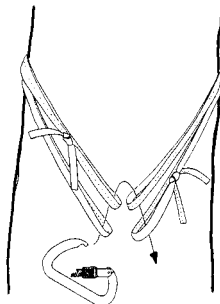

Figure 8:9
Karabiner and sling attachment to anchor point

8.10 Karabiners

Karabiners, known also as 'krabs', 'biners' or 'snaplinks', are the most common item of hardware used in vertical rescue. They are normally a 'D' or modified 'D'-shaped metal link, with a spring-loaded opening section (the gate) in one of the long sides. The gate allows ropes and slings to be clipped into the karabiner for attachment purposes.

Karabiners are manufactured from either high-tensile steel or alloy, and may have either a plain opening gate or one fitted with a screw-locking device, which prevents the gate from accidental opening. Consequently, karabiners are referred to as either **snaplinks** or **screwgates**.

Most manufacturers stamp the rated strength of the karabiner into the metal for easy reference. Rescue karabiners should be of **screwgate** pattern with a minimum rated strength of 2500 kg. **Snaplink style karabiners are not recommended for rescue.**

Take care not to drop these devices or knock them on hard surfaces, as they are made of specialised steel or alloys. Small stress points can be introduced into the metal, which may then cause deterioration of the device. Figure 8:10 shows the basic parts of a screwgate karabiner.

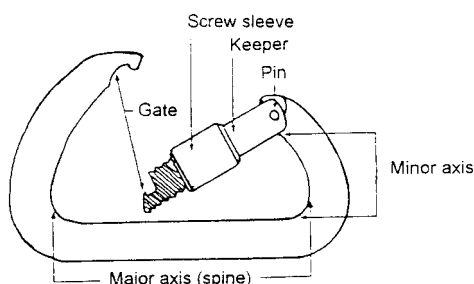

Figure 8:10
The rescue karabiner

8.10.1 Accidental Gate Opening

The main job of a karabiner is to maintain its link with the other elements of the rescue system. To do this, the karabiner gate must remain securely closed. If it does not, the connecting elements will come apart and the system will fail.

There are several ways in which karabiner gates may open accidentally. Among the most common situations are where:

- a. the karabiner is pressed against an edge or surface, forcing the gate open as shown in Figure 8:11, and
- b. a rope or section of tape is pulled across the karabiner gate, forcing it open (Figure 8:12).

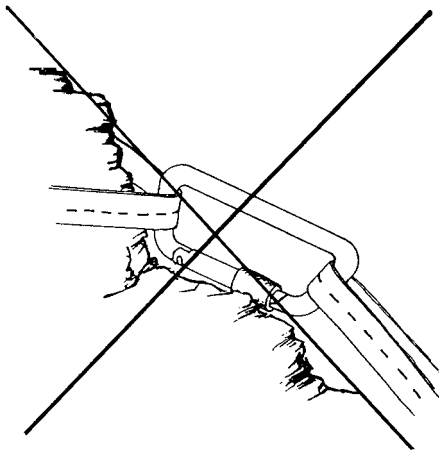

Figure 8:11
Unsafe karabiner loading

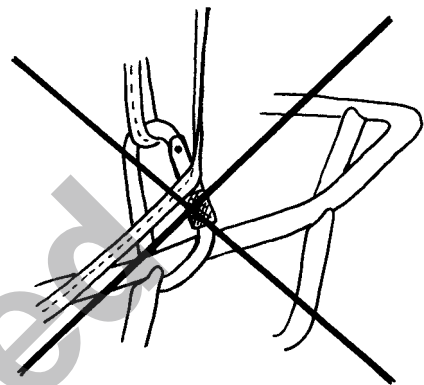

Figure 8:12
Unsafe karabiner loading

8.10.2 Concerns with Locking Karabiners

Withdraw from service any karabiner that regularly becomes unlocked without apparent reason. Karabiners are designed to be locked only to finger tightness. In their concern for safety, and in some anxiety, some people tend to over-tighten a karabiner gate and are then unable to unlock it. This most commonly occurs when the gate is tightened while the karabiner is under load. Subject it to a similar load again to readily unlock it.

8.10.3 Karabiner Usage

Karabiners are designed to be loaded along the major axis or spine as shown in Figure 8:10. As previously stated, the gate is the weakest point of a karabiner and any side loading places an unnatural force on the karabiner, severely reduces its strength, and may cause it to fail.

With some karabiner designs, vibration can cause the gate-locking sleeve to unscrew. Always use karabiners in a manner that will ensure that gravity will keep the sleeve in place.

Whatever the type of karabiner in use, it is the rescuer's responsibility to monitor it at all times to ensure that the gate remains closed.

WARNING

MAXIMUM STRENGTH IS ONLY ACHIEVED WHEN THE KARABINER GATE IS LOCKED. DO NOT USE KARABINERS UNLESS THE GATE IS PROPERLY CLOSED AND LOCKED.

8.11 Shackles

There are two principal types of shackle, 'D' and 'bow', with 'D' being the most commonly used in the rescue environment. Almost all are made from plain round steel bar and are secured by a round section steel pin. All should comply with AS 2741:2002.

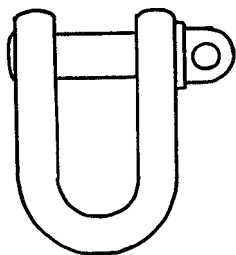

Figure 8:13
'D' shackle

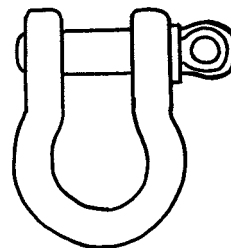

Figure 8:14
'Bow' shackle

The pin is located through one eye of the shackle and screws directly into the other (threaded) eye to secure the attachment in the shackle.

Select shackles that are large enough to accept the slings or other attachments, which comply with AS 2741:2002 and which are appropriately rated for the loading and task.

WARNING
USE ONLY THE SHACKLE PIN TO SECURE THE SHACKLE. THE PRACTICE OF REPLACING THE PROPER PIN WITH A NUT AND BOLT IS HIGHLY DANGEROUS AND MAY CAUSE THE FAILURE OF THE SHACKLE.

8.11.1 Safety in Operations

Note the following safety points:

- a. Remove from service and destroy any shackles or pins that are worn by more than 10 per cent of the original diameter.
- b. Do not use shackles or pins that have been bent, strained, deformed or damaged. Remove them from service and destroy.
- c. Properly tighten and either mouse or monitor screw shackle pins to ensure that the pins do not unscrew under load.
- d. Always use shackles of the correct size and shape for the task.

8.12 Safety Summary

The three-point safety plan recommended for all anchorage operations is as follows:

- 1—Select points that are suitable, strong and safe.
- 2—Ensure all connections are properly made and checked.
- 3—Monitor the anchor system at all times.

Archived

CHAPTER 9

PULLEY SYSTEMS AND WINCHES

9.1 Pulley Systems

Use pulley systems to gain a mechanical advantage in hauling, lifting and lowering operations.

A system is formed by the reeving of pulleys with rope. All rescuers should be thoroughly familiar with the correct terms, applications, capabilities and maintenance of this equipment.

The traditional forming of ropes and pulleys into block and tackle systems has largely been overtaken by the more modern Z-rig pulley techniques, which use kernmantel rescue ropes and lightweight high-strength rescue pulleys.

9.1.1 Terminology

The following terms and expressions are used in conjunction with pulley systems:

Becket	A loop or small pulley at the opposite end of the shell from the hook. Used for making fast the standing end of the tackle rope.
Chock-a-block	When two pulleys have been rounded in as far as they can possibly go, they are said to be 'chock-a-block'.
Eye pulley	A pulley fitted with a closed eye rather than a hook for attachment.
Fall	All of the parts of rope connecting the pulleys in a system.
Heave or haul	The act of pulling on the running end of the tackle rope to operate the tackle.
Mousing	Securing the hook of a pulley.
Overhauling the pulleys	The process of separating the pulleys in the system by a desired distance before attaching the running pulley to the load (at least the distance the load is to be moved).
Pulley	A sheave in a frame or shell, provided with a connection point by which it may be attached to another object.
Redirection pulley	A pulley used in a system to change the direction of the pull without affecting the mechanical advantage.
Reeving a tackle	The process of passing ropes over the sheaves of pulleys in the proper order to form a system.
Returns	The parts of the fall (ropes) between the pulleys.
Rounding in	Bringing the pulleys closer together.

Running end	The free end of the fall or rope to which the pulling power is applied.
Running pulley	The pulley attached to the object being moved.
Sheave	The grooved wheel over which the rope is run in a pulley.
Shell	The frame or part of the pulley that holds the sheave and to which the strap, hook or eye is attached.
Snatch block	A single sheave pulley with an opening or gate in one side of the shell, through which a rope can be engaged or 'snatched' into the sheave, without threading the end of the rope through. This opening is secured by means of a hinged or pivoted portion of the strap.
Standing end	The part of the fall or rope that is made fast to the becket of a pulley in a system.
Standing block	The system pulley, which is fastened to an anchor.
Strap or cheek	The side plate of the pulley to which the hook or eye is attached.
Swing cheek pulley	A pulley design in which the side plates or cheeks can be pivoted on the axle to open the pulley and permit access for the rope to the sheave.

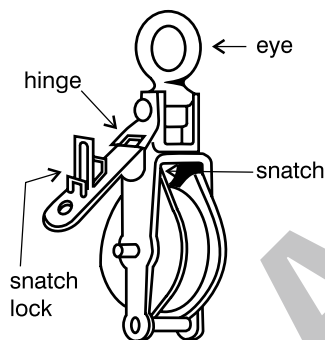

Figure 9:1
Snatch block

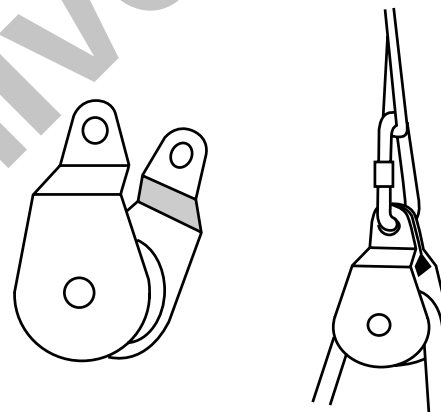

Figure 9:2
Swing cheek pulley

9.1.2 Types of Pulleys

The pulleys normally used in rescue systems are:

- a. single sheave pulleys
- b. double or two-sheave pulleys
- c. triple or three-sheave pulleys, and
- d. snatch blocks.

The size of a block is measured by sheave diameter (that is, the diameter of the sheave at the bottom of the rope groove).

Sheave size and shape are important to safety. The diameter of the sheave must be such that the rope is not turned too sharply or it will be damaged, and, particularly with steel wire rope (SWR), the shape of the sheave groove must be correct for the rope.

9.1.3 Characteristics of a Lightweight Rescue Pulley

Lightweight rescue pulleys should be of swing cheek design and have the following characteristics:

- The sheave should have a diameter at least four times the diameter of the rope.
- The cheek plates should be moveable so that the pulley can be placed on the rope at any point without having to feed the rope through. They should also extend beyond the edge of the sheave to protect the rope from abrasion.
- The axle should have rounded ends, which will not snag on ropes, other gear or objects.
- The bearings should be of such construction as to allow the sheave to turn freely when loaded.
- The rated strength should be in excess of 1500 kg, and preferably greater than 2500 kg.

9.1.4 Reeving a Pulley System

A modern lightweight Z-rig pulley system, such as the theoretical 3:1 rig shown in Figure 9:3, is best reeved in place. Bring the load line to the anchored pulley, through it and forward to the moving pulley, through the moving pulley and back to become the running end.

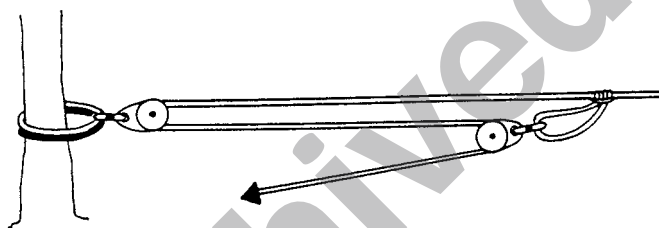

Figure 9:3
Theoretical 3:1 Z-rig

A safety brake should be used with all single-rope mechanical advantage systems, as a safety brake will catch the rescue load if the haul team lets go of the mechanical advantage system accidentally. A safety brake can be made using many devices, but the most common are the Prusik loop and ascender. Check with your relevant State and Territory emergency services for their equipment use.

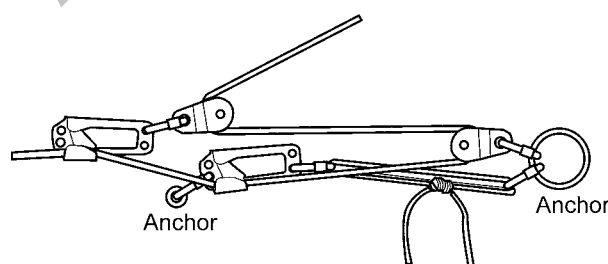

Figure 9:4
Z-rig with ascender

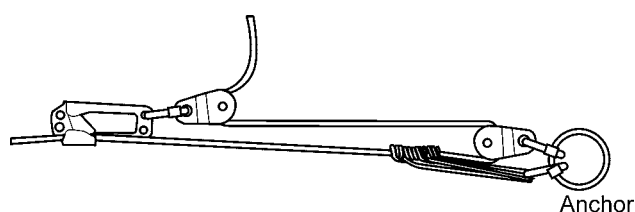

Figure 9:5
Z-rig with tandem Prusik loops

To reeve a system of large standard pulleys (Figure 9:6), two rescuers kneel (to avoid back strain) back-to-back and about 1200 mm apart. The rescuers each have a pulley just in front of them between their feet, with the hooks pointed away from them. The coil of system rope should be to the left of the top pulley when a lifting tackle is being reeved.

The first rescuer reeves the standing end of the rope through the lowest sheave of the top pulley then passes the rope to the second rescuer who reeves it through the lowest sheave of his or her pulley.

The rope is then passed successively through the sheaves of both pulleys from left to right and finally made fast to the becket. Secure the running end of the rope to prevent slipping.

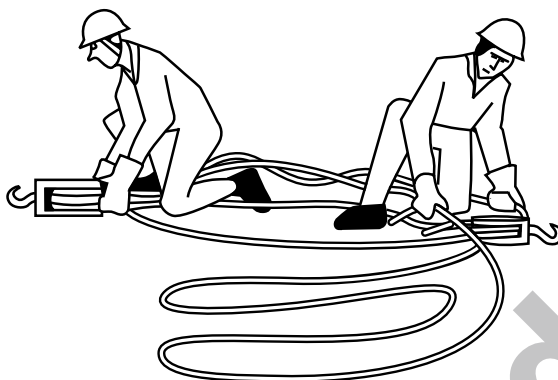

Figure 9:6
Reeving a standard pulley system

9.1.5 Types of Pulley Systems

A lifting system is one in which the load is attached to the running (lowest) pulley, and with the running end of the fall coming off the standing or upper pulley. When calculating the capability of a lifting system, realise that only the returns between the pulleys assist in the lift, and that the running end does not help the lift at all. Apply power to the running end and in the opposite direction to the direction in which the load is to be moved.

A hauling system is one in which the running end of the fall comes off the running pulley (to which the load is attached), and the standing pulley is made fast to an anchor of appropriate capability.

9.1.6 Mechanical Advantage

To calculate the Theoretical Mechanical Advantage (TMA) of a pulley system, count the number of sheaves or the number of returns in the system. For a system involving five sheaves, the TMA would be expressed as being 5 to 1 (or 5:1).

The Actual Mechanical Advantage (AMA) is less than the theoretical advantage due to the amount of friction caused by the ropes passing over the sheaves or contacting each other in the returns. The actual efficiency of the pulleys in the system is also taken into account.

The most effective way to reduce the friction in a mechanical advantage system is to build the simplest and most efficient haul system, with the greatest mechanical advantage using the least amount of pulleys with larger diameter sheaves.

As an example, a light gyn system has five sheaves and five returns, giving a TMA of 5:1. With this system, each kilogram of pull applied to the running end of the rope theoretically applies 5 kg of pull or lift to the load. In fact, the AMA is in the order of 3:1 due to the considerable reduction in efficiency caused by friction. For the purpose of calculation, the average hauling ability of each team member is 50 kg.

Figure 9:7 shows the traditional names by which standard pulley systems are known, along with the TMA and AMA for each rig.

a. Single tackle

TMA 1:1
AMA 0.9:1

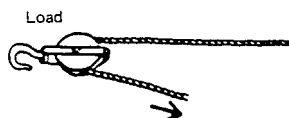

b. Single whip tackle

TMA 2:1
AMA 1.66:1



c. Luff tackle

TMA 3:1
AMA 2.33:1



d. Double luff or gun tackle

TMA 4:1
AMA 3:1



e. Light gyn tackle

TMA 5:1
AMA 3:1

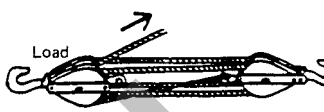

f. Heavy gyn tackle

TMA 6:1
AMA 3.5:1



Figure 9:7
TMA/AMA of traditional pulley systems

Note: Mechanical advantage systems above 4:1 must be used with caution and monitored regularly as they can overload a rescue system if there are too many haulers.

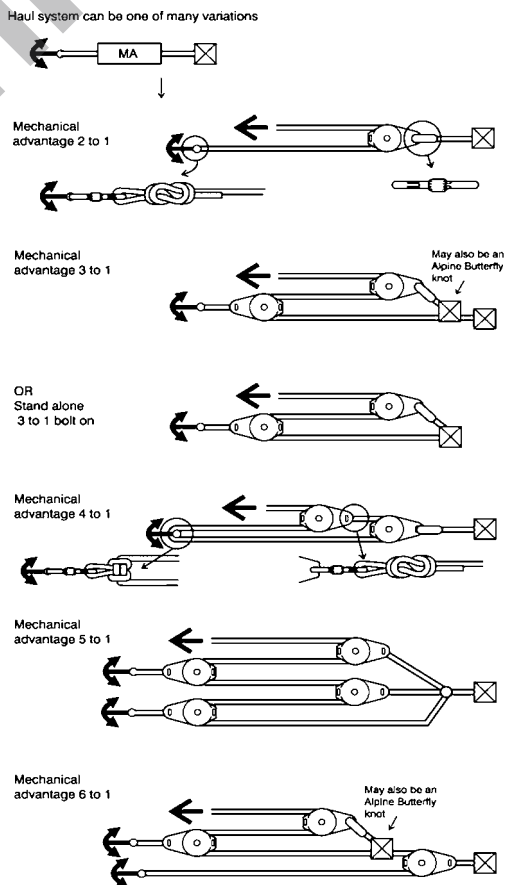

Figure 9:8
Lightweight pulley systems

9.1.7 Improved Hook Mousing

Wherever possible, fit pulley hooks with automatic mousing devices to prevent the load from jumping from the hook. Use the following improvised mousing technique in the event that a plain hook pulley must be used.

- a. Use the mousing twine on the bight for speed of application and strength.
- b. First, hitch the twine to the hook above the bulge of the shank so that it cannot be pulled downwards.
- c. Then lead it towards the bowl of the hook, being fixed to the shank again by one or more Half-hitches prior to the formation of the first figure of eight or diagonal lashing turns.
- d. Pass these around the hook on alternate sides of the sling eyes.
- e. Pass at least two Half-hitches around the diagonal turns and inside the eyes of the slings to prevent the bights of the diagonal turns from sliding over the bill of the hook (Figure 9:9).
- f. One of the easiest and simplest ways of mousing a hook quickly is to use cloth tape or insulation tape around the hook and shank (Figure 9:10).

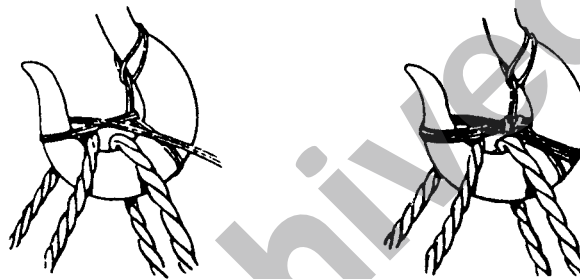

Figure 9:9
Standard mousing technique

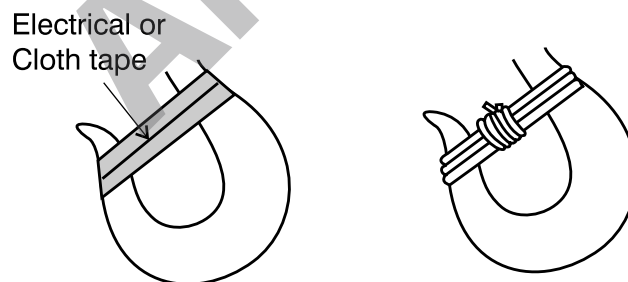

Figure 9:10
Electrical or cloth tape mousing method

9.1.8 Precautions in Operations

Observe the following safety factors when working with pulley systems:

- a. Ensure pulley sheave sizes are appropriate to the rope used.
- b. Ensure the fall is free from kinks and twists, and runs easily over the sheaves.
- c. Ensure all fastenings are securely made.
- d. Always carry pulley systems. Never drag them over the ground.

- e. Ensure all hooks are properly moused.
- f. Always ease off suspended weight gently. Never lower in jerks.
- g. Ensure that rescuers always haul or lower in unison, positioned on alternate sides of the running end of rope to keep the pull in a straight line using the hand-over-hand method.
- h. Do not touch the returns near the pulleys when they are moving, as the rescuer's hand may be trapped by the rope and drawn into the pulley.
- i. Never attach more than one tackle to either the load or anchor sling.
- j. Maintain pulleys well, handle carefully and keep free of dirt and grit, and ensure all working parts are sufficiently oiled to allow free movement.
- k. Use snatch blocks or single sheave blocks on the running end of the system as redirection pulleys wherever possible. This will change the direction of haul to the horizontal, so that the rescue crew can work to best advantage.
- l. When using snatch blocks, check safety pins are secured.
- m. Ensure all anchor points are capable of supporting the total load involved.

9.2 Lift/Lower Rope Rescue Devices

A number of pre-rigged lift/lower rescue devices are readily available on the commercial rescue market. These systems operate either as traditional pulley rigs or as friction drums or capstans. The devices are categorised as either pulley systems or drum systems.

9.2.1 Pulley Systems

These rigs are identical in design and operating principles to conventionally reeved pulleys, with the most common configuration being a 4:1 TMA 'gun tackle'. Several models are fitted with a rope brake cam in the shell of the anchored pulley, allowing for the final rope return to be secured between hauls. This cam can be 'tripped' by an accessory cord for lowering operations. Devices such as the Rescue Master operate on the same principle but use a special inertial brake pulley.

Systems such as the Haulsafe (Figure 9:11) and the Rescuemate use lightweight rescue pulleys, and can readily be reeved with a length of rope that is appropriate to the most common applications within the agency's area of operations. The entire kit can then be stored and carried in a rope pack ready for rapid deployment on all lift/lower/haul tasks.



Figure 9:11
Pulley system

9.2.2 Drum Systems

Drum-controlled systems such as the Griptech (Figure 9:12) and the Rollgliss provide friction for a controlled lower by means of the number of turns of rope formed around a rolling drum. They can be used with or without a travelling pulley, and in general provide a lower TMA for lifting/hauling than pulley systems.

While the Griptech has an optionally fitted fall arrest cam, drum systems generally rely on a rope brake (a mechanical rope ascender) for safety during lifts/hauls. This brake must be independently anchored by means of a strop, and fitted to the hauling part of rope. Unless this brake is secured in both directions, it must be re-set throughout a lift/haul operation, and must be manually 'tripped out' during a lower.



Figure 9:12
Drum system

9.2.3 Operational Usage—Standard Procedures

- a. Reeve the device with a length of rope sufficient for normal applications in the area of response. Take into account the rope required to form the returns required for the specific device.
- b. When used for life rescue purposes, rig the device with rope that complies with AS 4142.3:1993 (man-made fibre rope for static life rescue lines).
- c. Use the devices strictly in accordance with the manufacturers' guidelines.
- d. These systems can be anchored overhead for direct lift/lower operations, or can be used for horizontal hauling. When used horizontally, take additional care to ensure that the device is clear of all contact.
- e. Ensure safety brakes or cams are active or fitted for all lift/haul operations.
- f. Follow standard procedures with respect to anchoring, crew operations, commands and the wearing of gloves.

9.3 Tirfor Style Winch

The Tirfor style of winch consists of a machine or casing through which a long SWR passes and is attached to the load to be hauled or lifted. The operation of a lever handle backwards and forwards pulls the rope through the machine, which, if properly anchored, causes the load to be hauled towards the machine.

As a device for lifting or hauling, the machine has innumerable uses and applications. Being light and compact, it can be attached to any convenient holdfast or hung from overhead beams or girders, slung from or attached to derricks or 'A' frames, or even attached to the load itself if the rope end is anchored to an immovable object.

The rope enables the load to be lifted, lowered or hauled considerable distances without changing the position of the machine and, in conjunction with the SWR blocks, permits the most convenient position to be selected for fastening the machine. The rope can then be taken over the pulley, through window or door openings, or down through floors to wherever the load may be. It can also be passed over a block, at the head of a derrick or 'A' frame, to obtain height for raising loads.

WARNING
DO NOT STEP OVER OR STAND NEAR A WINCH ROPE THAT IS UNDER TENSION. THE BACKLASH FROM A BROKEN CABLE CAN BE FATAL. KEEP CLEAR OF LOADS BEING WINCHED.

9.3.1 The Tirfor Kit

The Tirfor winch kit consists of:

- a. a pulling and lifting winch unit complete with a swivel hook to enable it to be secured
- b. a detachable telescopic tubular steel handle for operating the unit, and
- c. a length of flexible SWR fitted with a hook at one end, the other end being tapered and fused. (This rope is coiled on to a reeler for convenience in carriage.)

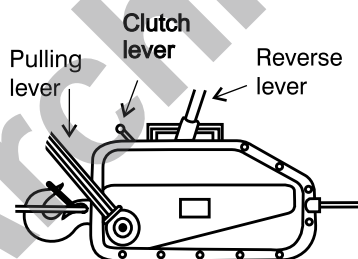

Figure 9:13
Tirfor style winch

The machine unit consists of a steel casing enclosing two pairs of automatic jaws, which grip the SWR passing through the casing. These two pairs of jaws are moved in opposite directions by means of linkages when the handle is operated backwards and forwards. This alternating operation of the handle results in a hauling or lifting movement of the rope.

WARNING
OPERATE AND MAINTAIN TIRFOR STYLE WINCHES IN ACCORDANCE WITH MANUFACTURERS' GUIDELINES.

9.3.2 Precautions in Operations

Observe the following precautions:

- a. If a single operator cannot move the load with the telescopic operating handle fully extended, the load is too great for the machine. Use a SWR block to increase the mechanical advantage. Do not extend the operating handle in any additional way.

- b. Always use slings and anchors of sufficient strength to withstand the load.
- c. Keep the wire rope wound on to the reeler when not in use.
- d. Never allow any kinks in the rope to enter the machine, as this causes internal damage.
- e. Only use the wire rope supplied with the machine.
- f. Never anchor the machine by the tip of the hook, always use slings.
- g. Never apply tension to the running end of the rope.
- h. Never step or stand over a wire rope under tension. Remain clear of the likely whip-back areas, should the rope break.

9.3.3 Safety Features

Tirfor style winches incorporate three safety features in their design:

- a. The clutch lever cannot be engaged while the machine is under load.
- b. If the strain on the lifting lever becomes too much for one rescuer, assume that the machine has reached its safe working limit.
- c. There are three shear pins in the shaft of the pulling lever. If the safe working limit of the machine is exceeded and if rope and machine are in good condition, these pins will fail before more serious damage can occur. Carry spare shear pins in the hollow handle of the machine. No special tools are required for replacement. Insert the new pins, immediately ease the load, and add blocks to the system for greater advantage.

9.4 The Ratchet Winch

The ratchet winch is a low-cost, readily available, hand-operated winch and is a useful tool for rescue, but should not be viewed as a replacement for the Tirfor style winch.

The winch has a handle that cranks a drum via a pawl and ratchet system, thus winding the wire on to the drum. Forward and reverse are achieved by a spring-loaded control of the pawl. The wire rope length and the winch capacity vary from model to model and must be confirmed prior to use.

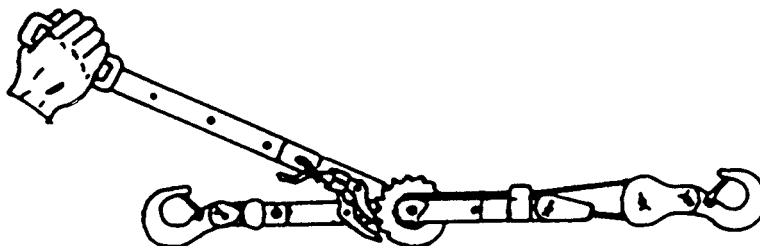

Figure 9:14
The ratchet winch

WARNING
SOME CHEAP RATCHET WINCHES ARE OF VERY POOR QUALITY AND CAPABILITY. MAKE A CAREFUL CHECK PRIOR TO USE, AND CLOSELY FOLLOW THE MANUFACTURERS' GUIDELINES.

9.5 Vehicle-Mounted Power Winches

Power winches are available in many types and variations, and each has its own particular characteristics and attributes. In all cases, carefully read the manufacturers' instructions prior to use.

9.5.1 Precautions in Operations

Observe the following precautions:

- a. Always be aware of the manufacturer's specifications and safe working load (SWL) and operate the winch within those parameters.
- b. Do not step over or stand near a winch rope while under tension. The backlash from a broken cable can be fatal.
- c. Do not hook the winch rope back over itself, as this reduces the SWL by up to 50 per cent and damages the rope. Use an approved chain, wire or synthetic fibre sling.
- d. Wear gloves at all times when handling the cable. Frayed cable can inflict serious wounds.
- e. Do not handle the cable closer than 750 mm from the drum when winching in. A loose wire may snag the glove and draw the rescuer's hand into the winch.
- f. Do not winch with less than five turns of cable around the drum.
- g. Do not use the winch for lifting casualties.
- h. Replace damaged wire ropes immediately.
- i. Mount winches on vehicles in compliance with the manufacturers' specifications and State and Territory regulations.
- j. Most winches have a shear pin, which is designed to shear if the winch is overloaded. Only replace the shear pin with a genuine replacement pin.
- k. When winching, always pull in as straight a line as possible.
- l. Before applying a load to a new wire rope, run it out to the last five wraps on the drum and spool it on to the winch under a load.
- m. Always take out the slack in the rope before applying full power to the winch. Sudden jerks may exceed SWLs.
- n. With a power take off (PTO) winch, do not release the vehicle clutch rapidly as it could shear the safety pin.
- o. Do not slip the vehicle clutch.
- p. Always wind the cable tightly. A good method for winding the cable is to extend it fully, attach it to a holdfast, and then pull the vehicle with the brakes lightly applied. Wind the entire cable with this load.

9.5.2 The PTO Winch (Mechanical Spool)

The PTO mechanical winch is operated from the power take off, attached to the gear box through a shaft, to the winch mounted on the front bumper bar of the vehicle. Control winch speed by varying the engine speed.

9.5.3 The PTO Winch (Mechanical Capstan)

This winch is mechanically the same to operate as the PTO spool winch, but differs in the spooling method. The capstan is a tapered, vertically positioned drum around which a turn or two of the winch rope is taken. When the operator applies pressure to the running end of the rope, the turning capstan causes the rope to be recovered and thus winching occurs.

9.5.4 The Electrically Powered Spool Winch

The electric winch is one in which the spool or drum is driven by an electric motor, similar to a vehicle starter motor, through a gear train. The electric motor is connected by heavy-duty cables directly to the vehicle battery.

Most modern winches have a remote control switch to operate all winch functions. The remote control switch is on a lead long enough to reach back to the driver's seat or to a safe position clear of the cable and the load. A simple 'push-pull' clutch is fitted, so that the drum can freely spool to permit faster run out of the winch rope by hand to the hook-up point.

Although the winch will operate without the engine running, it is inadvisable to do so unless absolutely necessary, due to the load the winch imposes on the battery.

Note: Plasma rope should not be used on electric spool winches with a drum brake as the heat generated could melt the rope.

Archived

CHAPTER 10

LIFTING/LOWERING TECHNIQUES

10.1 Introduction

In any disaster in an urban environment, large numbers of casualties could be trapped in upper floors of buildings, in basements or other depths, or in many other difficult or inaccessible areas. In each case, the circumstances dictate the method of rescue. This chapter attempts to provide some of the alternative methods of rescue often used. Never overlook the simple option of carrying a casualty up or down an inside stairway.

It must be stressed that the techniques included here are very basic. More-technical systems (requiring a higher level of training and expertise) can be used in many circumstances. Use the Australian Emergency Manual Vertical Rescue as a reference for these advanced methods.

All fall prevention, fall arrest and work positioning systems must comply with State/Territory requirements.

Additionally, a number of improvised techniques are included in this chapter. They are, in the main, simple techniques that use materials found or acquired on a disaster site, and which can readily be used to effect rescues.

10.2 Mechanical Lowering Operations

A range of equipment such as karabiners, descenders, climbing tape and 11 mm static rescue rope can be used for lifting/lowering systems.

Figures 10:1 to 10:7 show the descent/lowering devices in most common rescue use, along with their applications. The choice of a particular style or brand of device is entirely an individual service matter. In very general terms, the majority of rescue agencies have opted for the Whaletail and Goldtail devices due to their in line (non-twist) design, rapid heat dissipation and excellent high load control capabilities.



Figure 10:1
Figure 8 descender

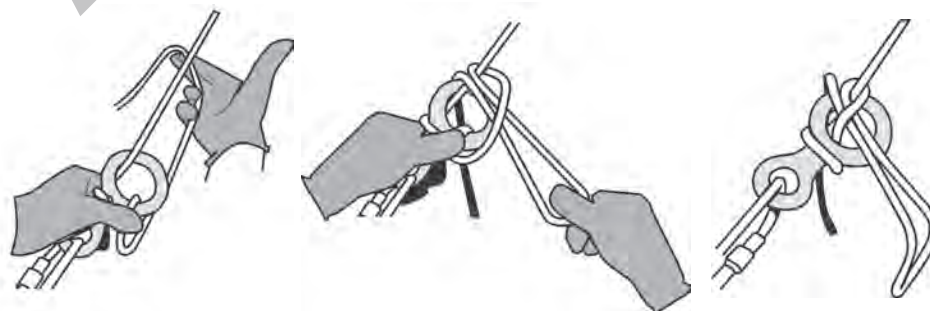

Figure 10:2
Figure 8 lock-off

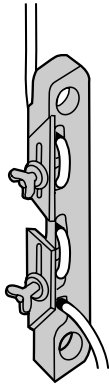

Figure 10:3
Rescue Whaletail

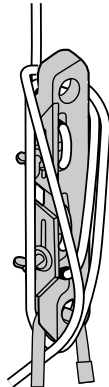

Figure 10:4
Locked-off Whaletail

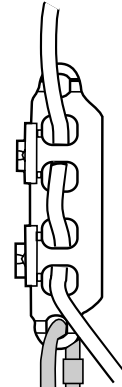

Figure 10:5
Goldtail



Figure 10:6
Locked-off Goldtail

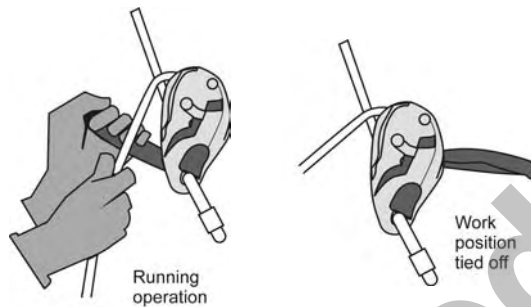

Figure 10:7
I'D self-braking descender

10.2.1 Precautions in Operations

Observe the following precautions:

- a. Make sure the keeper on the karabiner gate is screwed home—finger-tight only.
- b. Always ensure karabiners are rigged in such a manner that the keeper will vibrate closed rather than open during use.
- c. Do not permit cross-loading of the karabiner, particularly across the gate.
- d. Treat karabiners and descenders carefully. Dropping may cause hairline fractures resulting in failure under load. Where any doubt exists, remove the equipment from service.
- e. Do not cut, file or stamp descenders or karabiners. Use only paint for identification.
- f. Keep the gate lock mechanism clean.
- g. Keep all descents or lowering operations to a very slow speed to prevent excessive heat build up in the device (which could damage the rope) and to ensure that the rescuer maintains control at all times.
- h. Ensure lowering is smooth, without bouncing or jerking, to minimise loadings on anchors and equipment.
- i. Refrain from hard-breaking during a lower. This only places undue shock loading on the rope and holdfast.
- j. Ensure safety gates are properly located and secured on all descenders.

10.3 Stretcher Operations

The recovery of an injured person requires the bringing together of a wide range of rescue skills with the use of rescue stretchers. Where any doubt exists as to the casualty's injuries, always use a stretcher.

Regardless of the stretcher or recovery system, package and secure the casualty to the stretcher to prevent further injury. Where a spinal immobilisation device is used, for example spinal long boards, this must also be secured to the rescue stretcher/carrying device to prevent casualty movement within it.

Depending on the injuries, terrain and conditions, recover a casualty in either a horizontal or a vertical attitude. Wherever possible, recover casualties in a horizontal attitude.

10.3.1 Guide and Safety Lines

Attach two guidelines to stretchers during lowering operations to prevent the stretcher from spinning and in order to clear obstacles. Attach these guidelines to the head and foot of the stretcher for maximum control. Wear gloves when controlling guidelines. Attach safety lines to the stretcher as an added safety measure and belay them from above. The rescuers controlling these lines must be anchored and wear suitable gloves.

10.4 Single-Point Lower

Use an 11 mm rescue rope and a casualty support knot or a stretcher for this technique, and lower the rescuer or stretcher using an approved belay or lowering device.

10.4.1 Improvised Single-Point Lower

Use the improvised single-point lower method only when immediate evacuation of a casualty is imperative due to fire or another emergency combined with a lack of equipment.

Use an 11 mm rescue rope and a casualty support knot or a stretcher for this technique, which consists of taking two Round Turns around a sound anchor point as a belay. Use two rescuers wearing gloves and lower the rope hand-over-hand.

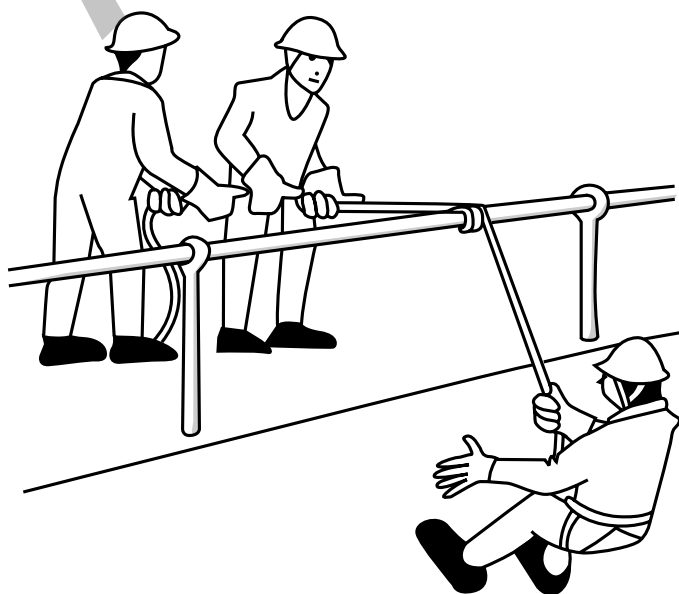

Figure 10:8

Single-point improvised lower

10.5 Two-Point Vertical Suspension

Use the two-point vertical suspension method to raise or lower a stretcher over relatively short distances, and where the casualty's injuries allow for transport in a vertical attitude.

Blanket and lash the casualty to a stretcher in the normal way, with the addition of a bandage tied across the forehead to prevent the head flopping forward if the casualty becomes unconscious.

Tie ropes to each side of the head end of the stretcher or to the manufacturer's approved attachment points. With the folding stretcher, form a Figure of Eight loop over the stretcher handle and through the 'D' on each head-end handle. Where the stretcher 'Ds' are set in toward the centre of the folding stretcher, tie the Figure of Eight loop through the 'D', and form a Clove Hitch around the handle to bring the lowering ropes to the correct position at the stretcher head.

The lowering lines are controlled by anchored belay or lowering devices.

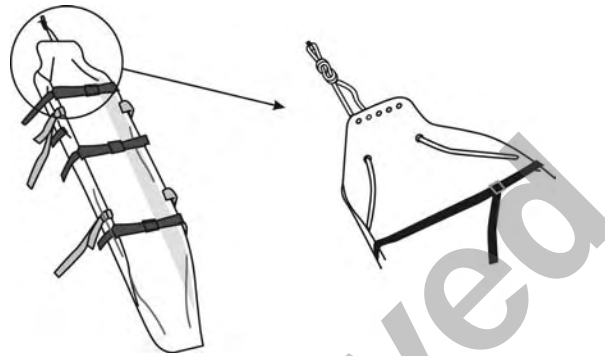

Figure 10:9
Sked attachment

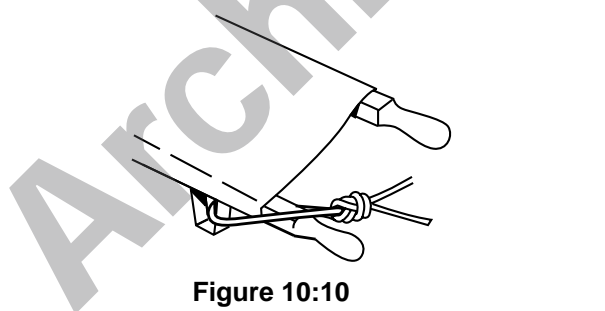

Figure 10:10
Securing lowering lines/guidelines to folding stretchers – example 1

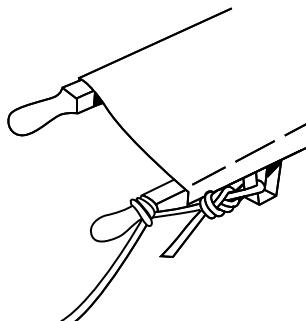

Figure 10:11
Securing lowering lines/guidelines to folding stretchers – example 2

WARNING
ONLY CONSIDER THE USE OF FOLDING STRETCHERS FOR RESCUES FROM HEIGHTS OR DEPTHS AS AN IMPROVISED TECHNIQUE WHERE NO OTHER RESCUE STRETCHER IS AVAILABLE.

When using wire basket-style stretchers, tie the lowering ropes and guidelines to the stretcher by means of a Figure of Eight loop formed over the top rail and behind the appropriate cross frame. Preferably also take the rope several times in a spiral manner around the top rail as shown in Figure 10:12 to distribute the load laterally along the rail. Tapes can also be used to attach lowering and guidelines to the stretcher and these are illustrated in Figure 10:13.

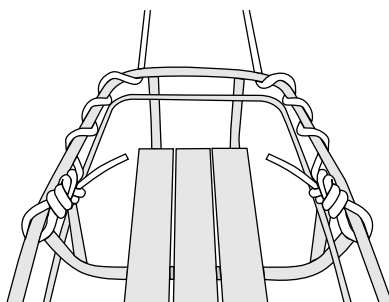

Figure 10:12

Securing lowering lines/guidelines to basket stretchers

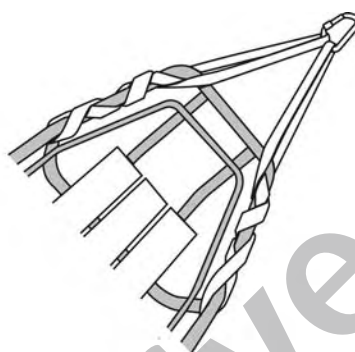

Figure 10:13

Tape attachment to basket stretcher

Use the same procedure for the foot of the stretcher and pass the guidelines out to the two rescuers on the ground. The two rescuers above ease the stretcher over the edge of the wall until they come to the lowering lines with which they lower away hand-over-hand. The two rescuers on the ground guide the stretcher clear of any obstruction and walk in on the guidelines to support the stretcher on either side as it comes down.

This technique works equally well inside a building, using a hole found or cut in the floor. If possible, do not cut through floor joists as it takes longer and weakens the whole structure. Four rescuers form the ideal team for the job as shown in Figure 10:14.

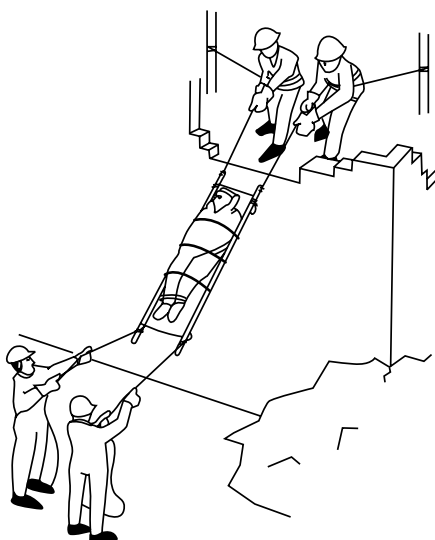

Figure 10:14

Two-point vertical suspension

10.6 Four-Point Horizontal Suspension

Where it is essential to keep the casualty horizontal, and where injuries permit, use the four point horizontal suspension with any rescue stretcher.

Rig the stretcher and attach lowering lines in exactly the same way as for the two-point suspension, except use a separate rope for each 'corner' of the stretcher. Find or cut a suitable hole in the floor and then lower the stretcher as shown in Figure 10:15.

The lowering lines are controlled by anchored belay or lowering devices.

The rescuers on the far side pull the stretcher across until it is located over the centre of the hole. This technique requires four rescuers unless the casualty is very light, in which case one rescuer positioned at the head and one at the foot of the stretcher can do the job, each controlling two ropes. If no suitable landing is available for the stretcher below, two rescuers will be required to receive the stretcher.

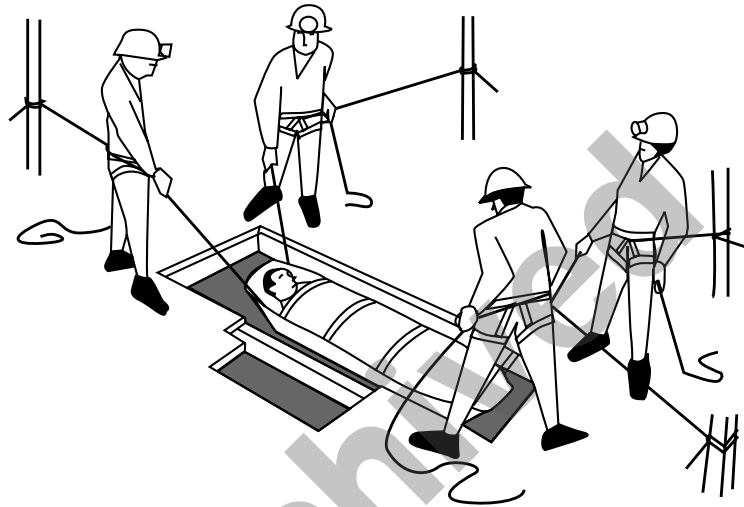

Figure 10:15
Four-point horizontal suspension

10.7 Ladder Hinge

This is a relatively simple method of rescuing a casualty from an upper floor, when it is desirable to keep the stretcher horizontal or when the building is so unstable that it cannot be used to assist in the operation. Note that the ladder is used with its reinforced side away from the structure.

Blanket and lash the casualty to a stretcher in the normal way. Place the ladder vertically against the wall in front of the opening. One rescuer supports the head of the stretcher, while another lashes the foot of the stretcher to the ladder about 250 mm above the window opening using a short length of rope (Figure 10:16a).

WARNING
THIS IS AN IMPROVISED RESCUE TECHNIQUE. THE LADDER IS USED IN A MANNER OTHER THAN THAT FOR WHICH IT WAS DESIGNED AND MANUFACTURED.

Tie a Figure of Eight loop to one stretcher top rail or handle in the same manner as for a two-point suspension. Then take the rope around the stile of the ladder in a Half-hitch and raise the stretcher until it is about 250mm clear of the windowsill. Take six to eight Round Turns around the ladder rung, Half-hitch the rope to the stile on the opposite side of the ladder, and finally secure the rope to the other side of the stretcher using a Round Turn and Two Half-hitches. Use this hitch so that the stretcher may be adjusted for lateral balance.

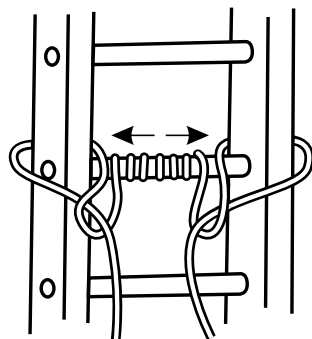

Figure 10:16a

Ladder hinge—attaching the stretcher to the ladder

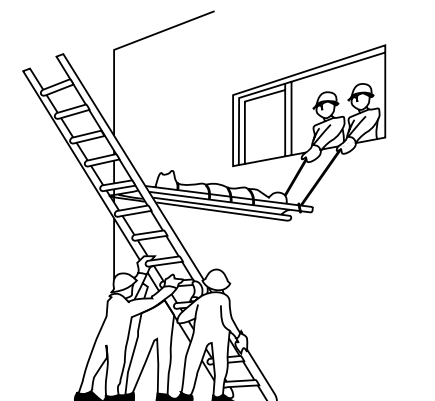

Figure 10:16b

Ladder hinge—lowering the stretcher

Attach lowering lines to the head end of the stretcher and, when all is secure, pass the word to the leader, who gives the orders 'Prepare to lower' and then 'Lower'. Pass the stretcher out the window by hand until the head end is supported by the lowering lines (Figure 10:16b). Two rescuers remain close to where the ladder has been footed to ensure no side-sway develops. One rescuer then walks backwards, hand-over-hand with each rung, controlling the speed of the whole operation. The stretcher should finally come to rest on top of the ladder flat on the ground, from where it can be quickly disconnected and the casualty removed to safety.

The lowering lines are controlled by anchored belay or lowering devices.

Note: This method can be readily used to raise a casualty.

WARNING
WHERE TIMBER LADDERS ARE USED FOR LADDER HINGE OR LADDER SLIDE TECHNIQUES, REINFORCE THE LADDERS WITH WIRE OR FIBREGLASS SUPPORT TO THE STILES.

Use tape slings and karabiners as an alternative means of forming the 'hinge' of the ladder hinge as shown in Figure 10:17.

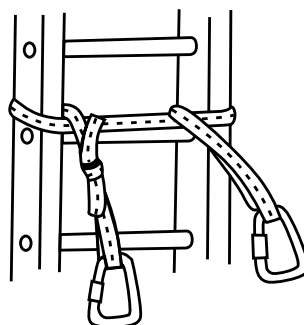

Figure 10:17

Ladder hinge with tape slings and karabiners

10.8 Ladder Slide

Blanket and lash the casualty to a stretcher, and secure two lowering lines to the head end. Three rescuers place the ladder in position at as steep an angle as possible. One rescuer foots the ladder and two act as human props as shown in Figure 10:18.

The rescuer climbs the ladder, taking two pick handles or equivalent-sized pieces of wood, one of which is passed into the building. The foot of the stretcher is passed out on to the ladder and a pick handle is placed through the two 'Ds' at the bottom of the stretcher. The stretcher is then moved down the ladder until the head end passes clear of the opening. The second pick handle is placed through the top stretcher 'Ds' and secured by taking a Round Turn around the pick handle and a Half-hitch around the handle of the stretcher on each side with the lowering rope. The stretcher is slid down the ladder, guided by the rescuer.

Where a wire basket stretcher is used, the pick handles or timber sections are not required, as the stretcher skids will slide within the ladder stiles.

The lowering lines are controlled by anchored belay or lowering devices.

Use fibreglass ladders as a last resort because of the abrasive effect of a basket stretcher sliding on the ladder. If a fibreglass ladder is used, monitor and check it regularly during a rescue operation.

Once again, this technique can be used to raise a casualty to safety.

WARNING
IN THE LADDER SLIDE TECHNIQUE, THE LADDER IS USED IN A MANNER OTHER THAN THAT FOR WHICH IT WAS DESIGNED AND MANUFACTURED. THIS IS AN IMPROVED TECHNIQUE. AS THE LOAD ON THE CENTRE OF THE SPAN WILL BE CLOSE TO 150 KG, THE SPAN MUST BE PROPPED BY TWO RESCUERS OR SHORED.

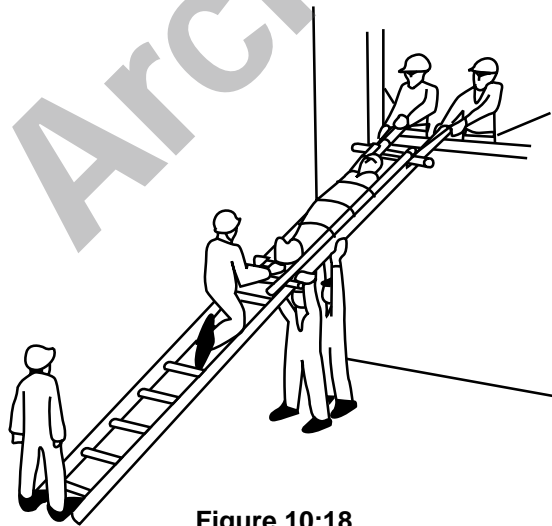

Figure 10:18
Ladder slide

Observe these specific points with the ladder slide:

- a. Where a timber ladder is used, reinforce it with wire or fibreglass stile supports.
- b. Where a wire basket stretcher is used on an alloy ladder, there will be very little friction, providing a rapid descent.
- c. Set the ladder at as steep an angle as possible for safety.

- d. Where ladders are extended to provide sufficient reach, lash the overlap with a short rope or cord.
- e. Take care with folding stretchers to keep the casualty's back clear of hauling line pulleys and latching devices on the ladder.

10.9 The Jib

The jib consists of a pole projecting about 1 m horizontally out from a structure, with a snatch block or pulley attached to the end, through which a lowering rope is reeved. It is a quick method of lowering stretchers in a horizontal position. The material used for the jib must be strong enough to allow the 1 m projection to bear all weight.

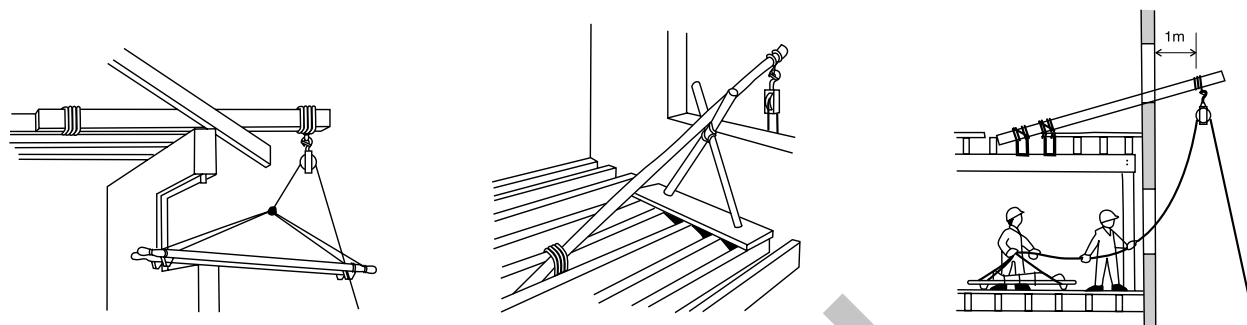

Figure 10:19

The jib—optional rigging systems

Before pushing the jib pole out, secure the pulley. To do this, 'middle' a short rope and Clove Hitch the middle of the lashing to the hook or eye of the pulley. Then cross the two running ends over the top of the pole about 300 mm back from the end. Take two or three cross-over turns around the pole and through the hook/eye, then frap the centre of the lashing, again using the cross-over turns, and finish off. Reeve the rescue rope and tie a Thumb knot 2 m back from the running end to prevent the rope running back through the pulley (Figure 10:20).

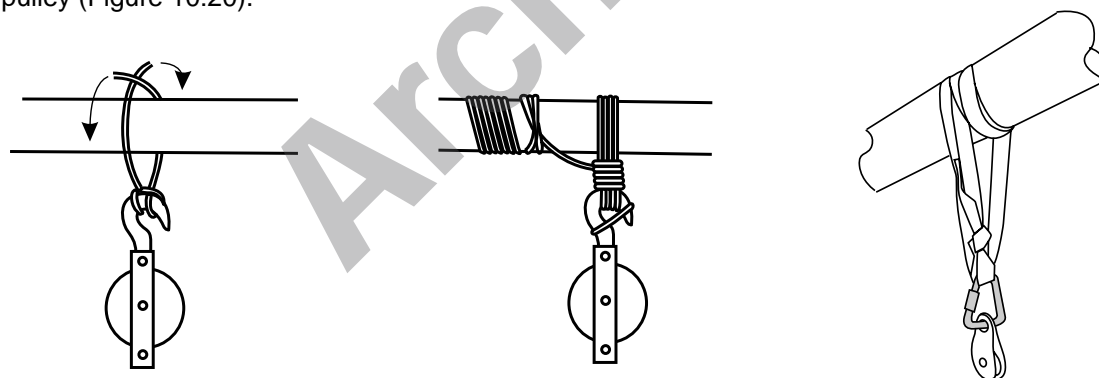

Figure 10:20

Rigging the pulley to the jib

Alternatively, safely and rapidly secure the pulley to the jib by means of tape slings and a karabiner.

It is important to reeve the lowering rope through the block, so that the running end goes directly from the block to the lowering party, and the standing part is led to the casualty by the same route by which the casualty will leave the structure.

Then firmly lash the pole in position. Make sure that the pulley is in the centre of the opening and not more than 1 m out from the wall in order to reduce leverage on the jib. It is important to lash the pole as near as possible to the point where it passes over the wall, as side strains will often be set up during the lowering operation. Secure the other end of the pole and remember this end of the pole will tend to lift. Bear this in mind when selecting an anchorage.

It is not necessary for the pole to be at right angles to the wall or to be in the horizontal plane (for example, the inside end of the pole could be anchored to a floor joist if it was solid).

Blanket and lash the casualty in the usual way and secure to the rope end in the appropriate manner. Attach two guidelines to the stretcher and pass them down to the rescuers on the ground.

Secure a friction-lowering device such as a Whaletail, Goldtail or rappel rack to an appropriate anchor point and control the lowering operation by letting rope out slowly and carefully through the device.

Where a lowering device is not available, at least two, preferably three, rescuers will be required on the lowering rope. When all is ready, take the weight on the lowering rope. The two rescuers at the top ease the casualty out through the opening, feet first. As soon as possible, the rescuers on the guidelines swing the stretcher around parallel to the structure and lowering commences. Where necessary, the guideline rescuers can pull the stretcher out to a clear landing space as it comes down. They should walk in on their lines so they are ready to take hold of the stretcher as it comes in reach.

10.10 Diagonal Lower

Use a diagonal lower to get casualties down from heights and across obstructions to the ground, while maintaining the casualty in the horizontal position. This rescue system can also be useful to assist a rescuer to remove a panic-stricken casualty from a structure (that is, to physically pull them away from the structure they are grasping or are stuck on).

The diagonal lower system keeps the casualty away from the structure or obstruction without the need for a large amount of tension on the spanline, therefore eliminating the risk of overloading.

The spanline must comply with AS 4142.3. Single spans of 11 mm rescue rope provide insufficient safety margin. Select twin 11 mm system, or single 13 mm or 16 mm, rescue ropes, to AS 4142.3.

To set up the system:

- a. Attach the spanline to a point above the casualty and secure it to an appropriate anchor. The anchor can be attached to a floor above the point of where the casualty will be dispatched from or to another appropriate elevated anchor. This permits clearance of the stretcher from the floor or ground once it is connected to the running pulley. The spanline is not tensioned at this stage.
- b. Attach the stretcher to the spanline using a double running pulley rig (Figure 10:23) or similar rigging.
- c. Attach lowering lines to the stretcher and secure using descending devices and sturdy anchors. Each of these ropes must be slightly longer than the entire span. Ensure that the rescuers controlling the lowering lines are properly fall-protected and wear gloves during lowering operations.
- d. The spanline operator on the ground establishes the anchor for the spanline and builds a 3:1 Z-rig into the spanline system to prepare the system for tensioning. It may be necessary to use an 'A' frame to assist with clearance (Figure 10:22). A releasable safety brake system is also constructed.
- e. Once the rescuers are ready to start lowering the casualty, the rescuers signal to the spanline operator to tension the spanline.
- f. The spanline operator uses the 3:1 Z-rig to tension the spanline, pulling the casualty away from the structure. Take care when tensioning to ensure that the casualty is completely free of any obstructions. Stabilise the stretcher using the lowering lines and guidelines during this process.

- g. A single spanline rescuer on a 3:1 Z-rig can tension the spanline—this will produce a tension of approximately 150 kg (<50 per cent of the SWL for 11 mm rope).
- h. The rescuers then lower the stretcher to the ground by lowering the lower lines carefully.
- i. Once clear of the structure and any other obstructions, the spanline operator may assist by lowering the spanline as required using the releasable safety brake system.
- j. Rapidly repeat the technique for each casualty if more than one casualty has to be transported. However, transport only one casualty on a diagonal lower at any one time.

Several methods may be used to form the releasable safety brake system at the base of the spanline. Use a Petzl GriGri or ID or similar descender in place of the fixed pulley in the 3:1 Z-rig (provided SWL of descender is >150 kg).

If the sag is excessive when the spanline is tensioned, there are several possible solutions:

- a. Persevere by lifting the spanline by hand at edges to help clear obstacles (this effectively reduces the span).
- b. Replace the spanline with one capable of carrying a greater load.
- c. Run a second spanline in parallel, on double pulleys, to halve the load on each rope.

WARNING
ONLY ONE PERSON IS TO TENSION THE SPANLINE USING THE 3:1 Z-RIG.
MORE THAN ONE MAY EXCEED THE SAFE WORKING LOAD OF THE WEAKEST LINK IN THE
DIAGONAL LOWER SYSTEM.

When rescue-rated ropes are not readily available in a disaster, use manila, steel wire or other synthetic fibre ropes, providing that an appropriate safety factor can be guaranteed.

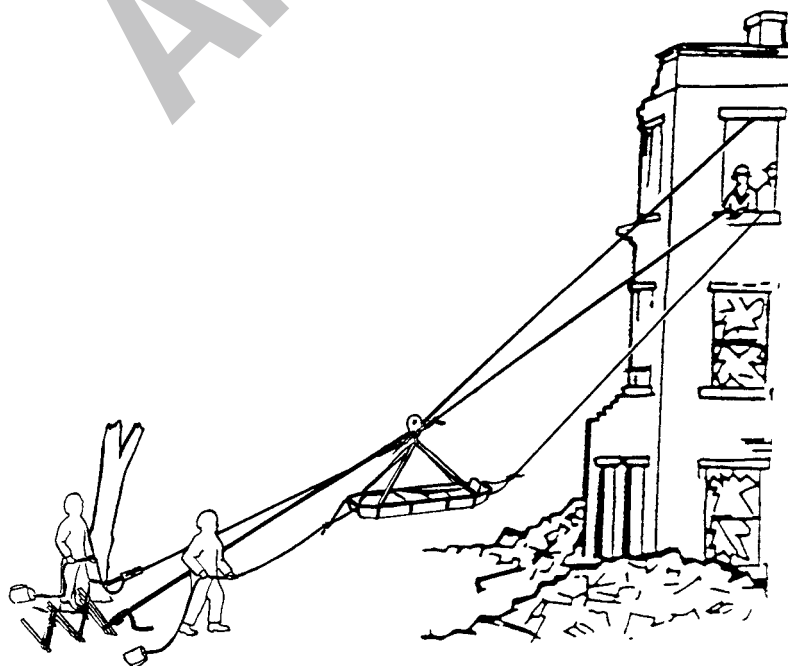

Figure 10:21
Diagonal lower

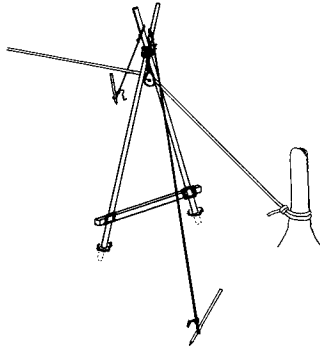

Figure 10:22
'A' frame used to gain main span height

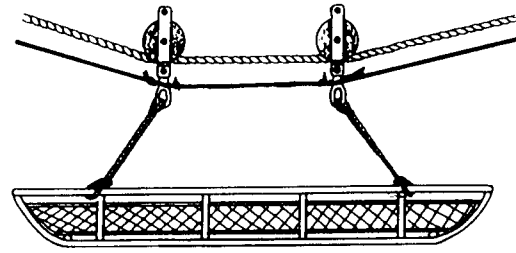
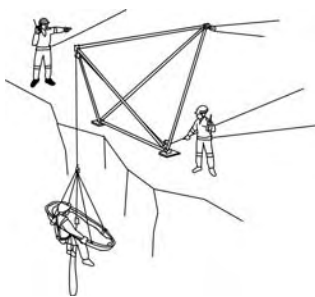

Figure 10:23
Double running pulley rig

10.11 Commercial Rescue Derricks

Commercial lightweight rescue derricks are readily available and in common use by rescue teams. All derricks of this type are designed to provide edge clearance and high pulley attachment points at the working edge in a cliff rescue, and could prove invaluable in general rescue operations.

Commercial lightweight tripods and 'A' frames are produced by a number of companies, and these, along with the cliff rescue derricks, require that personnel be trained in the use of the particular device used within their service.



(a) Larkin frame

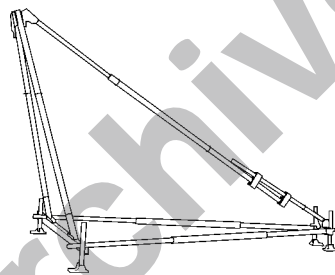

(b) Ozpod crux

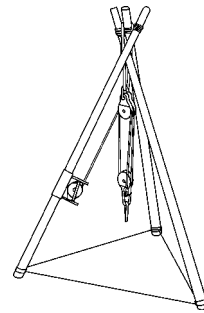

(c) SRT tripod

Figure 10:24
Commercial rescue derricks

10.12 Improvised Rescue Derricks

When no suitable crane or derrick is available in a disaster for lifting, improvise a system for the purpose. In very general terms:

- a. Derricks are formed from single or laminated upright spars.
- b. 'A' frames (also sheerlegs or sheers) consist of two upright spars with their heads lashed together and their feet splayed out.
- c. Tripods or gyns are formed by three spars with their heads lashed together.

Pay particular attention to the selection of materials for the improvisation of these rescue systems to ensure the safety of the operation. Consider the strength of the material and the height of the lift required.

Use only ropes that are appropriate to the particular task for the construction of improvised derricks, and for the guying and lift/lower operations.

10.13 The Standing Derrick

A standing or pole derrick is a single heavy-duty spar or pole (or two or more lashed together for strength) with the butt on the ground or on a sole piece, and the pole held vertical by three or four guys. A load can be lifted and moved to the right or left and to the front with this derrick, but only for a limited distance.

To support the lifting tackle and to prevent it from binding on the derrick pole, secure a short crosstree (or cross head) about 500 mm long to the derrick pole by a square lashing.

Do not shoulder or bolt the crosstree to the upright, as this weakens both the crosstree and derrick pole. Its normal position is from 450–600 mm from the head of the pole, but in all cases fix it as far down the pole as will give sufficient room to lift the load the required distance.

With any particular pole, the shorter the length of pole bearing the load, the greater the load it can carry, within the limits imposed by the type and size of pole in use.

10.13.1 Anchors

Ensure that the distance of the guy anchors from the foot of the derrick is equal to twice the height of the derrick if possible, and never less than the height of the derrick.

10.13.2 Head Rigging

If a winch is being used to lift the load, all that is required at the crosstree is a steel wire rope block, through which the winch cable is passed. Normally the block is secured with a 10 mm chain sling. Both block and chain hook must be moused.

10.13.3 Leading Pulley

To ensure that the load is supported down through the axis of the derrick, lash a leading pulley to the foot of the pole, and direct the hauling rope through the pulley (Figure 10:25).

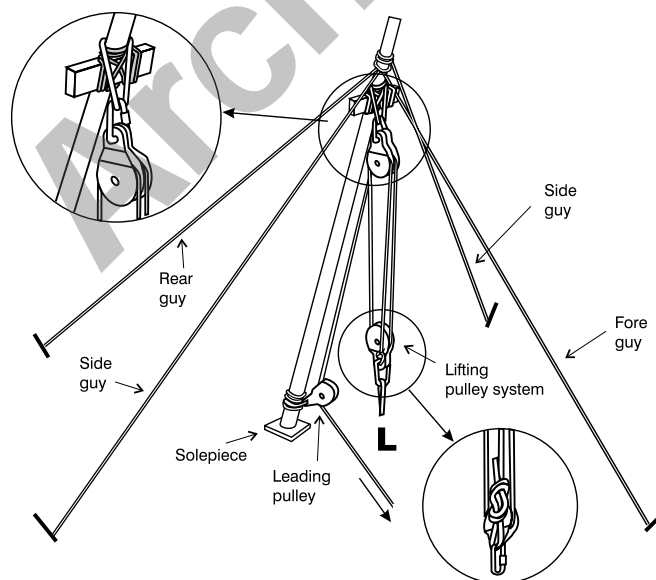

Figure 10:25

Standing or pole derrick

10.13.4 Footing

The ground on which the derrick will stand must be firm. If not, take steps to make it so. It is advisable to form a shallow hole into which the butt will be placed. If the ground is too soft to withstand the pressure of the butt, a footing of baulks of timber may be necessary. Construct the footing so that it spreads the load over a sufficiently large area of ground. Also, take care to prevent the butt from kicking back, particularly when luffing.

10.13.5 Layout and Preparation

Having chosen the position for the foot of the derrick (allowing for any necessary luffing), select the points at which guy pickets will be driven in. After preparing the derrick, overhaul the tackle to the required length and temporarily lash the lower block to the pole to prevent swinging during erection.

10.13.6 Raising

Do the initial raising by hand under the leader's direction. The guy rope at each picket is controlled by a rescuer. As the pole is raised, take in the slack on the fore guy. During erection, control the guy ropes with a Round Turn on the pickets and finally make fast with a Round Turn and Two Half-hitches.

10.13.7 Luffing

When raising a stretcher or load over an obstruction, such as a wall, it is usually necessary to luff or lean the pole slightly. When this happens, control each guy line under the direction of the leader. Since the team must work in unison, the leader must give precise directions to haul or slacken, and must not leave the rescuers to exercise their own judgment, otherwise misunderstandings will occur and lead to an accident. Never exceed one third of the height of the derrick as the maximum luff at any time the derrick is in use. The initial luff angle is one fifth of derrick height. This limit of incline fixes the distance at which a weight can be picked up.

10.14 The 'A' Frame (or Sheerlegs)

An 'A' frame consists of two poles with their butts on the ground and their heads lashed together and held in the air by fore and back guys. An 'A' frame can be used where the use of a derrick would be impracticable, such as at the ends of a diagonal lower to raise the main span rope. It can be used to move a load in a straight line by swinging it between the legs. For a given load, the two spars that comprise the 'A' Frame may be lighter than the one required for a standing derrick.

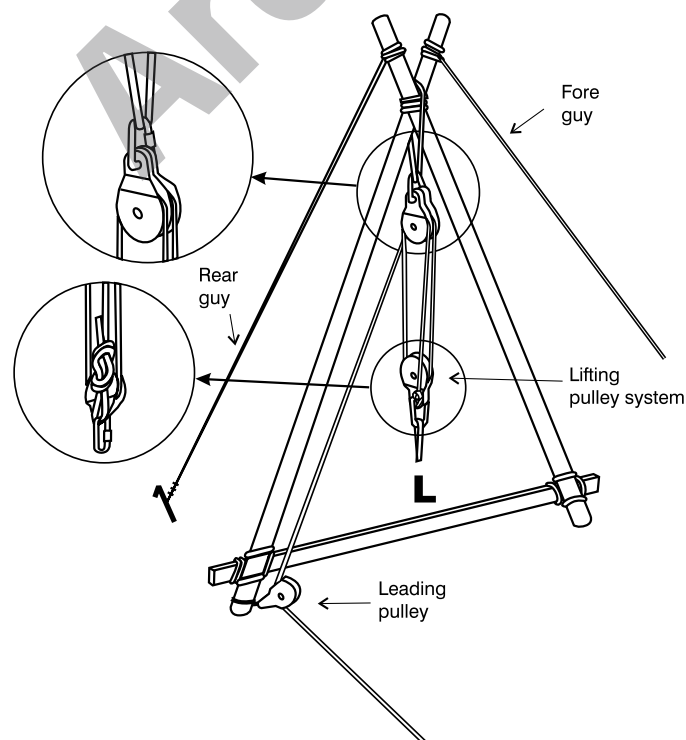

Figure 10:26
'A' frame

10.14.1 Layout and Preparation

Select two poles of approximate equal length and lay them parallel on the ground, with their butts flush together. Insert spacing pieces 50 mm thick between the poles, and lash the heads of the poles with a round lashing. Spread the butts of the poles until their distance apart is about one third of the length from butt to head lashing.

Secure the poles by tape, rope or placed pickets, or by the lashing of a cross timber to prevent the poles from splaying.

Pass a sling over the fork of the 'A' frame so that it will rest across the poles and not on the lashing between them. Prepare the lifting tackle and hook it into the sling, and ensure the lashing is suitably protected with padding.

10.14.2 Guys

Place guy line anchors at a distance of not less than twice the height of the sheerlegs from its base. The guy ropes are similar to those required for a pole derrick but consist of two only, a fore and back guy of appropriate rope. Secure the guy ropes above the round lashing by Clove Hitches in such a way that they will draw the spars together when the load comes on to them (that is, the fore guy to the rear pole and rear guy to the front pole).

Prepare the tackle to the required length and temporarily lash the lower pulley to one of the poles to prevent swinging during erection. Reeve the hauling rope through a leading pulley secured to the butt of one pole (Figure 10:26). Dig the pole butts into the ground to prevent them from kicking back.

10.14.3 Raising

Do the initial raising by hand under the leader's direction. The guy rope at each picket is controlled by a rescuer. As the 'A' frame is raised, take in the slack on the fore guy. During erection, control the guys with a Round Turn on the pickets and finally make fast with a Round Turn and Two Half-hitches. Place the butt sufficiently far from any obstruction to permit the top of the 'A' frame to be luffed over it.

10.14.4 Luffing

'A' frames are luffed by carefully paying out on one guy rope and taking in on the other. The team must work in unison under the leader's direction to ensure sound operation and prevent accidents. The amount of luff permissible is similar to that allowed in derricks (that is, the initial luff is one fifth, thereafter one third of the vertical height of the rig).

10.15 Tripods (or Gyms)

A tripod consists of three poles lashed together near the heads and with the butts forming an equilateral triangle on the ground. No guy ropes are required and the space occupied is small, but only a vertical operation is possible. A lateral pull or loading will de-stabilise the tripod and may cause its collapse. Use poles of roughly equal length and strength.

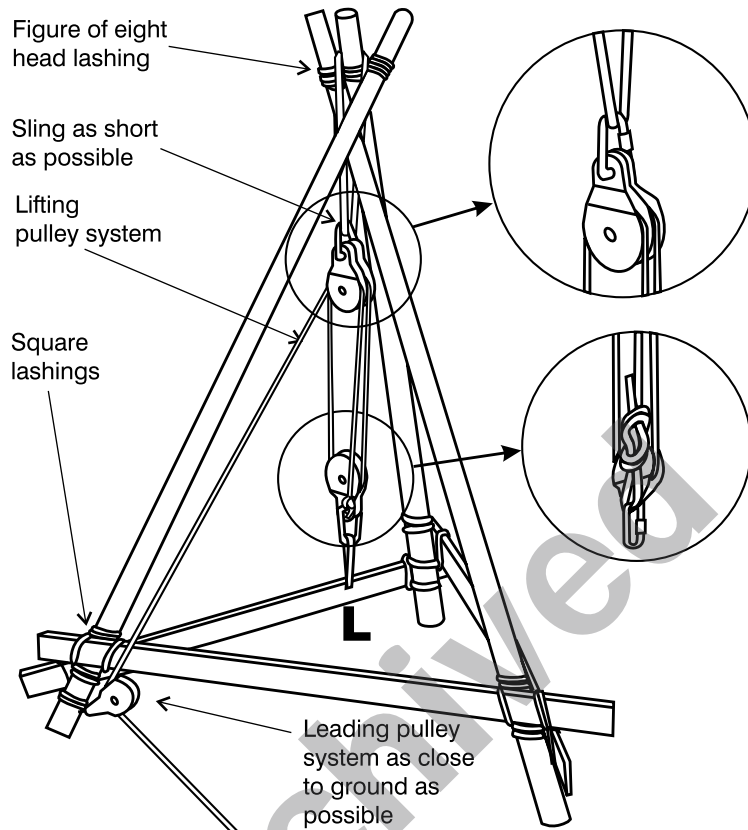

Figure 10:27
The tripod

10.15.1 Layout and Preparation

Lay out the three poles side by side, the butts flush on the ground. Mark them about 1 m down from the head of the shortest pole to show the position of the centre of the lashing. Then reverse the centre pole and place the head between the heads of the other two so that all three marks are in line.

Insert spacing pieces 50 mm thick between the poles, and lash the poles together with a Figure of Eight lashing. Then remove the spacer blocks and cross the two outer poles until their butts are at a distance apart equal to about half the effective length of the poles. The top of the centre pole rests in the fork of the other two.

Place a sling in the fork of the tripod in such a manner as to bind the poles together when the weight is taken, the lashing being suitably protected. Secure the upper pulley to the sling. Prepare the tackle and overhaul to the required length. Temporarily lash the lower pulley to one of the legs to prevent swinging during erection. Reeve the hauling rope through a leading pulley secured to the butt of one pole.

10.15.2 Raising

Lift the head of the tripod as far as possible by hand and bring the centre pole in to form an equilateral triangle. Space the butts evenly apart at a distance equal to about half the height from the butt to the lashing. They must all be on the same level or the weight will be distributed unevenly. Place the tripod so that its head is as near as possible over the centre of gravity of the load.

10.15.3 Securing

Whether a load is suspended or not, do not leave the tripod standing unless the butts are secured against slipping by one of the methods used for the 'A' frame.

10.15.4 Kickback

When redirecting the haul line at the butt of a pole, peg or lash the back pole to prevent tripod movement during hauling.

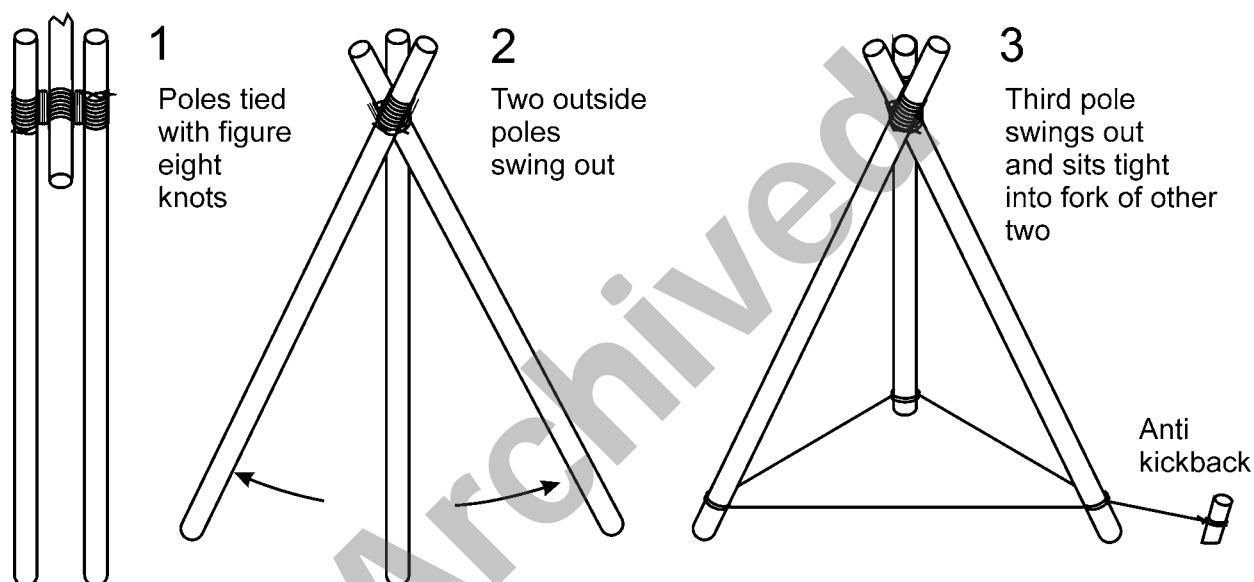

Figure 10:28

Sequential erection of tripod and anti-kickback lashing and peg

Archived

CHAPTER 11

LIFTING EQUIPMENT

11.1 Levers

The purpose of all lifting techniques is to gain sufficient power to lift or hold a large load with a small, suitably applied force. The simplest appliance for gaining this power is the lever. There are two principal ways to use a lever, as illustrated in Figure 11:1. In each case, the advantage gained depends on the distance of (A), the centre of the load and (C), the point where the force is applied, from (B), the fulcrum.

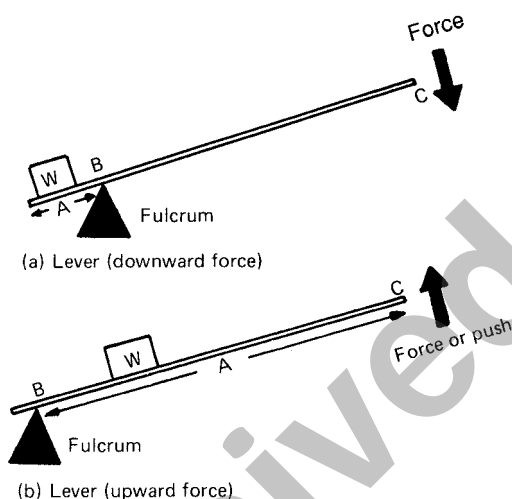

Figure 11:1
Leverage principles

11.1.1 Fulcrum Blocks

A fulcrum should be hardwood, never brick or other crushable material. It must rest on a firm base, which should be as large as practicable so as to distribute the weight to be lifted. Place the fulcrum as near to the weight as is possible under the circumstances. Do not place it at any point where there is a possibility of a casualty being buried immediately below. Make an appreciation before using the lever to ensure the equipment is strong enough, as a collapse would be disastrous to a casualty.

11.1.2 Lifting

Apply power as near to the end of the lever as practicable. When more than one lever is used, lift the load evenly.

11.2 Hydraulic Rescue Equipment

Hydraulic equipment provides a tremendous mechanical advantage, and is available in the form of a ram or spreader attachment, which can be coupled to a standard type of hydraulic pump. The power per weight of equipment can be readily appreciated by the fact that a very basic pump and ram, weighing approximately 9 kg, can lift a load of 10 tonnes or more.

The advantage of using hydraulic equipment is that a comparatively small force can be greatly increased. This is due to the fact that when a force is applied to a fluid, it is transmitted equally and undiminished in all directions throughout the fluid (Pascal's Principle).

Hydraulic tools are available in hand-operated, power-operated or air operated models.

These tools can be either single or double-acting, both of which provide a significant advantage to rescue teams. Single-acting hydraulic tools can apply a force in one direction only. Double-acting hydraulic tools apply a force in two directions and can therefore be used for pushing or pulling.

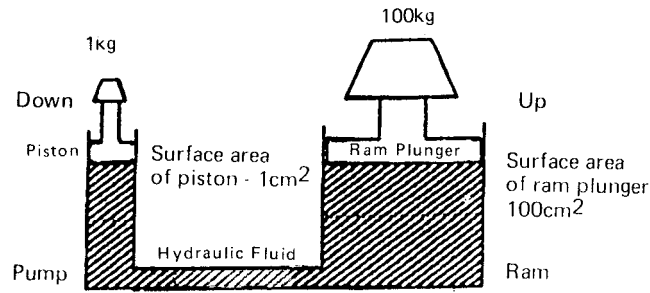

Figure 11:2

Pascal's Principle—'pressure is equal on all parts'

11.3 Power Hydraulics

Power hydraulics are widely used in all emergency services throughout Australia for many rescue tasks. The principle is the same as for hand hydraulics. The main difference between power and hand hydraulics is that power hydraulics use a motor that drives a hydraulic pump to activate the rescue tools.

The majority of these power hydraulics tools are usually for specific road accident rescue purposes (refer to the *Road Accident Rescue AEM*). However, they have an application in general lifting/cutting requirements in general rescue and USAR operations.

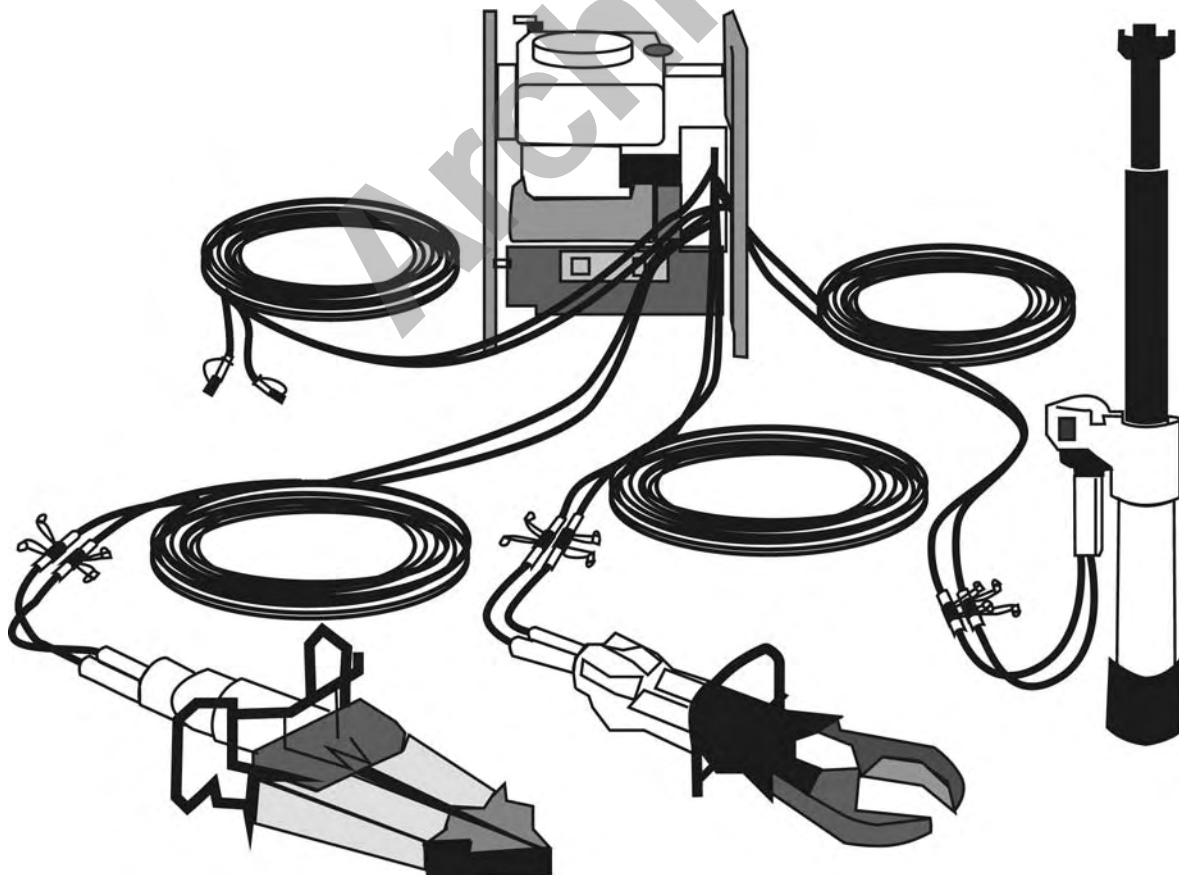

Figure 11:3

A complete double-acting power hydraulics kit

11.4 Hand Hydraulics

11.4.1 Contents of Basic Hand Hydraulics Kit

The basic hydraulic rescue kit in common use with rescue services is a single-acting, hand-operated pump system. It commonly consists of the following items:

- a. 2 hydraulic pumps
- b. 2 lengths of pressure hose
- c. 2 rams of 10 tonne capacity plus serrated saddles
- d. 2 screwed adaptors for ram plungers
- e. 1 wedge spreader
- f. 1 alligator spreader
- g. 2 flat base plates
- h. 2 ram toes
- i. 2 plunger toes.

11.4.2 Basic Kit Options (20 Tonne Lift and 5 Tonne Pull Rams, Ram Extension Tubes)

Each set has two basic jacking units (that is, two pumps and two rams) and the various fittings for each ram. In addition, one wedge spreader and one alligator spreader are provided. This is because there will be a number of jobs where two jacks working simultaneously will have to be used, but relatively few occasions where two of the same type of spreader are required together.

11.4.3 Method of Operation

The apparatus is operated by oil pressure from the pump through a hose to the ram and its accessories or to the spreaders. The various items in the kit can be connected or disconnected by finger-operated screw couplers. No tools are required. The rams and accessories can be used in any operating attitude, or even under water. When a lifting or spreading attachment has been coupled to the hose, power is applied simply by operating the hand lever on the pump after the release valve has been closed.

WARNING

IF UNDUE FORCE HAS TO BE APPLIED TO THE OPERATING HANDLE WHEN THE RAM OR SPREADERS ARE NEAR THE END OF THEIR TRAVEL, CEASE PUMPING IMMEDIATELY, OTHERWISE DAMAGE TO THE EQUIPMENT MAY OCCUR.

11.4.4 The Basic Kit Components

- a. **Pump, single-acting, hand-operated**—In a normal working position flat on the floor with the foot on the foot plate, the pump can be used in any position except with the oil reservoir pointing downwards (that is, hose connection uppermost).

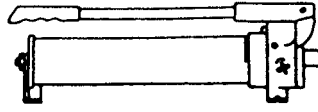

Figure 11:4

Pump, single-acting, hand-operated

A release valve is located on the side of the pump. Ensure this is tight when the load is being lifted. Unscrew it a couple of turns when the time comes for the ram or spreader to be closed. Use this control to very finely adjust lowering. Inside the head of the pump is a blow-off valve, which is designed to release when the pressure in the system exceeds 68 900 kPa. As the area of ram base is almost 13 cm², this means that the basic ram will lift almost 10 tonnes before the blow-off valve operates.

WARNING

NOT ALL OLDER PUMPS ARE FITTED WITH A BLOW-OFF VALVE. TAKE CARE NOT TO OVERLOAD OR OVER-EXTEND A RAM. THE WEDGE AND ALLIGATOR SPREADERS ARE PARTICULARLY AT RISK IN THE ABSENCE OF A BLOW-OFF VALVE.

- b. **Ram**—This is simply a compact metal cylinder, out of which extends a metal plunger when oil is pumped in under pressure. Using the ram itself on a vertical lift, 10 tonnes is the limit. If, however, the base plate and ram toe, or the plunger toe and ram toe, are being used, apply a load of not more than 5 tonnes. This is because the load is being lifted on one side of the central axis and a bending movement is set up in the ram. This bending movement will distort the ram piston and may shear off the toe units before the blow-off valve can operate.



Figure 11:5

A basic ram

- c. **Other rams**—Other lifting rams in common use with rescue teams have varying lifting strokes and capacities.
- d. **Hose**—1.8 m or 2 m lengths with a male coupler at one end and a female coupler at the other. Hoses are interchangeable and are pre-charged with oil ready for immediate use. A slight seepage of oil is of no consequence when couplings are being made or broken. Take great care to ensure inner washers are not displaced or lost and that no dust or grit enters the system when coupling up.

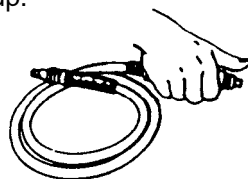

Figure 11:6

Hose

- e. **Ram toe**—This is a collar which screws on the top of the ram cylinder and has a lifting lug projecting from it. When used in conjunction with the base plate, jacking can commence from an opening of about 50 mm high.
- f. **Plunger toe**—This screws onto the threaded adaptor and, when used with the ram toe, provides a very useful type of spreader for a 30 mm opening.

Experience will dictate which one of these combinations is the correct one for the job.

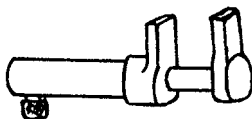

Figure 11:7
Ram/plunger toe

- g. **Wedge spreader**—Where clearances for operating the ram are minimal, insert this wedge after enlarging an opening with a wrecking bar or similar tool and then apply power to it with the pump. An initial lift of about 63 mm can be achieved, with a spreading force at the tips of the spreader of approximately 750 kg.



Figure 11:8
Wedge spreader

- h. **Alligator spreader**—This is an enlarged version of the wedge spreader. When fitting to a ram, remove the serrated saddle from the ram and insert the push rod of the alligator spreader into the hole in the ram plunger.

The alligator spreader is designed for use with the small 10 tonne rams with strokes of 50 mm and 80 mm. Do not use it with the high lift (150 mm stroke) ram as the spreader will be seriously damaged.



Figure 11:9
Alligator spreader

When closed, the spreader requires an opening of 32 mm but has a maximum opening of 305 mm. The spreading force at the tips of the spreader is approximately 1–1.5 tonnes.

Some newer kits include a 1.5 tonne alligator spreader with an integral cylinder. This does not have to be attached to a ram for operations.

11.4.5 Special Features of the Equipment

The entire kit is portable. The pump permits selective control over lifting and lowering. The flexible hose allows the ram and spreaders to be operated in a position that may be inaccessible for normal jacking equipment. It also allows the operator to keep well clear of the job. The ram and spreaders will work effectively in any position.

WARNING
ALWAYS USE HYDRAULIC RESCUE EQUIPMENT IN COMPLIANCE WITH MANUFACTURERS' RECOMMENDATIONS AND DETAILED INFORMATION.

11.4.6 Safety Points

Observe the following safety points:

- a. Operate the pump with one hand only.
- b. Do not fit extensions to pump handles for any reason.
- c. Pack as you jack.
- d. Protect couplings and hoses, which are vulnerable at all times.
- e. Wear appropriate personal protective equipment when using hydraulic equipment, that is, gloves and safety glasses etc.

Testing—Place all components under full load test, on a monthly basis, to maintain the integrity and flexibility of the seals.

11.4.7 Maintenance

Regularly check the oil level in the pump. Hold the pump vertically and remove the screw at the rear of the oil reservoir. A dipstick is attached to the screw. If necessary, add oil to bring the level up to the notch on the stick.

Use only hydraulic fluid recommended by the manufacturer. In cases of extreme emergency, however, use any non-viscous liquid, for example SAE 10 motor oil or even water. If this has occurred, drain the entire system, and flush and refill with the correct fluid at the earliest opportunity.

11.4.8 Air in the System

The system will not function effectively if air gets into it. Difficulty will be encountered in getting the ram or spreaders to extend or hold their extended position. Expel air in the following way:

- a. Connect the ram to the pump and fully extend it.
- b. Invert the ram.
- c. Open the release valve and push down on plunger until it is fully collapsed.
- d. Close the release valve.
- e. With the pump vertical (hose-end downwards), give 8 to 12 rapid strokes.
- f. Repeat the procedure 3 to 4 times if necessary.

11.4.9 Blank Caps

Whenever any item of the kit is not in use, screw the blank cap into the coupler to protect the valves from dirt and grit.

11.4.10 Accessories

Apart from keeping all screw threads clean and oiling the moving parts of the wedge and alligator spreaders, no other maintenance is necessary.

11.5 Mechanical Jacks

If hydraulic equipment is not readily available, make provision for jacks. The three types of mechanical jacks in common use with emergency services are:

- the ratchet jack
- the screw jack, and
- the high lift or Wallaby/Kangaroo jack.

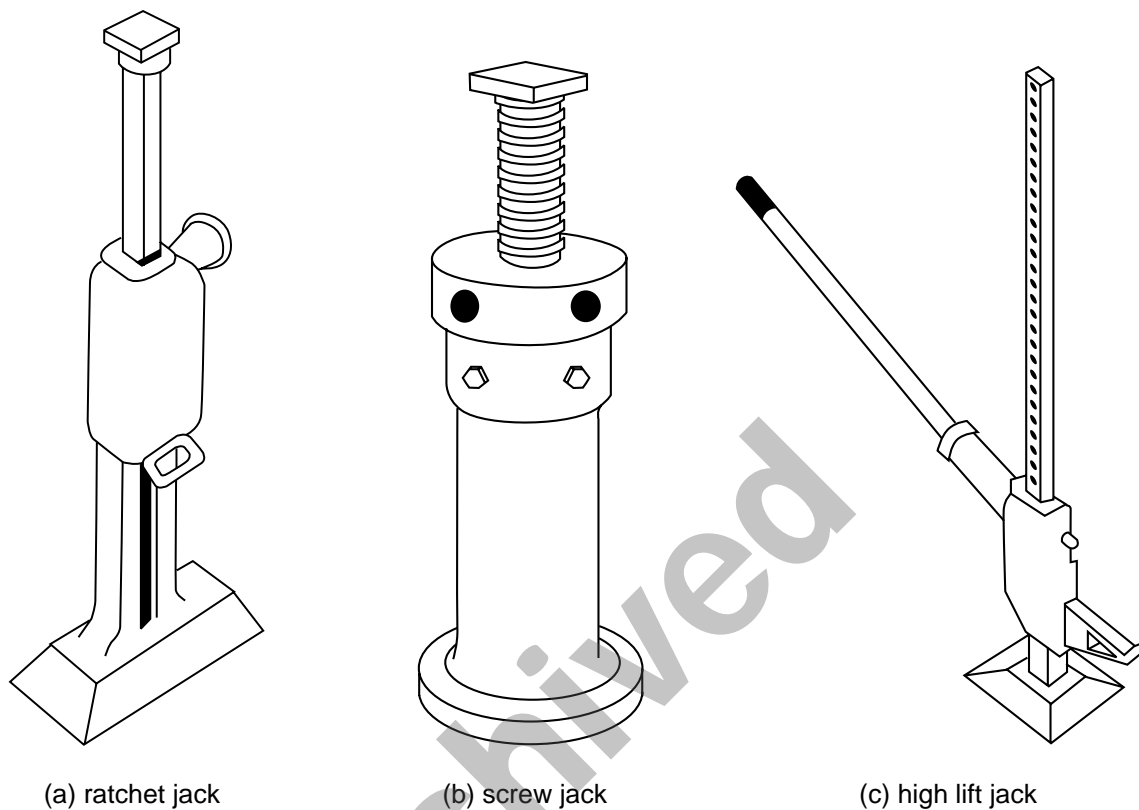

Figure 11:10

Different types of jacks

11.5.1 Different Types of Jacks

Each type of jack has its individual advantages and disadvantages, and some specific rescue applications. Exercise care to ensure that the jack selected is appropriate in style and design for the task, and that it is capable of sustaining the load to be applied.

Considerations when lifting and jacking:

- When under load, ensure a jack stands squarely on a heavy timber or other substantial footing to prevent it slipping or sinking into the ground. The footing must be dry and free from grease, so the jack will not slip.
- When jacking a metal object, consider the use of a wooden block placed between the jack and the object to prevent slipping.
- Be sure the 'up' and 'down' latch panels are not cracked on ratchet jacks.
- Always remove the jack handle when not in use.
- When using several lifting devices under one load, be sure all devices lift or lower together so that the load will not tip and that weight is evenly distributed.

11.6 Airbags (High Pressure)

Airbags are available in a large range of sizes and designs to meet specific needs. The most common in use are the mini-bags, which are supplied in sizes ranging in lifting capabilities from 9.6 tonnes to 67.7 tonnes.

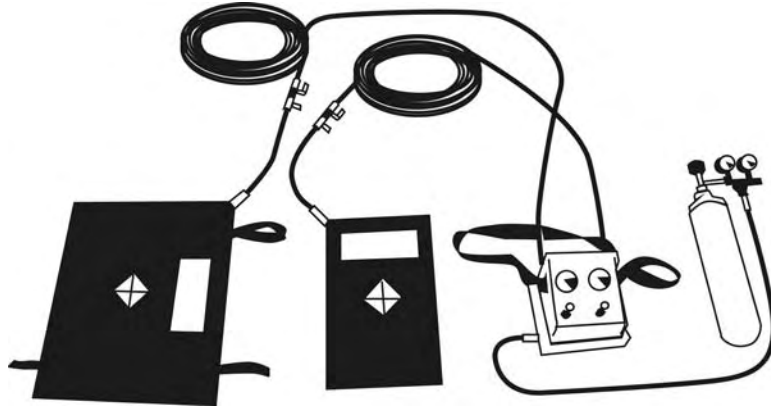

Figure 11:11
Airbag system

Height of lift or width of spread will be governed by the size of the bag relevant to the amount of force required.

11.6.1 Safety Warning

Stack high-pressure airbags to gain extra height only in accordance with the manufacturers' directions. Use cribs as for mechanical jacking.

11.6.2 Airbag Advantages

Airbags have the advantages that they:

- require only a small gap
- are fast to operate
- can lift on soft, uneven ground or inclined positions, and
- are unaffected by dust and dirt because they have no moving parts and are maintenance-free.

WARNING
ALWAYS USE AIRBAGS IN COMPLIANCE WITH THE MANUFACTURERS'
RECOMMENDATIONS AND DETAILED INSTRUCTIONS.

11.7 Cribbing and Wedges

Cribbing provides a temporary footprint, which should be used to support loads during rescue operations that require lifting or jacking.

As the load is lifted, continually place solid material supports under it to prevent damage should the jack collapse. This is known as the 'pack as you jack' principle. Do not allow the weight of raised sections of walls and floors to rest entirely on the jack while rescue workers crawl under. Set cribs under heavy loads or sections of floors to prevent settling after the lifting operation is complete. Cribbing can be built with timbers of various sizes from 600mm–3m in length, depending on the weight to be supported and the available working space.

Be sure that the ground is level at the point where the crib is to be set. It is better to level off high spots than to fill low ones.

The cross-tie crib (Figure 11:12) is a safe method of supporting heavy weights. Space several timbers well apart and parallel, then place a second level of timbers on top and at right angles to the first layer. Each added layer is at right angles to the previous layer. The number of layers needed depends on how high the load is to be lifted.

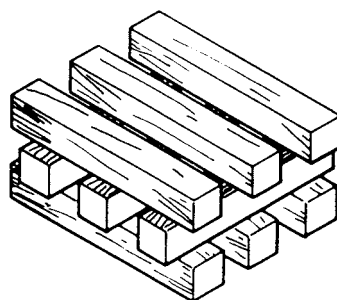

Figure 11:12
Cross-tie cribbing

Some rescue situations may require cribbing to be used in shapes other than a square. This is referred to as angled cribbing. This is particularly useful if there are objects that restrict the use of parallel box cribbing. The surface area is decreased but the capacity and stability of the cribbing is not diminished as long as the full load transfer points have full contact to the tier below.

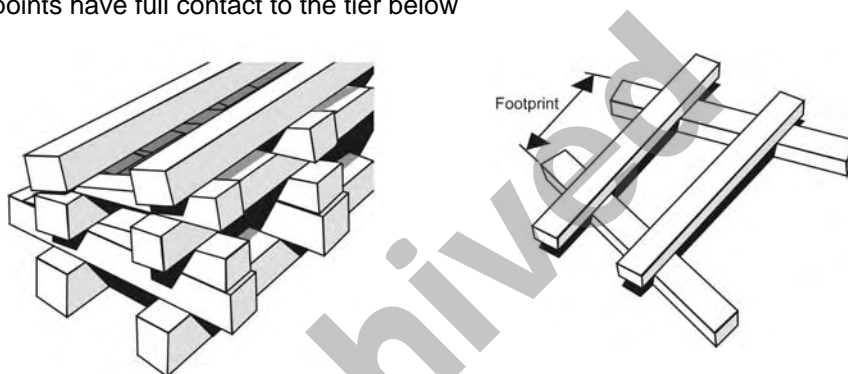

Figure 11:13
Angled cribbing

Wedges should be used to fill voids between the load and cribbing pieces. Ideally, wedges should be cut with an angle of 10 degrees.

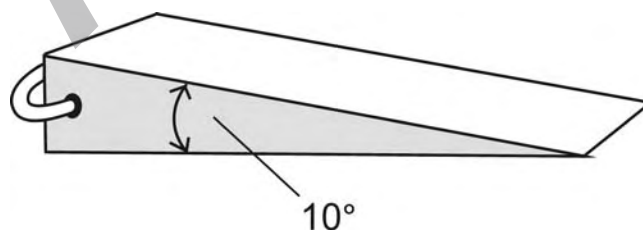

Figure 11:14
Wedges with angles of 10 degrees

Step chocks (Figure 11:15) are ideal for packing when performing a side lift. Wedges can be used with step chocks to obtain a greater surface area on the object that is being supported.

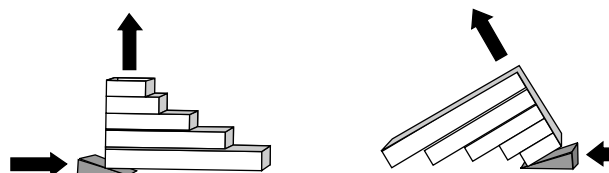

Figure 11:15
Step chock

11.7.1 Considerations when using Cribbing and Wedges

- a. Always crib from a safe area, giving yourself a safe position to work from.
- b. Use another piece of timber or cribbing to slide the required piece of cribbing into place.
- c. Do not place hands and feet under objects being cribbed or lifted.
- d. When raising and cribbing a heavy object, never raise one side of the object higher than half the height of the opposing cribbing block height.
- e. Do not use mechanical equipment for a prolonged period or as a permanent crib.
- f. Ensure direct transfer of weight is through the load transfer points.
- g. Do not stack the cribbing blocks more than two high in the same direction.
- h. 100 mm x 100 mm cribbing will support 2700 kg for each solid point of contact.
- i. Cribbing should not be higher than three times the base width.

Archived

CHAPTER 12

CUTTING EQUIPMENT

12.1 Introduction

The rescuer needs to be proficient in the many methods of cutting away obstructions without creating a hazardous situation. This can only be achieved with regular training, and a total familiarity with the tools being used and the hazards that may be encountered.

WARNING
IN ALL CUTTING OPERATIONS, TAKE SPECIFIC CARE TO AVOID CUTTING THROUGH CONCEALED SERVICES SUCH AS ELECTRIC WIRES, AND GAS OR WATER PIPES.

There are a number of hydraulic cutters or shears in use that are either hand-operated or power-operated, with either single- or double-acting operation. Some of these cutters and shears can be operated with the basic hydraulic kit described in Chapter 11.

It is important when using cutters to start and keep the jaws of the cutter at a right angle to the material being cut, to prevent excessive load on the jaw pins and blades. Unless the bite is at a right angle, there is a tendency for the metal to skid between the blades. This may damage the equipment. Never fight against the movement of the shears. Let them find their own balance without scissoring across the metal being cut.

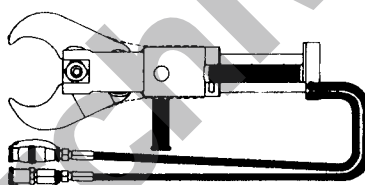

Figure 12:1
Hydraulic cutters

12.1.1 Precautions in Operations

When using shears to cut rods, you must ensure that the rod ends are secured.

To minimise the danger of the cut material springing and causing further injury, release the cutters and take several bites, thus allowing the surface tension to dissipate.

WARNING
CAREFULLY STUDY MANUFACTURERS' HANDBOOKS AND RECOMMENDATIONS PRIOR TO COMMENCING ANY CUTTING OPERATIONS, AND STRICTLY OBSERVE ALL OPERATING PROCEDURES AND SAFETY MEASURES.

12.2 Power Saws

12.2.1 Rotary Saws—Metal and Masonry Cutting

Rotary saws can be used to cut through metal and concrete. Make the cuts at right angles to the surface. These saws are dangerous because they throw out sparks and pieces of rotating blade. Never use them in an explosive or confined space.

Only experienced operators should attempt any operational work with this tool, and full protective clothing including safety goggles must be worn at all times. Ensure eye and ear protection is worn by the operator and by casualties if possible.

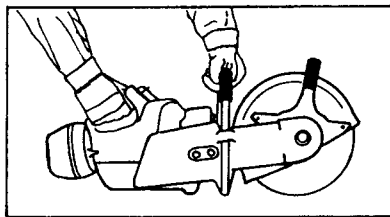

Figure 12:2
Rotary saw

12.2.2 Circular Saws—Wood Cutting

Circular saws are used for timber cutting and can be a valuable aid in debris clearance and tunnel construction. Always use the blade guard and allow the saw to cut at its own speed. Ensure saw blades are sharp and properly maintained. Do not, at any stage, permit the electrical cord to stray near the blade. Ensure eye and ear protection is worn by the operator and by casualties if possible.

Use drop and compound mitre saws for the construction of shores and cribbing.

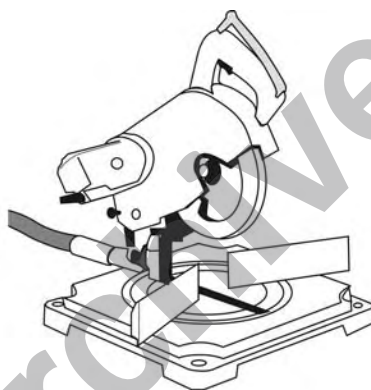

Figure 12:3
Compound mitre saw

12.2.3 Angle Grinders

While not strictly saws, angle grinders can be used with cut-off discs or grinding wheels to cut through metal panels or sections.

12.2.4 Reciprocating Saws (Jig Saws)

Reciprocating saws (jig saws) can be used for cutting metal or wood sheeting. Make the cut at right angles to the surface and keep the sole plate in contact with the metal being cut. Ensure eye and ear protection is worn by the operator and by casualties if possible.

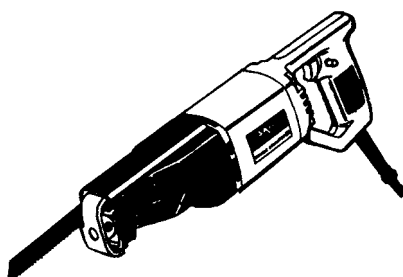

Figure 12:4
Reciprocating saw

12.3 Battery-Powered Cutting Tools

All types of cutting tools are available in battery-powered versions. These tools offer many advantages such as portability and ease of use on roofs, and have no power supply to run or be wary of. The disadvantages are that the endurance of the battery pack may not match the duration of the required job, and the batteries require regular maintenance.

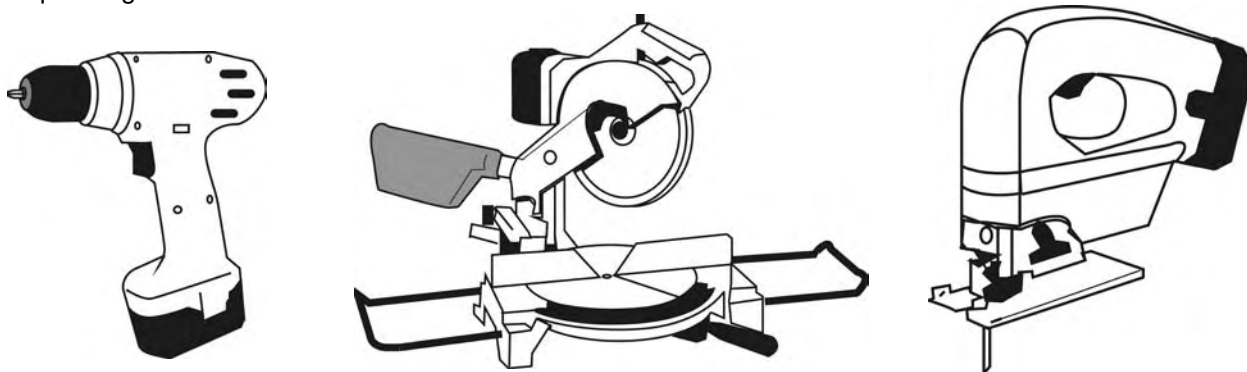

Figure 12:5
Battery-powered tools

12.4 Air-Powered Cutting Tools

Compressed air-powered hacksaws and chisels can be used to rapidly and safely cut through metal panelling and sections. Adhere to all normal safety precautions for cutting operations.

12.5 Chainsaws

The chainsaw can be a valuable aid to the rescuer, provided the machine is used correctly. Restrict the operation of chainsaws to fully trained operators. Never attempt operations beyond your capacity or experience.

12.6 Hand Tools for Cutting

12.6.1 Bolt Cutters

Bolt cutters come in a variety of sizes and styles, but most are capable of cutting through 8 mm mild steel. This makes the tool valuable for debris clearance, to cut reinforced concrete and to remove padlocks and security grills in areas where it is suspected casualties may be.

12.6.2 Hacksaw

A hacksaw can be used in many situations. Always cut at right angles to the job. Use a wedge to alleviate pressure on the blade. Cut as close as possible to a supported section of the metal.

Assist cutting by using a solution of 6:1 water/detergent to lubricate hacksaw cuts.

12.6.3 Axe

An axe can be used to cut timber or sheet metal. When used to cut sheet metal as an improvised measure, drive the axe into the sheet so that the blade penetrates to approximately half the depth of the cutting surface. Pull the handle upwards so that the head is almost parallel with the metal. A second rescuer drives the axe head down with a sledgehammer while the first guides it with the handle.

This technique can be used for cutting through galvanised corrugated iron and similar construction materials.

12.6.4 Handsaws

Do not neglect other types of handsaws, such as the bow saw, general purpose saw, rip saw etc, which have a part to play in the rescue tool kit. Remember to train with hand tools because in a disaster they may be all you will have.

12.7 Cutting with Oxy-acetylene

The use of oxy-acetylene equipment and the thermal lance are specialist tasks. Do not attempt to use these without proper training and considerable practice. The equipment is potentially dangerous in the hands of unskilled workers.

Archived

CHAPTER 13

POWER EQUIPMENT AND LIGHTING

13.1 Generators

Numerous brands and types of generators are available commercially but all are basically similar in construction. They have a frame or case and, for safety reasons, are fitted with some form of Earth Leakage Circuit Breaker (ELCB) or residual current device (RCD) and a motor-driven alternator to produce 240 volts AC. The ability of the alternator to deliver current is measured by its power output rating in watts. A power rating is also often rated in kilowatts (kW), that is:

$$\frac{\text{WATTS}}{1000} = \text{KILOWATTS}$$

13.1.1 ELCBS and RCDS

ELCBs and RCDs are commonly used methods to describe the same thing. All portable generators are built to minimise the possibility of electric shock. This is achieved with equipotential bonding and either isolated winding or an ELCB/RCD.

Equipotential bonding is the minimum and most essential for safe operation of portable generators. All portable generators should have equipotential bonding housing, motor and frame and outlet socket as per AS 2790.6.1.8.

For portable single-phase generators, an acceptable safe configuration is either:

a. **Option 1—Floating (isolated) windings, without an ELCB/RCD**

With an isolated winding there is no loss of power in the event of a single fault in the generator or in the load. Nor is there any indication of such fault. Accordingly, it is ideal for lighting. A person touching 'live parts' will receive no shock.

b. **Option 2—Polarised (frame-connected) windings with an ELCB/RCD**

With a frame-connected winding plus RCD, a single fault on load-side equipment will trip the RCD and cause loss of power. A person touching the 'live parts' will receive a minor shock but will be protected by the RCD.

Test portable ELCBs/RCDs every 3 months as per AS 3760. Test other devices every 12 months. If frequently used in harsh or severe environments, test them at 3 month intervals using the procedures set out in AS 3760.

13.1.2 Power Output of the Generator

Rescuers must know how to describe the amount of power that a particular appliance will draw, so as not to overload the generator.

Lights and heating appliances are normally rated in watts. Therefore, when using lights only, it is a simple matter to add the wattage of the number of lights being used and subtract the figure from the generator capacity to calculate the power still available.

Example: assume that three banks of lights, each drawing 500 watts, are being used:

TOTAL WATTAGE IS 1500 WATTS.

If a generator is rated at 2500 watts, or 2.5 kW, it can be seen that there is still 1000 watts capacity left in the generator.

Appliances using electric motors (for example drills, chainsaws, refrigerators, fans etc) often indicate the amount of current drawn from the generator, not the power. This is usually found on a compliance plate on the appliance and is rated in amperes or amps.

POWER (IN WATTS) = VOLTAGE (240) X CURRENT (AMPS)

Example: if an electric chainsaw is rated at 5 amps, the power it draws from the generator is:

POWER (IN WATTS) = 240 VOLTS X 5 AMPS = 1200 WATTS

It can be seen that this particular chainsaw can be run from a 2500-watt (2.5 kW) generator, but not from a 1000 watt (1.0 kW) generator.

Rescue teams should calculate the power rating of each appliance likely to be used and clearly mark this figure in watts on the appliance to save time and possible overload problems during an emergency.

WARNING

MOTOR STARTING CURRENT IS APPROXIMATELY FIVE TIMES THE RATED FULL LOAD CURRENT OF ELECTRIC MOTORS. WHEN SELECTING GENERATORS FOR MOTOR STARTING, CONSIDER THIS FACTOR TO AVOID OVERLOADS.

13.1.3 Precautions in Operations

Any combination of heat, petrol and electricity creates a potentially dangerous situation. Observe the following list of precautions when operating any generator:

- a. Do not place combustible material on or near the generator.
- b. Operate the generator on a stable, level surface to prevent fuel spillage, excessive vibration and oil starvation.
- c. During use, keep the generator at least 1 m away from buildings and other equipment.
- d. Avoid placing anything around the generator or covering it up. Generators are normally air-cooled and require a free flow of air to prevent overheating.
- e. Always stop the engine before refuelling.
- f. Be careful not to spill fuel on the generator. If fuel is spilled, wipe the machine dry before starting the engine.
- g. Do not fill the fuel tank above the designated level.
- h. Do not smoke when refuelling, or expose the process to naked flame.
- i. Keep a suitable fire extinguisher nearby and upwind of the generator at all times.

- j. Do not operate the generator in or near locations with poor ventilation such as tunnels, under houses, inside tents etc. Carbon monoxide poisoning rapidly results from a build up of exhaust gases.

13.1.4 Electrical Safety Precautions

The electrical output of generators is lethal. Observe the following safety points:

- a. Keep the generator dry. Exercise great care when operating in wet conditions.
- b. Never connect a generator to a household system.
- c. Completely unwind coiled leads before use.
- d. On-the-job surveillance of all electrical equipment, particularly leads, continues to be the rule. Make checks when stowing or withdrawing equipment from storage.
- e. Multiple outlets on floating generators are permitted if all equipment is:
 - i) double-insulated or equipotential bound, and
 - ii) regularly tested as described in section 13.1.1.
- f. Ensure that all inspection and testing of electrical equipment is carried out by a competent person as defined in and in accordance with AS 3760:2003.
- g. Ensure all electrical equipment, including generators, leads and fittings, is tested within each 12 month period. Tag the equipment to indicate the date of inspection and name of the person inspecting it.
- h. Vehicle-mounted generators:
 - i) Protect external generator outlets against the ingress of water by way of weatherproof fittings that conform to Australian Standards. Use standard fittings if the outlets are located undercover in equipment bays or the interior of the vehicle.
 - ii) Ensure protective covers on all electrical equipment and extension lead connections conform to Australian Standards.
- i. Ensure vehicle-mounted outlets are controlled by a double pole switch.
- j. Use heavy-duty flex for all extension leads.

13.1.5 Generator Operational Checks

Before operating any generator, read the manufacturer's instructions and:

- a. check sump oil level
- b. ensure the correct fuel is used, and
- c. use correct starting procedures.

13.1.6 Generator Maintenance

Properly maintain generators to the manufacturers' specifications if reliable and long service is to be expected. Regularly run generators under load.

13.1.7 Storage

Many generators used by emergency services have periods where they may not be used for some considerable time. If this is the case, always store the generator with the piston in the compression stroke, thus closing both the inlet and exhaust valves and also closing the breaker points.

This procedure prevents corrosion of the combustion chamber and the contact points, and prevents the valves from sticking open when the generator next needs to be started. Find the compression stroke by pulling the starter cord or turning the starter pulley until it becomes hard to turn (the piston is rising on the compression stroke) then continue to turn the pulley until just before the top of the piston stroke.

Drain the fuel from both the tank and the carburettor. Fuel left for long periods in the carburettor can cause a chemical reaction, which adversely affects carburettor components.

13.2 Lighting

Working at night can increase the dangers involved with rescue work due to shadows, glare and poor vision associated with artificial lighting systems. Rescuers should experience night rescue situations in training and experiment with various lighting arrangements, so as to eliminate as much as possible the three hazards mentioned.

13.2.1 Positioning Lighting

Little in the way of guidance can be given when lighting the rescue scene because all scenes vary greatly, but the following points are valid for most situations:

- a. Position lights as high as possible to illuminate the area required.
- b. If working at heights, do not shine lights from below to illuminate the situation. Rescuers on rooftops can suffer a temporary and unsafe loss of night vision by looking down into lights.
- c. If lights cannot be positioned above the scene, use hand lights or helmet-mounted lights only, controlled by the rescuers working at the height.
- d. If temporarily blinded or suffering a loss of night vision for any reason, stay still and do not move until night vision returns.
- e. Illuminate a rescue scene with a soft, medium-density light for movement within the area, and illuminate the particular work scene with higher-intensity lights such as spot lights.
- f. Position lights so that large shadows are minimised.
- g. Keep lighting leads away from dangerous areas where damage is likely to occur.

CHAPTER 14

DAMAGE TO BUILDINGS, DEBRIS CLEARANCE & TUNNELLING

14.1 Building Construction

Rescuers participating in USAR operations need to have an understanding of the various types of construction and how they are likely to behave during and after collapse. Rescuers must also know how to recognise collapse patterns likely to create voids to assist in determining possible victim locations and search priorities.

14.2 Structural Standards In Australia

In Australia, structures have to conform to the Building Code of Australia (BCA), which is a set of regulations that ensure acceptable standards of design and construction. The BCA also makes sure that standards of structural integrity and stability, fire safety, health and amenities are maintained.

The BCA classifies all Australian structures into ten classes, according to the structure's:

- a purpose
- b occupancy
- c occupants' activities, and
- d use.

For structure collapse incidents, risks associated with collapse should be the same across Australia and across all classes of structures.

14.3 Types of Construction

There are several types of construction commonly used in Australia. These types all behave differently when subjected to forces that lead to structure collapse. An understanding of the various types of construction helps rescuers to appreciate how these structures may perform during a structure collapse incident.

The most common types of construction are:

- a. timber (weatherboard)
- b. light frame (brick veneer)
- c. reinforced masonry
- d. un-reinforced masonry
- e. concrete tilt-up, and
- f. reinforced concrete and steel construction.

14.3.1 Timber

Buildings with a timber construction usually consist of a:

- a. light timber frame with cladding
- b. timber subfloor or concrete slab, and
- c. light framed timber roof or trussed timber roof clad with either sheet iron or tiles.



Figure 14:1

Examples of a timber frame construction

The external walls can be clad with many different types of materials including timber weatherboard or cement sheeting.



Figure 14:2

Completed timber frame (weatherboard) building

Timber buildings behave well under forces because they are typically light, tough and well connected.

14.3.2 Light Frame (Ordinary Construction Weatherboard/Brick Veneer)

Light frame structures are made up of a light timber, steel or solid brick frame. They may have brick veneer and timber or masonry cladding. The roof can be clad with tin or tiles.

Light frame buildings behave much like timber buildings.



Figure 14:3

Light frame (brick veneer) building

14.3.3 Reinforced Masonry

Reinforced masonry construction is made from bricks, besser blocks or concrete blocks formed into walls using standard mortar joints. Concrete grout fills the cavities between the internal and external bricks or blocks.

Reinforced steel rods are normally secured into the concrete slab and run inside the brickwork to provide tension and shear resistance. A light gauge mesh is also put on the mortar bed to help with reinforcing.

This type of construction will perform better in a structure collapse incident than un-reinforced masonry, as the grout and steel reinforcing provide greater structural stability.



Figure 14:4

Reinforced masonry



Figure 14:5

Completed reinforced masonry construction

14.3.4 Un-Reinforced Masonry

Un-reinforced masonry is the standard brick or besser block wall that is found in average brick veneer houses or shop fronts.

These walls are made by using mortar to join the bricks or blocks without the use of any reinforcing such as steel rod or mesh. The strength of the mortar can vary depending on the age of the building and the quality of the work when it was built.



Figure 14:6

Un-reinforced masonry with a rendered facade

When built as a load-bearing wall, bricks are laid to a certain height as a double-brick wall and then a brick turned on its side is laid to bond the two courses together.

Un-reinforced masonry is often used in the construction of parapet walls. This subjects rescuers to a particular danger. The light gauge ties often tie the un-reinforced masonry to the load bearing structure, which can easily tear off when subject to forces. These parapet walls are often built higher than the building to hide rooflines or to provide advertising space on commercial buildings. Always be aware of the risks with parapet walls.

Structures built with un-reinforced masonry are generally older, which causes the brick or block work to become brittle.



Figure 14:7
Un-reinforced masonry (besser block) construction

14.3.5 Concrete Tilt-up

Concrete tilt slab construction is now one of the most popular methods of construction in commercial and industrial areas, and even in multiple occupancy residential construction.



Figure 14:8
Concrete tilt-up construction

A reinforced concrete slab is poured off-site. It is then transported to the site, where it is 'tilted' into position to form walls.

A common danger associated with this type of construction is that the pre-cast slab fails at the point where it is connected or tied to the frame or other slabs. This results in a progressive failure that resembles a falling deck of cards.



Figure 14:9

Tilt-up construction bolts and tag

A tilt slab may give no indication of potential collapse. It falls either in or out, usually as a whole slab.

Internal floors and walls are connected to the tilt slab and can cause local collapse.

14.3.6 Reinforced Concrete and Steel Construction

Reinforced concrete and steel construction is very popular in modern building construction of large commercial buildings and office blocks. The method of construction involves pouring concrete around steel reinforcing bars or mesh in such a way that the two materials act together upon setting.



Figure 14:10

Unfinished reinforced concrete and steel construction

Collapse can cause parapets and full walls to fall off the building due to inadequate anchors. Large steel beams and reinforcing in concrete will be found in the debris of a structure collapse. Brick walls can split and break at openings.

14.4 Stresses and Loads on Structures

Structures are designed and constructed to withstand certain stresses and loads under normal conditions according to standards specified in the BCA. The types of stresses and loads acting on structures include:

- a. tension
- b. bending
- c. shearing, and
- d. compression.

14.4.1 Tension

Tension is the stretching of structural members such as timber or steel. When certain tensions are applied to timber or steel, they will stretch like a rubberband and return to original length.

Concrete and masonry, such as a brick wall, behaves poorly under tension. Masonry becomes brittle and will break without warning.

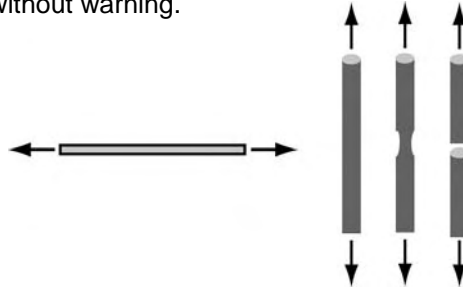

Figure 14:11
Force type tension (stretching)

14.4.2 Bending

Bending forces occur as a result of loads being applied to vertical floor slabs and beams. Bending forces can also occur in roof rafters and sloped slabs.

Bending places tension on the beams, stretching them. This results in breakage.

Indications of bending forces are cracks that start to appear under the point at which the load is applied.

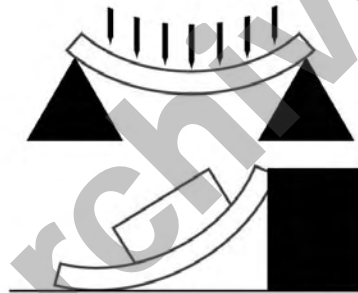

Figure 14:12
Force type bending (load)

14.4.3 Shear

Shear stress can be described as the tendency to tear the beam's surfaces apart. An example of shear stress is a wall becoming out of square. The face of the wall has extreme pressure applied and shear stress may tear materials apart.

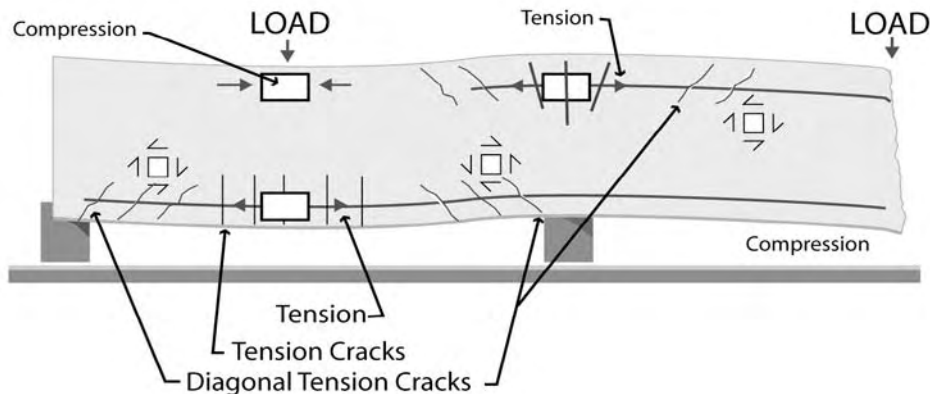

Figure 14:13
Force type shear (tearing)

When excessive stresses and loads are exerted on a structure, as can occur during an explosion or cyclone, the structure may be more susceptible to collapse.

Factors that can also contribute to the collapse of a structure include:

- the quality of the work
- the age of the structure
- alterations and modifications made, and
- inferior or faulty materials used in the construction.

14.4.4 Compression

Compression occurs when materials are loaded and have a large weight exerted on them. The weight can crush the materials, split concrete or timber, and buckle long, slender members by bowing.

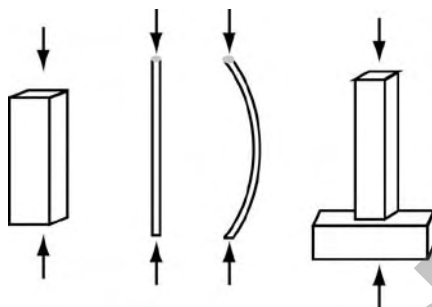

Figure 14:14
Force type compression (crushing)

An awareness of the types of stresses and loads that act on a structure and the factors that can contribute to a structure collapse can help rescuers determine the cause of a collapse.

14.5 Structural Instability and Secondary Collapse

When structures are subjected to forces that may cause instability or collapse, rescuers must be aware that, after the initial collapse, structures can continue to deteriorate and secondary collapse or total collapse may occur.

Any area on the structure collapse site that appears unsafe, or could be subject to further collapse, must be marked as a 'No Go' area.

'No Go' areas may include standing walls that are unstable and could collapse. Rescuers need to be able to identify areas that a collapsed wall could cover if further collapse occurs.

Allow one and a half times the height of the wall for a vertical collapse area to allow for heavy masonry or beams that will be thrown further upon impact with the ground.

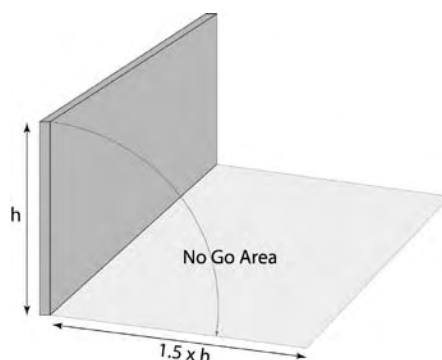

Figure 14:15
Collapse zone

14.6 Collapse Patterns and Potential Voids

It is important for rescuers to recognise the various types of collapse patterns that may have created voids where victims may be located.

This, coupled with information obtained from witnesses, will assist rescuers in determining search priorities.

There are several types of structure collapse patterns, including:

- a. curtain fall wall
- b. inward/outward
- c. lean-over
- d. lean-to floor
- e. 90 degree angle wall
- f. pancake floor
- g. inverted, 'A' or tent
- h. 'V'
- i. cantilever, and
- j. progressive.

USAR Category 1 response personnel should note that it will be common for a combination of these collapse patterns to occur at any structure collapse incident, and that specialist USAR personnel and equipment may be required to effect rescue.

14.6.1 Curtain Fall Wall Collapse

Curtain fall wall collapse occurs when a wall constructed of bricks or blocks falls like a curtain (that is, drops straight downward).

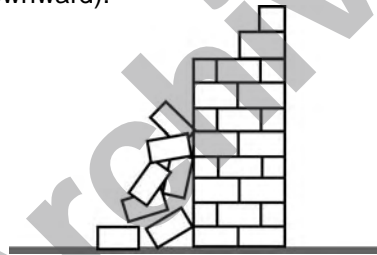

Figure 14:16
Curtain fall wall collapse

14.6.2 Inwards/Outward Collapse

Inwards/outwards collapse occurs when a wall made of bricks or blocks falls with the top portion of the wall falling inwards and the bottom portion of the wall falling outwards.

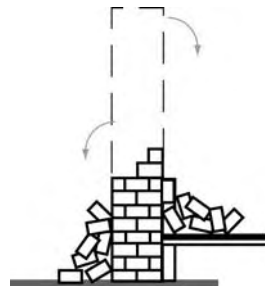

Figure 14:17
Inward/outward collapse

14.6.3 Lean-over Collapse

Lean-over collapse occurs when a wooden frame building collapses to one side. Voids are created by roof spaces and other structural members. USAR Category 1 operators must mark these voids as a search priority for USAR Category 2 operators if trapped victims are identified.

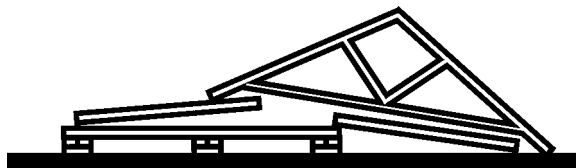

Figure 14:18
Lean over collapse

14.6.4 Lean-to Floor Collapse

Lean-to floor collapse occurs when a floor above ground level becomes dislodged from one side of the structure and falls to the level below, creating a triangle-shaped void.

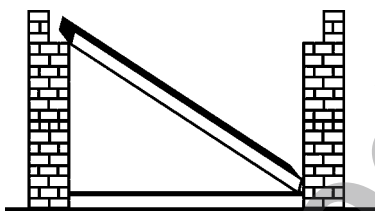

Figure 14:19
Lean-to floor collapse

14.6.5 90 Degree Angle Wall Collapse

90 degree angle wall collapse occurs when a wall made of masonry, bricks or blocks collapses at a 90 degree angle, covering the ground with the wall for a distance of the height of the wall.



Figure 14:20
90 degree angle wall collapse

If the wall falls onto other objects and maintains its integrity, voids may be created under the wall.



Figure 14:21
An example of a 90 degree angle wall collapse

14.6.6 Pancake Floor Collapse

Pancake floor collapse occurs when a floor or ceiling falls downwards. Small voids are created by strong supporting objects between the floors. Many individual voids can be created.

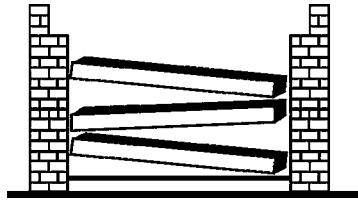

Figure 14:22

Pancake floor collapse

14.6.7 Inverted, 'A' or Tent Collapse

Inverted, 'A' or tent collapse occurs when the floor or ceiling gives way at the walls and falls to the floor below. This results in the opposite of the 'V' type collapse pattern and creates a void in the middle.

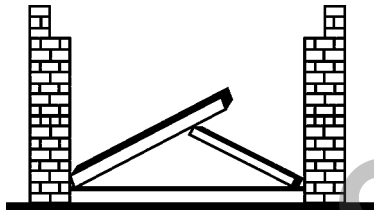

Figure 14:23

Inverted, 'A' or tent collapse

14.6.8 'V' Collapse

'V' collapse occurs when the floor or ceiling gives way in the centre and falls to the floor below. Voids are created at either end.

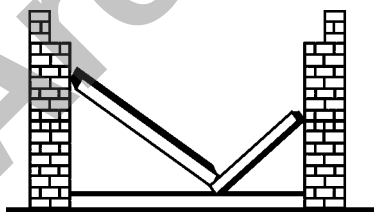

Figure 14:24

'V' collapse

14.6.9 Cantilever Collapse

Cantilever collapse occurs when a piece of floor, ceiling or wall falls, landing on a stationary structure and leaving a large segment hanging over an open area. Voids are created under the floor, ceiling or walls that fell on a stationary structure.



Figure 14:25

Cantilever collapse

14.6.10 Progressive Collapse

Progressive collapse occurs when there is an initial failure of a single primary support member and a chain reaction of failures continues in a downward movement. Many small voids are created.

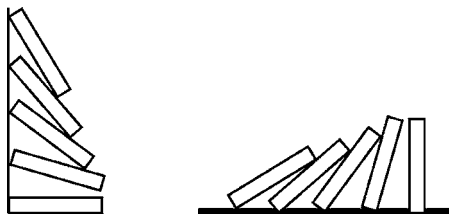

Figure 14:26
Progressive collapse

14.7 Precautions in Operations

In the interest of safety to both the trapped casualties and the rescuers, make a thorough appreciation before any rescue operation begins. The main safety considerations are as follows:

- a. Do not move any debris in contact with the collapse without assessing its importance to the stability of the site.
- b. Always stabilise a collapse with shoring before entering a void.
- c. Ensure entry and rescue procedures for confined spaces comply with the provisions of AS/NZS 2865:2001.
- d. Always appreciate the forces and their possible direction of movement in all types of collapse.
- e. Pack and support vertically, horizontally and laterally whenever and wherever possible.
- f. In all materials used, consider their strength in relation to the loads to which they will be subjected.
- g. Any disaster will invariably result in ruptured electrical, water, gas and sewer lines and, although these will be primarily the responsibility of the public utility, it is essential that rescue personnel be trained to deal with such problems in the initial stages.

14.8 Crush Injuries

Remember that casualties may be found who have suffered severe crush injuries. These people will be suffering from shock and their breathing passages may be clogged by the dust contained in the debris. Take immediate steps to provide a clear airway for such casualties.

People trapped in debris and suffering from crush injuries need rapid and expert medical attention. Treat these victims, if possible, before release from entrapment.

14.9 Debris Clearance

Two methods to extract people trapped under a pile of debris are:

- a. clearance of debris (that is, by removing the debris piece by piece until the casualties are uncovered and freed), and
- b. the construction of tunnels and linking of voids.

If anyone survives at all inside or under a large pile of debris after a building has collapsed, it is because some heavy timber, a floor or other portion of the structure, has fallen or remained fixed in such a way as to protect this person from the main impact and weight of the debris. Furniture can sometimes protect a casualty. Unless something of this kind has happened, it is unlikely that the casualty will survive. This protection may be of a very unstable nature. Exercise great care or it may collapse.

Disturb the debris as little as possible during rescue operations to avoid internal collapse and make sure that, as one portion of the debris is removed, the remainder is not dislodged and allowed to slide or fall.

Careful observance of these principles reduces the risk of further injury to trapped people, resulting in greater speed in the rescue operation. The ideal is speed with safety.

14.9.1 When Debris Clearance is Necessary

If no information is available regarding the approximate position of people trapped in debris, rescue can usually be affected only by total debris clearance. The essential difference between debris clearance as a rescue operation and debris clearance to clear a site is that, so long as there is a reasonable chance of recovering casualties by debris clearance, the rescue teams must proceed with unremitting effort. Rescue services must continue at work until it is certain that any people still buried are no longer alive, and the responsible officer, according to local arrangements, decides that operations can be discontinued.

14.9.2 Methods of Debris Clearance

When debris clearance is undertaken for rescue purposes, move the debris clear of the demolished building, not merely from one part of the site to another. Remove debris by hand or use receptacles found on the site. In a confined space or over obstacles, it is best to form a human chain. It may sometimes be necessary when clearing debris to cut a lane through it to reach a casualty. Take great care in so doing to ensure that the sides of the lane do not collapse. Make these safe, where necessary, with a simple form of timbering and strutting.

14.9.3 Precautions in Operations

Observe the following precautions:

- a. Identify suitable escape paths and keep them clear.
- b. Maintain a dynamic risk assessment and appoint a safety officer.
- c. Exercise care in the use of edged tools in debris clearance.
- d. Remove debris close to casualties by hand.
- e. Wear gloves.
- f. Do not climb over debris during the clearing operation unless absolutely necessary.
- g. Withdraw debris only when it is certain that no further collapse will be caused.
- h. Operate heavy equipment only at the direction of the officer in charge.
- i. Carefully coordinate movement of major debris elements.

14.10 Debris Tunnelling

Tunnelling is slow and dangerous work. Undertake it only after all other methods of reaching casualties have been exploited. It is used primarily for connecting existing voids. Tunnelling should be carried out from the lowest possible level, should not be used for general search and must not be aimless. Tunnelling may be used to reach a point, such as a void under a floor where a further search is to be conducted (Figure 14:27).

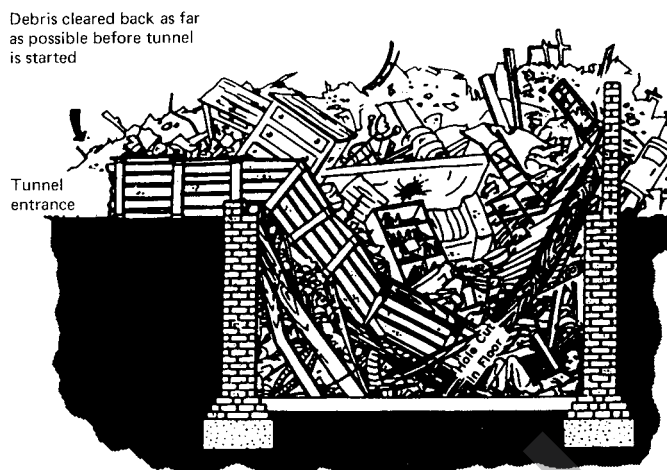

Figure 14:27
Tunnelling

14.10.1 Tunnel Sizes and Precautions

A tunnel must be of sufficient size to permit rescuers to bring out casualties. Do not construct a tunnel with abrupt turns. Tunnels as small as 750 mm wide and 900 mm high have proved satisfactory for rescue work. Wherever possible, drive tunnels along a wall or between a wall and a concrete floor to simplify the framing required.

Constructing a vertical shaft may be considered a form of tunnelling. Usually these shafts are made through earth after debris has been cleared from the surface and are used to reach a point where a basement wall can be breached. Exercise care not to sink shafts where water or gas service lines enter buildings. Avoid strata of soil or gravel carrying water.

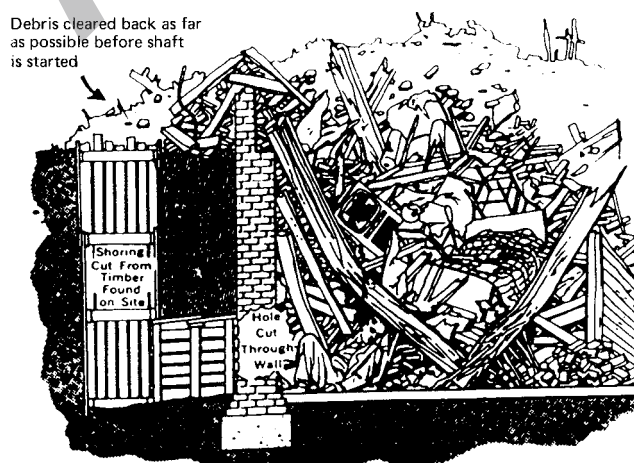

Figure 14:28
Tunnelling—external shaft

Debris tunnelling is quite different from tunnelling undisturbed earth, although strutting and bracing are necessary in both methods. The speed at which a debris tunnel can be constructed varies with the nature of the debris and the size and shape required because debris is unstable and key beams have to be left in place. The shape and path of a tunnel through debris is often irregular. Thus, a definite pattern of timbering, as in a tunnel through earth, is not possible. The nature of the job and the materials found on site or available from other sources govern the size of timbers used for bracing. It is always better to use timbers that are too heavy, rather than too light.

In debris tunnelling, keep constant watch for key timbers, beams and girders, disturbance of which could cause movement of the pile and collapse of the tunnel. To avoid any accidental movement, secure horizontal pieces by a prop placed under them, which still allows passage of both rescuers and stretchers. It may be difficult to recognise these key pieces, so brace everything in the tunnel as the work proceeds to help prevent accidents. Time spent in careful bracing will not be wasted when compared to the time required to reconstruct a collapsed tunnel.

14.10.2 Timbering and Lining Tunnels

The recommended method for constructing a debris tunnel is to use frames and forepoling. Frames are the primary supporting elements of the tunnel. Prefabricate them outside the tunnel and assemble them in position as the work progresses. Forepoling is the use of planks or boards driven between the collar and crownbar of one frame and extending beyond the next frame into the debris. Figure 14:29 shows a longitudinal section and a cross section of a frame tunnel using the forepole method.

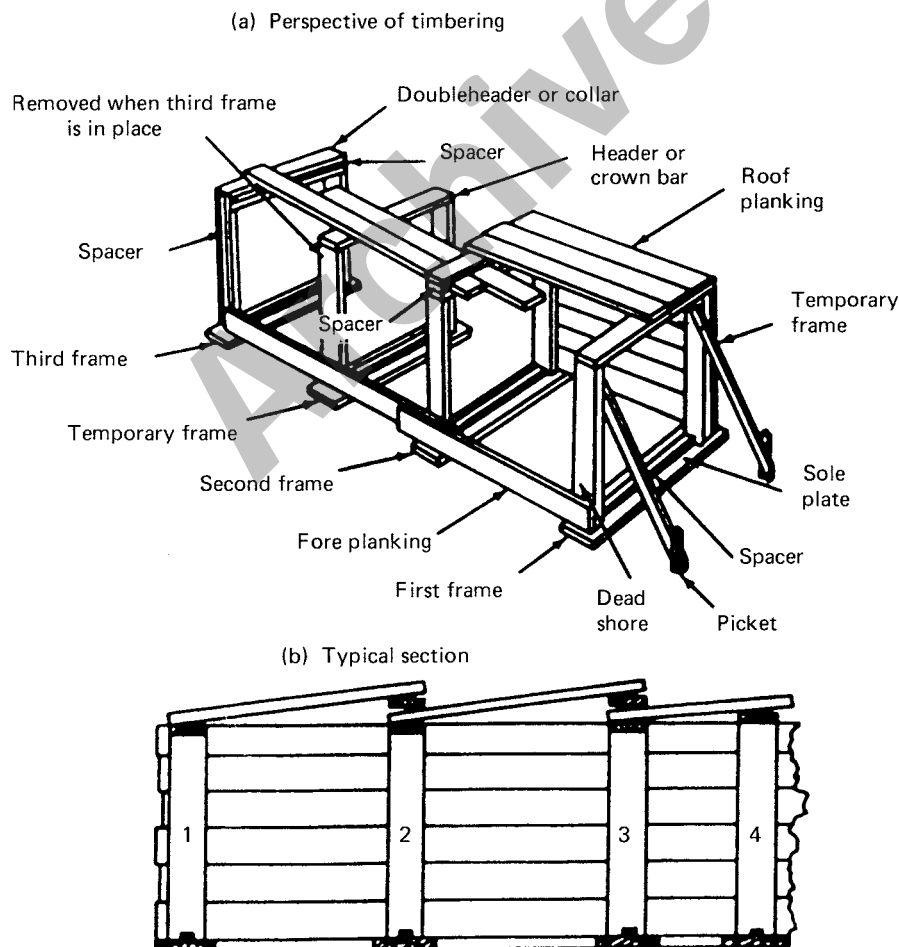

Note: 1, 2 and 3 are permanent frames, 4 is a temporary frame.

Figure 14:29
Timbering and lining tunnels

To start the tunnel, construct three frames. The first frame does not require a collar or spacer blocks at the top, nor do any of the temporary frames. The second and third frames and all other permanent frames in the tunnel require 50 mm spacer blocks and a collar piece set on top of the crownbar. First, set frame No. 3 against a cleared vertical face of debris and then place frame Nos 2 and 1 next, at approximately 1 m intervals and brace solidly. Diagonally brace frame No. 1 to stakes driven solidly into the ground, about 600–1000 mm in front of each strut. After the frames are in place, cover the top from frame 1 to frame 3 with long pieces of timber such as floor joists, roofing or flooring. (Beyond frame No. 3, forepoles need to be long enough to overlap only from one frame to the next.)

Line the sides in the same manner as the roof of the tunnel, driving boards between the frame struts and the rubble. To ensure stability of the tunnel thus far completed, pile debris against the sides and over the top. When completed, the frames should be completely covered, with the exception of the first frame and diagonal braces.

When debris is removed about 600 mm beyond the third frame, the load on the forepoles may make it necessary to construct a temporary frame, firmly wedged under them, until enough debris is removed to permit construction of a permanent frame. Remove the temporary frame after the permanent frame is properly braced and lined. Repeat this procedure until the tunnel is completed.

Usually, the debris of a demolished structure includes small rubble and dust, which will tend to trickle through gaps in the timbering. At first this may not seem important, but the escape of this material in quantity may disturb the mass of debris, causing internal movement. Therefore, board a tunnel through small loose debris as closely as possible.

Rectangular framing has certain disadvantages in debris tunnelling. Since frames are not rigid, unbalanced side pressures may cause them to collapse. In some instances, short debris tunnels with small cross sections may be driven in the form of a closed triangle, using heavy planks keyed together at the ends (Figure 14:30). Regardless of the method used, the strutting or lining must be rigid and as tightly wedged as possible. Rigidity and wedging keep the lining in position and prevent it from being broken by the impact of shifting or moving debris.



Figure 14:30
Different shapes of tunnels

When there is doubt regarding the quickest means of access, try two or more methods simultaneously (for example, a basement may be reached by one or more tunnels or by a shaft from the outside, all being attempted at the same time). Rescue teams may have to remove people from under collapsed basement walls or from basements still intact but with exits closed by debris (Figure 14:31). The leader may consider several different approaches.

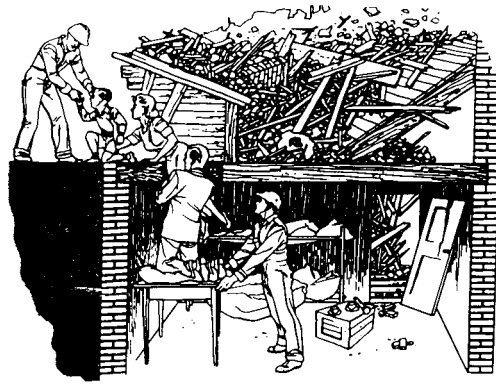

Figure 14:31
Basement access tunnel

14.11 Lifelines

Wear self-contained breathing apparatus and lifelines when entering tunnels which are contaminated, or thought to be contaminated, with toxic gases or which are deficient in oxygen. While wearing breathing apparatus, adhere to standard operational procedures. All rescuers involved in tunnelling operations must wear lifelines and all on site must agree to a signal system. Entry into any space with suspect air quality must be monitored with a four-head gas detector.

14.11.1 Lifeline Signals

The standard lifeline signals are:

- a. one pull—stop (if travelling), OK (if at rest)
- b. two pulls—advance
- c. three pulls—retreat, come out at once (from the outside), and
- d. continuous pulls—distress, need help.

14.12 Trenching

Frequently, an open trench can be completed more quickly than a tunnel, if debris is not piled too high (Figure 14:32). Trenching and tunnelling operations may sometimes be combined, with a trench extending into the debris until a tunnel becomes more practical. Trenching can be dangerous. If a trench collapses, the rescuer has little chance to avoid injury. Shore all trenches deeper than 1 m. Safety precautions for trenching are the same as for tunnelling.

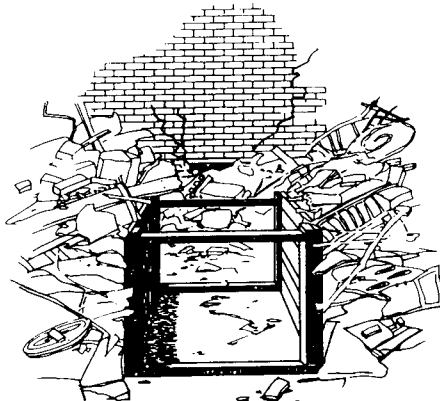

Figure 14:32
Trench shoring

14.13 Breaching Walls

Many different types of wall construction will be encountered in rescue operations. These include walls made of brick with mortar, stone, concrete, reinforced concrete and concrete block. When cutting through walls, be sure that support beams and columns are not weakened. After a building has been subjected to a blast or similar stresses, parts of the building left standing may appear sound, although badly shaken and cracked. Therefore, when cutting or hammering away wall sections, take care to prevent further collapse.

Openings large enough for rescue purposes can usually be made in brick walls, without masonry falling. Remove the bricks so that the opening is arch-shaped.

Concrete walls and floors, especially when they are reinforced, are difficult to cut through. Jack-hammers or other power tools may be necessary. Contact the local authority or utility services in this regard. With all walls and floors, except concrete, the best method is to cut a small hole and then enlarge it. With concrete, however, it is better to cut around the edge of the section to be removed. If the concrete is reinforced, the reinforcing bars can then be cut by hacksaw, torch or bolt cutters and the material removed in one piece. If an oxy-acetylene torch is used, be sure explosive gases are not present and that flammable materials are not ignited. Keep a fire extinguisher nearby. The use of any petrol-driven engine in or around the collapse environment can inject deadly levels of carbon monoxide into a void. It may be necessary to provide fan-forced ventilation to remove the gases.

Archived

Archived

CHAPTER 15

TEMPORARY SHORING AND ELEMENTARY DEMOLITION

15.1 Temporary Shoring

A temporary shore is a series of timbers and other materials erected to strengthen, and prevent further collapse of, any part of a building or structure. It is normal to limit any shoring undertaken by rescue teams to that required to:

- a. enable emergency personnel to carry out their duties with safety
- b. prevent further injury to casualties, and
- c. obviate danger to the public through the collapse of the building into a roadway or other public place.

15.1.1 Materials

Generally, the materials for temporary shoring are obtained from damaged buildings. Most buildings contain timbers of suitable sizes, especially if two or more pieces are nailed together to form the required lengths and cross-sections. Always do such making up with the timbers laminated or spiked together and with the joints staggered.

Do not spend time in erecting elaborate shoring at incidents. Erect only such temporary shoring as is necessary to meet urgent requirements.

Use Acrow props (Figure 15:1) or extension tubes fitted to hydraulic rams if available.

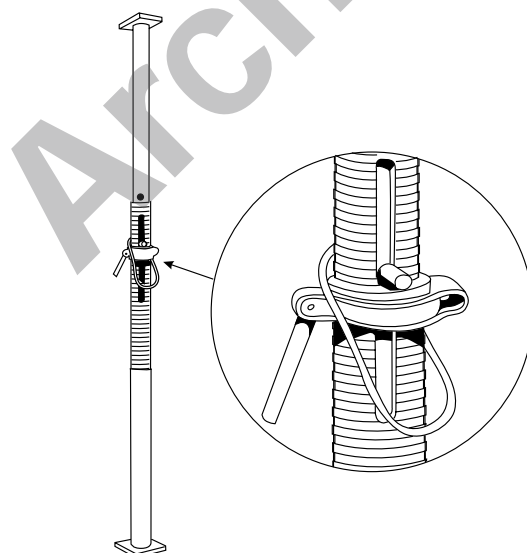

Figure 15:1

Acrow prop and pin placement

The purpose of shoring is to prevent further movement, not to force the damaged wall or ceiling back into its original position.

Any attempt at force may result in further damage. It is, however, essential to secure all shoring into its position. Do this gradually and without shock to the structure, use the lever and wedge methods rather than by hammering into position.

15.2 Folding Wedges

Gently secure the main shoring timbers into position. By far the best method is to use 'folding' or 'opposing' wedges. Form the wedges from timber found on site. When two wedges are placed in opposition, the grain of the timber should run along each of the contacting faces rather than meeting as end grains (Figure 15:2).

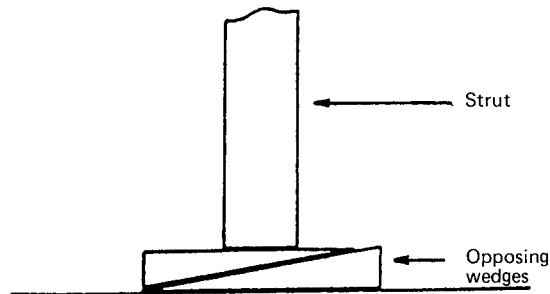

Figure 15:2
Folding wedges used to tension a dead shore

15.3 Types of Shore

The three main categories of shore are:

- a. raker-style shores
 - raker
 - multiple raker shore
 - split brace shore
 - flying raker shore
- b. flying shore (horizontal), and
- c. vertical shore (dead shore).

15.4 Raking Shore

Use a raking shore to prevent a wall or vertical part of a building from bulging or falling away (Figure 15:3).

15.4.1 Principal Parts

The principal parts are the raker, wall plate and sole piece or sole plate. Other items necessary for the erection of a raking shore are cleats, struts (or braces) and wedges. Recommended sizes are given below:

Max. Height (m)	Raker (mm)	Wall plate (mm)	Sole plate (mm)	Strut (mm)
4.5	100 x 100	240 x 50	240 x 75	100 x 50
6.0	125 x 125	240 x 75	240 x 75	100 x 50
7.5	150 x 150	240 x 75	240 x 75	150 x 100

Note: These can be either of solid timber, size as stated, or can be made up by laminating timbers, that is two 100 mm x 50 mm joists strapped and dogged together would form a 100 mm x 100 mm raker.

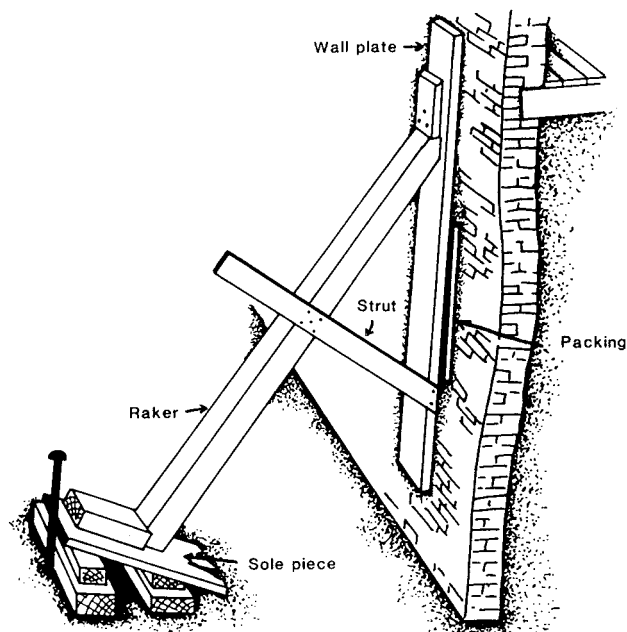

Figure 15:3

Raking shore with sole piece for hard ground

15.4.2 Method of Erection

a. Wall plate

Where possible the wall plate should be continuous throughout its length. When used against a bulging wall, back it with timber pieces in order to give it continuous bearing throughout its length. Prior to erection, nail a cleat to the wall plate where it meets the head of the raker (Figure 15:4). Secure the wall plate to prevent it from sliding upward as the raker is tightened into place. Once the cleat is nailed in position, hold the wall plate against the wall while the raker is fixed.

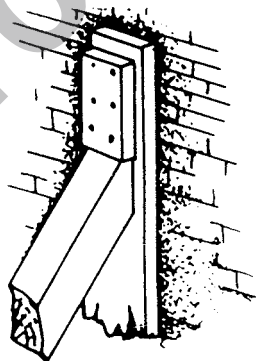

Figure 15:4

Head of raking shore

b. Raker and sole piece

- i) Place the sole piece so that it takes the thrust of the raker at an angle exceeding a right angle, so that when the raker is tightened up, a right angle is formed. Never do this tightening up with a hammer. Cut a small rebate from the foot of the raker to enable a lever to be inserted for tightening up (Figure 15:5). As an option, insert folding wedges between the foot of the raker and a cleat on the sole piece (Figure 15:6).

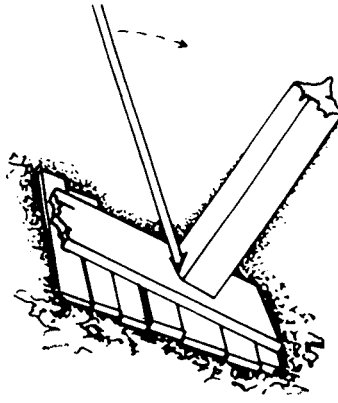

Figure 15:5
Levering raker into position

- ii) Soft ground can be excavated sloping towards the unsafe wall, in order to give the necessary angle. On hard ground, build up the sole piece to the required angle and spike or wedge it to prevent movement outwards. Alternatively, use a plank as wide as the wall plate to construct a sole plate. When the bottom of the wall plate is touching the ground, it could be allowed to rest on the end of the sole plate nearest the wall. Later, nail a cleat into position in the right angle thus formed.
- iii) Nail this cleat on to the sole plate approximately 50 mm away from the foot of the raker to allow for the insertion of folding wedges between the cleat and the raker. When the wedges are placed in position and tightened, exercise care to ensure that this action does not allow the wall plate to ride up the wall. As a safety measure, secure the end of the sole plate outside the raker with a stake or spike to prevent movement.

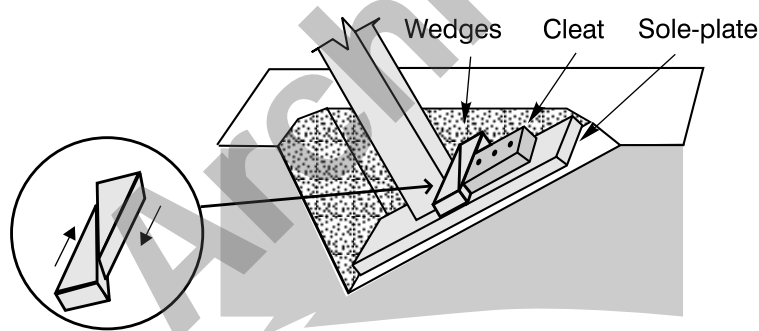

Figure 15:6
Use of opposing wedges to tension raker into position

c. **Strut (or brace)**

Then fix the strut. This prevents any movement by the foot of the wall plate and stops the wall plate from riding up the wall under stress. Spike the strut, and if necessary 'dog' it to the raker and wall plate.

d. **General**

Take care when setting out to ensure that the centre line of the raker and the centre line of any load-bearing joists meet at a common point. To prevent the wall plate from riding up the wall, use windowsills, oversailing courses or spikes placed in ventilator bricks. The best angle to achieve when locating the raker is 30 degrees at the head and 60 degrees at the foot.

15.4.3 Variations to Raker Shore

a. Raker shore

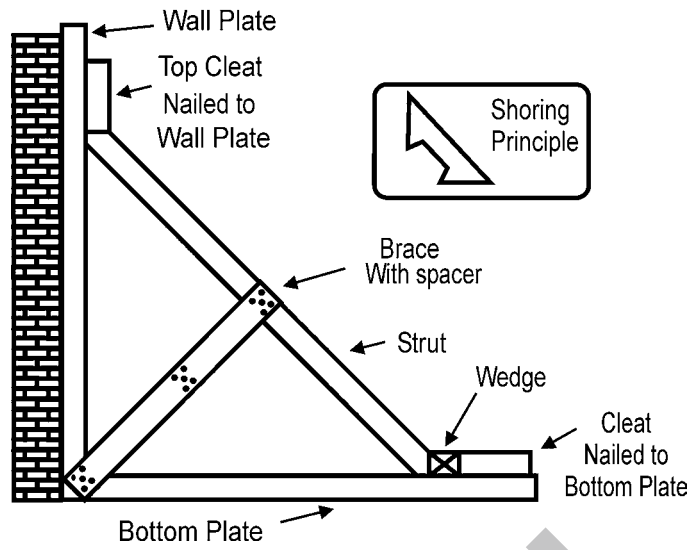

Figure 15:7
Raker shore

b. Multiple raker shore

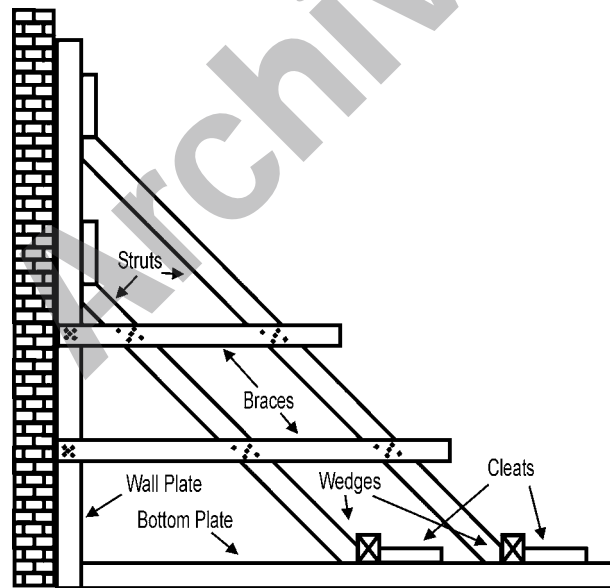

Figure 15:8
Multiple raker shore

The multiple raker shore can be used where a high wall is to be supported, with the wall plate having extra struts to support and transfer the load to the bottom plate.

c. **Split brace shore**

This variation on the raker shore can be used where a debris pile prevents the use of a bottom plate.

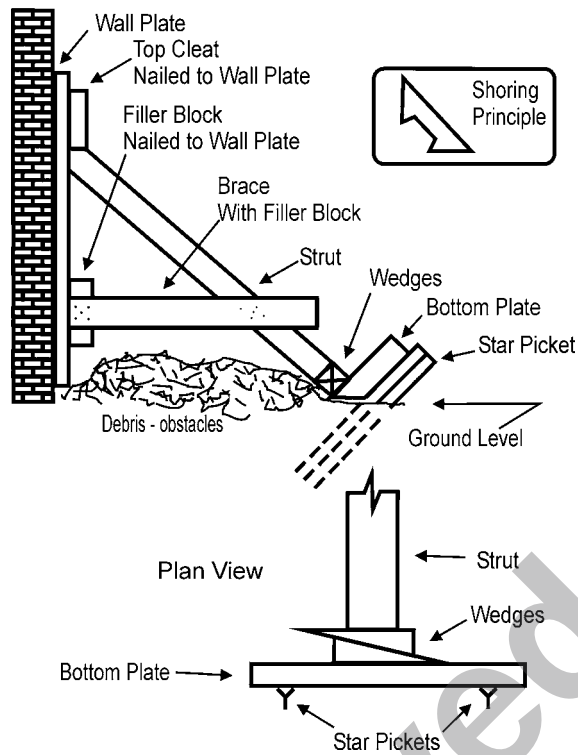

Figure 15:9
Split brace shore

d. **Flying raker shore**

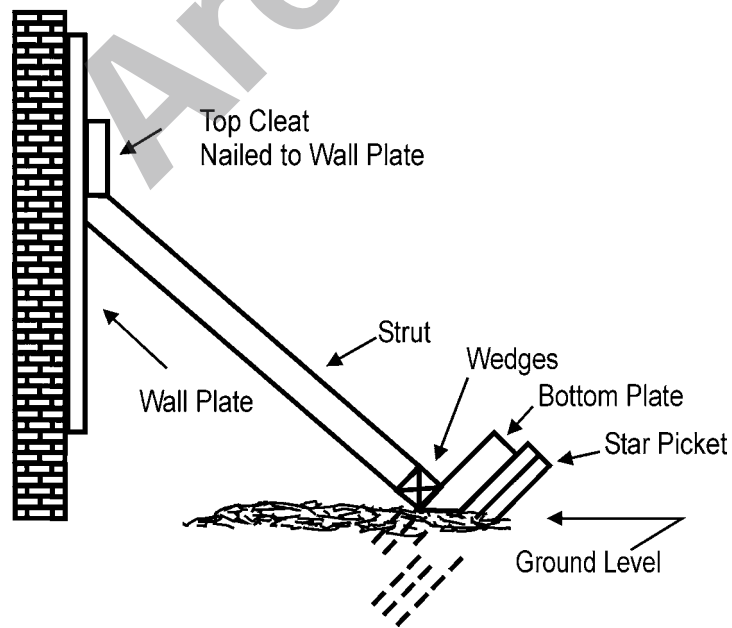

Figure 15:10
Flying raker shore

The flying raker shore is an easy and quick shore to erect. It is to be used as a temporary shore where light loads are to be supported.

15.5 Flying Shore

Use a flying shore to brace a damaged wall when a sound adjacent wall can be used as a means of support.

15.5.1 Principal Parts

The principal parts of a flying shore are the horizontal beam, the wall plate and struts. Other items necessary for the erection of the flying shore are cleats, wedges and straining pieces. Suitable sizes are given below:

Max. span (m)	Horizontal beam (mm)	Wall plates (mm)	Struts (mm)
3.0	150 x 100	175 x 50	100 x 100
4.5	150 x 150	175 x 50	100 x 100
6.0	150 x 150	240 x 50	100 x 100

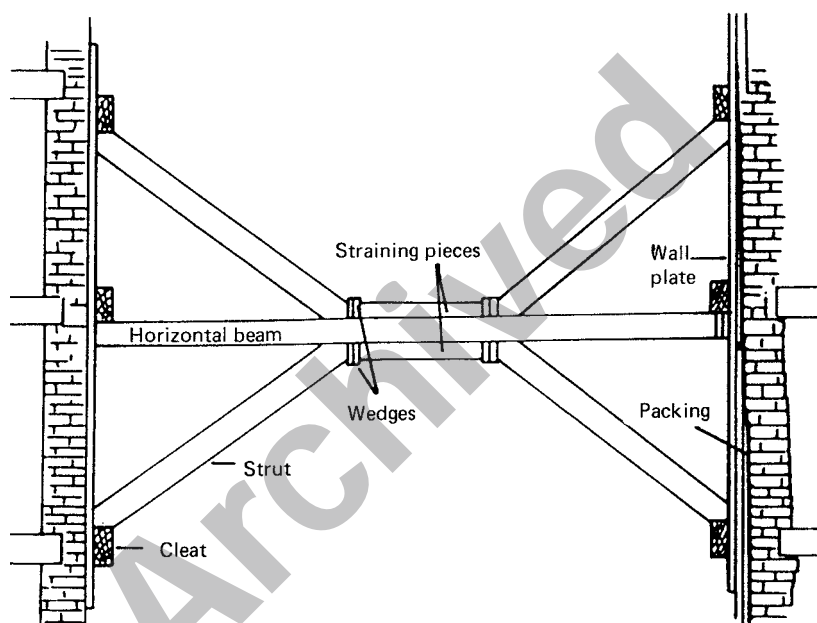

Figure 15:11
Flying shore

15.5.2 Method of Erection

Set the job out on the ground before erection, so that attention can be given to measurements and angles. Nail the cleats to their positions on the wall plates, the first pair to support the horizontal shore and the other pairs to support the struts. Ensure that the cleat for the horizontal beam adjacent to the sound wall is thick enough to allow for the folding wedges and a good overlap by the beam. Endeavour to give the horizontal beam equal cleat-bearing surface at each end. Set the struts at an angle not greater than 45 degrees to the horizontal beam, and keep them apart on the horizontal beam with straining pieces. The length of these straining pieces is determined by the length of the horizontal beam.

While the wall plates are being held in position, place the horizontal beam with the straining pieces temporarily lashed to it on the centre cleats and tighten it with folding wedges inserted between the shore and the wall plate. Next, place the struts into position between the cleats and the straining pieces being tightened by wedges. If wedges are necessary for the lower struts, place them between the tops of the lower cleats and the lower struts.

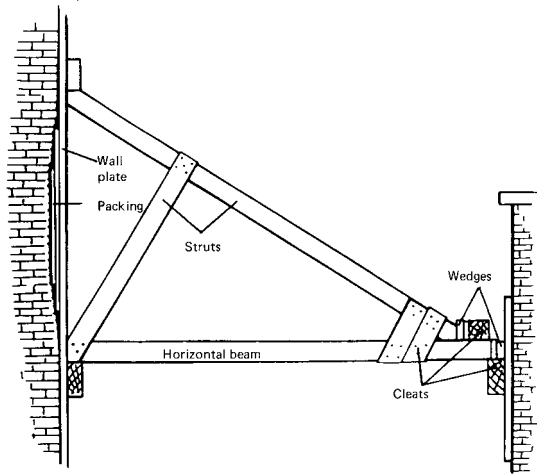

Figure 15:12
Flying shore

15.5.3 General

The centre line of the horizontal beam and struts should meet at a common point. The wall plates should be continuous throughout their lengths, and any gaps between the wall and the wall plate should be packed to provide a continuous load bearing against the wall. It is not advisable to erect a flying shore between two walls at a distance greater than 7.5 m apart. Place flying shores along a wall, at intervals of 2.5 m to 3.5 m, depending upon the circumstances and the degree of damage.

15.6 Dead Shore

A dead shore carries the vertical load of a wall or floor. Erect a dead shore when rescue personnel are working below a wall, ceiling or floor that is in danger of collapse. Make a careful assessment of the situation before work is commenced and, if in doubt, place dead shores in position as required. This type of operation is suited to the use of Acrow props.

15.6.1 Principal Parts

The principal parts of a dead shore are the sole piece, head piece and vertical shore. Other items used are braces, wedges and dogs.

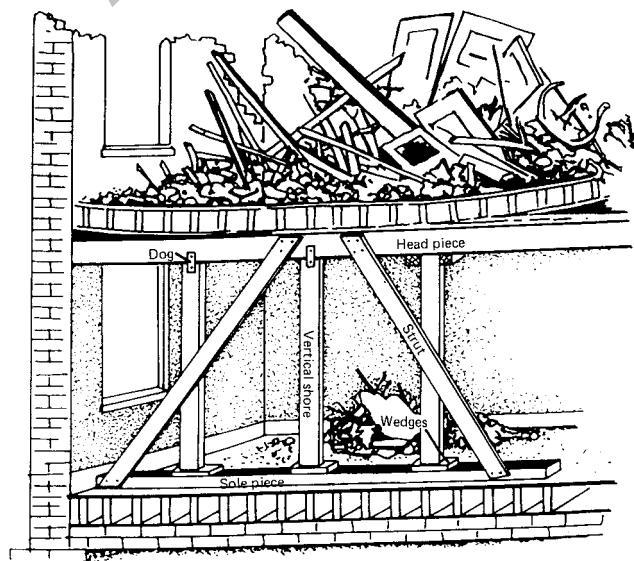

Figure 15:13
Dead shore

15.6.2 Method of Erection

Lay the sole piece down in position, taking care to place it on a solid foundation. Hold the head piece in position and then place the vertical shores upright between the head piece and the sole piece and securely wedge the vertical shores with pairs of folding wedges inserted between each shore and the sole piece. Tighten these wedges simultaneously. In using folding wedges, take care that the wedges are 'married' so that wedge tips overlap before tightening is attempted.

Where braces are necessary, ensure they are long enough to extend diagonally from the head piece across the vertical shore to the sole piece, and nail to each in turn.

15.6.3 General

Remember that dead shores may carry the full weight of the structure above, whereas raking and flying shores mainly oppose a threat of collapse. It is very important, therefore, to have a solid bearing for the sole piece. Ensure the sole piece is as broad and as long as possible in order to spread the load. There is no rule laid down as to how many verticals should be constructed: allow common sense to dictate this.

The double funnel principle demonstrates the ability of weight to be distributed from a solid bearing for the sole piece and head piece through the vertical shores.

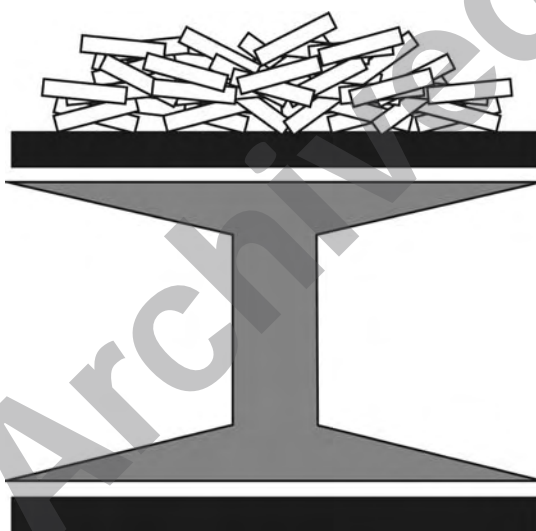

Figure 15:14

Double funnel principle

When selecting the vertical shores, remember that the length of each is the distance between the ceiling and floor, less the thickness of the head piece, the floor plate and about two thirds of the thickness of the wedges when folded. It is fairly difficult to estimate what load a vertical or dead shore will carry, but the following rules may help:

- a. The shorter the length, the greater the load-carrying capability.
- b. Stability is increased if the ends are cut square to fit on the head and the sole piece.
- c. Take care not to drive wedges too tightly or they will have a lifting effect.

15.7 Strutting of Openings

When the walls near window and door openings are unsafe and are to be shored up, or when the head or sides of such openings are damaged, it is a sensible precaution to strengthen the opening by strutting. Lever the uprights and struts into position or cut shorter and tighten with folding wedges. Use pairs of wedges. The size of timber usually used on this work varies from 100 mm x 50 mm to 175 mm x 75 mm, according to the size of the opening. If an arch has to be supported, shape or pack timbers to fit its entire underside, depending on the shape that the arch has assumed when damaged.

Many methods of strutting may be employed but, whether the opening is a window or a door, leave sufficient room between the struts for a casualty to be brought through or to enable a rescue to be effected.

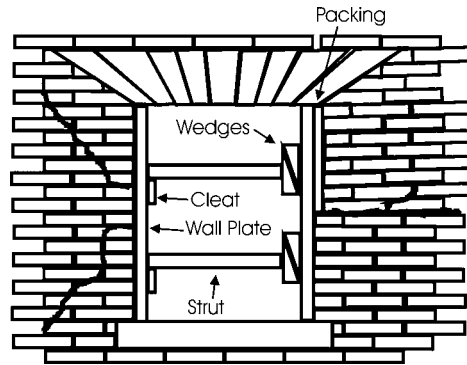

Figure 15:15
Strutting of openings

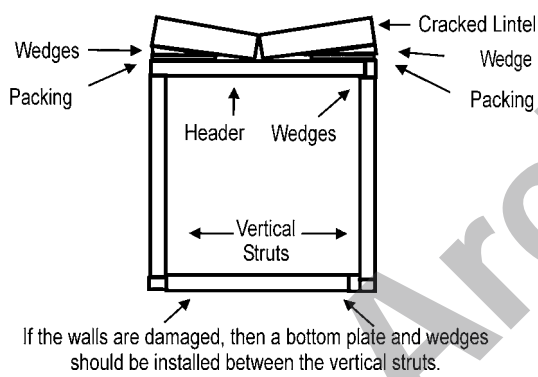

Figure 15:16
Door shore 1

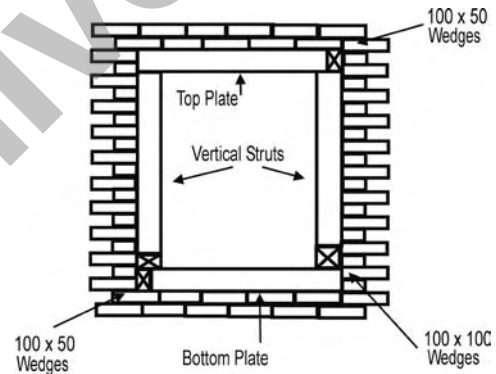

Figure 15:17
Door shore 2

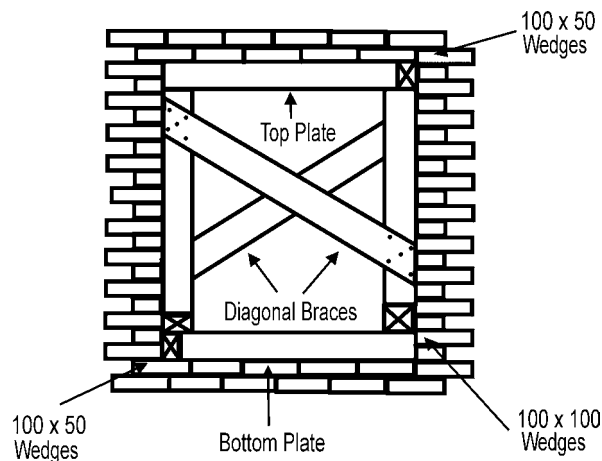

Figure 15:18
Diagonal bracing

15.8 Elementary Demolition

Demolition is a highly skilled operation rarely undertaken by rescue teams. Only elementary demolition of the most urgent nature is undertaken by rescue services when lives are in danger.

15.8.1 Available Methods

Two methods available to rescue teams are:

- a. piecemeal removal (that is, working down from the top), and
- b. pulling over by a cable attached to a vehicle or winch, or by a hauling team.

Adopt methods depending upon such factors as:

- a. degree of urgency
- b. space available, and
- c. stability of building.

Piecemeal demolition is the safest, but it takes longer. When using the cable method, pack out the noose to prevent cutting through a structure and to pull a section, not pieces, which may require to be undercut to fall in the desired position. Note that all demolition is likely to create additional dust.

Archived

Archived

LIST OF SHORTENED FORMS

AC	Alternating Current
AEM	Australian Emergency Manual
AMA	actual mechanical advantage
AS	Australian Standard
BCA	Building Code of Australia
BCF	Bromochlorodifluoromethane
CFA	Country Fire Authority
DCP	dry chemical powder
ELCB	Earth Leakage Circuit Breaker
INSARAG	International Search and Rescue Advisory Group
kg	kilogram
kW	kilowatts
m	metre
MBL	mean breaking load
mm	millimetre
NZS	New Zealand Standard
PTO	power take off
RCD	residual current device
SES NETC	State Emergency Service National Education and Training Committee
SF	safety factor
SOP	standard operating procedure
SWL	safe working load
SWR	steel wire rope
TMA	theoretical mechanical advantage
USAR	Urban Search and Rescue

GRAPHIC ACKNOWLEDGEMENTS

The NETC and EMA extend their appreciation and acknowledgement to the following organisations for permission to reproduce material from their publications.

Chapter reference	Figure reference	Source organisation	Publication
Chapter 1	1:1–1:17	Country Fire Authority - Victoria	USAR Category 1 Structure Collapse Rescue - October 2005
Chapter 3	3:1– 3:5	Australasian Fire Authorities Council	WER-009 Emergency Response Team Member - 2006
	Annex A	SAI Global	AS 2444-2001 Portable fire extinguishers and fire blankets – Selection and location
Chapter 4	4:4	New South Wales State Emergency Service	Vertical Rescue Learner Guide, 2003
	4:8	New South Wales State Emergency Service	General Rescue Learner Guide, 2004
Chapter 5	5:1–5:2, 5:4–5:6, 5:9, 5:11–5:15, 5:17–5:20, 5:23–5:27	New South Wales State Emergency Service	General Rescue Learner Guide, 2004
	5:22	New South Wales State Emergency Service	Storm and Water Damage Operations Learner Guide, 2004
Chapter 6	6:4–6:5, 6:7	New South Wales State Emergency Service	General Rescue Learner Guide, 2004
Chapter 7	7:2, 7:4–7:6, 7:9–7:11, 7:14–7:28, 7:30–7:35	New South Wales State Emergency Service	General Rescue Learner Guide, 2004
Chapter 8	8:3	New South Wales State Emergency Service	General Rescue Learner Guide, 2004
Chapter 9	9:1–9:2, 9:6, 9:10, 9:13	New South Wales State Emergency Service	General Rescue Learner Guide, 2004
	9:8	New South Wales State Emergency Service	Vertical Rescue Learner Guide, 2003
Chapter 10	10:3–10:6, 10:8, 10:10–10:12, 10:14–10:20, 10:25–10:27	New South Wales State Emergency Service	General Rescue Learner Guide, 2004
Chapter 11	11:10	New South Wales State Emergency Service	General Rescue Learner Guide, 2004
	11:15	New South Wales State Emergency Service	Road Crash Rescue Learner Guide
Chapter 14	14:1–14.26	Country Fire Authority - Victoria	USAR Category 1 Structure Collapse Rescue - October 2005
Chapter 15	15:7–15:10, 15:15–15:18	Victorian State Emergency Service	General Rescue Shoring and Cribbing Field Guide
	15:1, 15:6	New South Wales State Emergency Service	General Rescue Learner Guide, 2004

Archived