

# Australian Disaster Resilience Handbook Collection

This manual is no longer current. It has been archived. This manual will not be reviewed and should be used for historical reference only.

For further information please refer to AFAC Doctrine



Australian Institute for  
Disaster Resilience

**AUSTRALIAN EMERGENCY  
MANUALS SERIES**

**PART IV**

**Skills for Emergency Services Personnel**

**Manual 38**

**COMMUNICATIONS**

**Second Edition**

**EMERGENCY MANAGEMENT AUSTRALIA**

Archived

© Commonwealth of Australia 1998  
First edition 1991  
Second edition 1998

ISBN 0 642 47306 4

Edited and published by Emergency Management Australia  
Typeset by Defence Publishing Service, Department of Defence  
Printed in Australia by Paragon Printers, Canberra



**Australian Government**  
**Attorney-General's Department**  
**Emergency Management Australia**

**Copyright**

Permission to use the document and related graphics is granted provided that (1) the below copyright notice appears in all copies and that both the copyright notice and this permission notice appear, and (2) use of document and related graphics is for educational, informational and non-commercial or personal use only.

In all cases the Commonwealth of Australia must be acknowledged as the source when reproducing or quoting any part of this publication. Examples and quotations from other sources have been attributed to the original publication whenever possible and are believed to fall within fair use provisions, but these portions retain their copyright protection and must not be used without attribution.

Enquiries related to copyright should be addressed to:

The Director General  
Emergency Management Australia  
PO BOX 1020  
Dickson ACT 2602

Or telephone (02) 6256 4600 or fax (02) 6256 4653 or email [ema@ema.gov.au](mailto:ema@ema.gov.au)

Any rights not expressly granted herein are reserved.

**Disclaimer**

This publication is presented by Emergency Management Australia for the purpose of disseminating emergency management information free of charge to individuals who provide professional training and supervision to members of professional organisations in the field of emergency management. Professional organisations include but are not limited to, professional fire fighters, trained emergency services volunteers, and members of State/Territory police and rescue organisations whose members have training and basic competencies in emergency management services.

The information in this publication is not intended to be used by the general public or untrained persons, and is not a substitute for professional advice and /or training. Untrained persons should not use this publication unless a trained and qualified emergency management professional supervises them and/or their training in the subjects listed in the publication.

Emergency Management Australia in consultation with emergency management professionals and subject matter experts exercises care in the compilation and drafting of this publication, however, the document and related graphics could include technical inaccuracies or typographical errors and the information provided may not be appropriate to all situations. In no event shall the Commonwealth of Australia (acting through Emergency Management Australia) be liable for any damages whatsoever, whether in an action of contract, negligence or other tortious action, arising out of or in connection with the sue of or reliance on any of the information presented in this publication.

Emergency Management Australia periodically updates the information in this publication. Before using this publication please check with the Training Officer in the State Emergency Services organisation in your State/Territory to ensure that this edition is the most recent and updated version of the publication."

# THE AUSTRALIAN EMERGENCY MANUALS SERIES

The first publication in the original AEM Series of mainly skills reference manuals was produced in 1989. In August 1996, on advice from the National Emergency Management Principles and Practice Advisory Group, EMA agreed to expand the AEM Series to include a more comprehensive range of emergency management principles and practice reference publications. The Series is now structured in five parts as set out below.

Parts I to III are issued as bound booklets to State and Territory emergency management organisations and appropriate government departments for further dissemination to approved users including local government. Parts IV and V (skills and training management topics) are issued in loose-leaf (amendable) form to all relevant State agencies through each State and Territory Emergency Service who maintain State distribution/amendment registers. All private and commercial enquiries are referred to EMA as noted at the end of the Foreword on page vii.

## AUSTRALIAN EMERGENCY MANUALS SERIES STRUCTURE AND CONTENT

|  |  | Publishing<br>Status—Dec 98 |
|--|--|-----------------------------|
| <b>PART I—THE FUNDAMENTALS</b>                               |  |                             |
| Manual 1   | Emergency Management Concepts and Principles (3rd edn) | A/R                         |
| Manual 2   | Australian Emergency Management Arrangements (6th edn) | R                           |
| Manual 3   | Australian Emergency Management Glossary               | A                           |
| Manual 4   | Emergency Management Terms Thesaurus                   | A                           |
| <b>PART II—APPROACHES TO EMERGENCY MANAGEMENT</b>            |  |                             |
| <b>Volume 1—Risk Management</b>                              |  |                             |
| Manual 1   | Emergency Risk Management                              | D                           |
| <b>Volume 2—Risk Evaluation</b>                              |  |                             |
|  | Titles to be advised                                   | P                           |
| <b>Volume 3—Mitigation Planning</b>                          |  |                             |
|  | Titles to be advised (covering PPRR)                   | P                           |
| <b>Volume 4—Implementation of Emergency Management Plans</b> |  |                             |
|  | Titles to be advised                                   | P                           |
| <b>PART III—EMERGENCY MANAGEMENT PRACTICE</b>                |  |                             |
| <b>Volume 1—Service Provision</b>                            |  |                             |
| Manual 1   | Emergency Catering                                     | A                           |
| Manual 2   | Disaster Medicine                                      | A/R                         |
| Manual 3   | Disaster Recovery                                      | A/R                         |
| <b>Volume 2—Specific Issues</b>                              |  |                             |
| Manual 1   | Evacuation Planning                                    | D                           |
| Manual   | Flood Plain Management                                 | D                           |
| Manual   | Flood Preparedness                                     | D                           |
| Manual   | Flood Warning  | A/R                         |
| Manual   | Flood Response Operations                              | D                           |
| Manual   | Civil Defence  | D                           |
| Manual   | Community Emergency Planning (3rd edn)                 | A/R                         |
| Manual   | Urban Search and Rescue                                | D                           |

**AUSTRALIAN EMERGENCY MANUALS SERIES STRUCTURE AND CONTENT**

Publishing  
Status—Dec 98

**Volume 3—Guidelines**

|         |   |     |
|---------|---|-----|
| Guide 1 | Multi-Agency Incident Management        | A   |
| Guide 2 | Community and Personal Support Services | A D |
| Guide 3 | Safe and Healthy Mass-Gatherings        | A/R |
| Guide 4 | Disaster Victim Identification          |     |

**PART IV —SKILLS FOR EMERGENCY SERVICES PERSONNEL**

|           |   |     |
|-----------|---|-----|
| Manual 1  | Storm Damage Operations (2nd edn)                 | A   |
| Manual 2  | Operations Centre Management                      | A   |
| Manual 3  | Leadership  | A   |
| Manual 4  | Land Search Operations (2nd edn—Amdt 1)           | A   |
| Manual 5  | Road Accident Rescue (2nd edn)                    | A   |
| Manual 6  | General Rescue (4th edn—formerly Disaster Rescue) | A   |
| Manual 7  | Map Reading and Navigation (Amdt 1)               | A   |
| Manual 8  | Four-Wheel-Drive Vehicle Operation (Amdt 1)       | A   |
| Manual 9  | Communications (2nd edn)                          | A   |
| Manual 10 | Vertical Rescue (Amdt 1)                          | A/R |
| Manual    | Flood Rescue Boat Operation (2nd edn)             | A/R |
| Manual    | Chain Saw Operation                               | A/R |

**PART V —THE MANAGEMENT OF TRAINING**

|          |   |   |
|----------|---|---|
| Manual 1 | Small Group Training Management (2nd edn) | R |
| Manual 2 | Exercise Management                       | D |

---

**Key to status: A = Available; A/R = original version Available/under Review;  
D = under Development; P= Planned; R = under Review/Revision**



## FOREWORD

THE PURPOSE OF THIS MANUAL IS TO PROVIDE A BASIC REFERENCE FOR COMMUNICATIONS. IT IS INTENDED FOR USE IN PLANNING, TRAINING AND OPERATIONS BY ALL EMERGENCY SERVICES PERSONNEL.

THE MANUAL HAS BEEN DEVELOPED BY A NATIONAL CONSULTATIVE COMMITTEE REPRESENTING POLICE, FIRE AND STATE/TERRITORY EMERGENCY SERVICES. THIS COMMITTEE WAS INITIATED AND SPONSORED BY EMERGENCY MANAGEMENT AUSTRALIA.

THIS COMMUNICATIONS MANUAL IS PRESENTED IN THREE SECTIONS TO FACILITATE UNDERSTANDING AND TRAINING OF PERSONNEL AT INTRODUCTORY, INTERMEDIATE AND ADVANCED LEVELS.

SECTION ONE IS FOR ALL EMERGENCY SERVICES PERSONNEL; SECTION TWO IS FOR ALL EMERGENCY SERVICE PERSONNEL WHO HAVE A DAY-TO-DAY USER REQUIREMENT OR A NEED FOR AN IMPROVED KNOWLEDGE OF COMMUNICATIONS AND SECTION THREE IS DESIGNED FOR COMMUNICATIONS MANAGERS OR SENIOR STAFF. EACH SECTION MAY BE USED AS AN INDIVIDUAL DOCUMENT. HOWEVER, TO ALLOW NATURAL PROGRESSION, THE MANUAL SHOULD BE READ IN SEQUENCE.

THE MANUAL IS ISSUED IN LOOSE-LEAF FORM TO FACILITATE AMENDMENT AND INSERTION OF STATE AND TERRITORY SUPPLEMENTS.

PROPOSED CHANGES TO THE DOCUMENT SHOULD BE FORWARDED TO THE DIRECTOR-GENERAL, EMERGENCY MANAGEMENT AUSTRALIA, AT THE ADDRESS SHOWN BELOW, THROUGH THE RESPECTIVE STATE/TERRITORY EMERGENCY MANAGEMENT ORGANISATION.

THE PUBLICATION IS PROVIDED FREE OF CHARGE TO APPROVED AUSTRALIAN ORGANISATIONS. COPIES WILL BE ISSUED UPON REQUEST FROM APPROPRIATE USERS TO THEIR STATE/TERRITORY EMERGENCY SERVICE (HQ) WHO MAINTAIN DISTRIBUTION/AMENDMENT REGISTERS.

TO SUPPORT THE INTERNATIONAL DECADE FOR NATURAL DISASTER REDUCTION, THE AUSTRALIAN GOVERNMENT WILL ALLOW APPROVED OVERSEAS ORGANISATIONS TO REPRODUCE THIS PUBLICATION WITH ACKNOWLEDGMENT BUT WITHOUT PAYMENT OF COPYRIGHT FEES.

CONSIDERATION WILL BE GIVEN TO REQUESTS FROM DEVELOPING COUNTRIES FOR MULTIPLE COPIES WITHOUT CHARGE.

ENQUIRIES SHOULD BE SENT TO THE DIRECTOR-GENERAL, EMERGENCY MANAGEMENT AUSTRALIA, PO BOX 1020, DICKSON, ACT 1602, AUSTRALIA. (FACSIMILE: 61 (0) 2 62577665, E-MAIL:ema@ema.gov.au).



**Archived**

# CONTENTS

|   | <b>Page</b> |
|---|-------------|
| The Australian Emergency Manuals Series             | iii         |
| Amendment Certificate                               | v           |
| Foreword  | vi          |
| Contents  | viii        |
| Occupational Health and Safety Issues               | xvi         |
| Introduction  | xvii        |
|   | <b>Para</b> |
| <b>SECTION 1—COMMUNICATIONS SYSTEMS AND METHODS</b> |             |
| <b>CHAPTER 1 TELECOMMUNICATIONS NETWORKS</b>        |             |
| INTRODUCTION  | 1.1         |
| National Network                                    | 1.1         |
| Special Emergency and Disaster Services             | 1.2         |
| Telecommunication Network Features                  | 1.3         |
| TELEPHONE SYSTEMS                                   | 1.4         |
| Telephone Equipment                                 | 1.4         |
| Fixed Wire Telephone Network                        | 1.5         |
| Cellular (Mobile) Telephone Systems                 | 1.6         |
| Field Telephone Systems                             | 1.9         |
| FACSIMILE   | 1.10        |
| Description   | 1.10        |
| System  | 1.11        |
| Copy Life   | 1.12        |
| Advantages and Disadvantages                        | 1.13        |
| PAGERS  | 1.14        |
| Advantages and Disadvantages                        | 1.15        |
| SATELLITE COMMUNICATIONS                            | 1.16        |
| Long Range Communications                           | 1.16        |
| Concept   | 1.17        |
| Telephone Connection                                | 1.18        |
| Size  | 1.19        |
| Advantages and Disadvantages                        | 1.20        |
| PERSONAL COMPUTERS AND DATA TRANSMISSION            | 1.21        |
| Networks  | 1.22        |
| PC Advantages and Disadvantages                     | 1.23        |
| Computer-aided Dispatch                             | 1.24        |
| Data Communications                                 | 1.26        |
| Electronic Mail                                     | 1.29        |
| Internet  | 1.31        |
| World Wide Web                                      | 1.33        |
| <b>CHAPTER 2 OTHER COMMUNICATIONS METHODS</b>       |             |
| Courier Systems                                     | 2.1         |
| Visual/Audible Signals                              | 2.3         |
| Public Media  | 2.5         |

|                  |   |      |
|------------------|---|------|
| <b>CHAPTER 3</b> | <b>RADIO COMMUNICATION NETWORKS AND SYSTEMS</b>         |      |
|                  | RADIO NETWORKS  | 3.1  |
|                  | Features  | 3.1  |
|                  | Frequency bands   | 3.3  |
|                  | Advantages and disadvantages                            | 3.5  |
|                  | RADIO TRANSCEIVERS—GENERAL                              | 3.6  |
|                  | Base Station  | 3.7  |
|                  | Repeater Base Station                                   | 3.8  |
|                  | MOBILE RADIO TRANSCEIVERS                               | 3.10 |
|                  | Transceivers  | 3.10 |
|                  | Antennas  | 3.11 |
|                  | Interference  | 3.13 |
|                  | HAND-HELD PORTABLE RADIO TRANSCEIVER                    | 3.14 |
|                  | Portability   | 3.14 |
|                  | Size  | 3.15 |
|                  | Performance Enhancement                                 | 3.16 |
|                  | MANPACK PORTABLE RADIO TRANSCEIVERS                     | 3.17 |
|                  | Features  | 3.17 |
|                  | Uses  | 3.18 |
|                  | Battery Recharge  | 3.19 |
| <b>CHAPTER 4</b> | <b>COMMUNICATION EQUIPMENT OPERATION AND PROCEDURES</b> |      |
|                  | TELEPHONE PROCEDURES                                    | 4.1  |
|                  | Answering   | 4.1  |
|                  | Calling   | 4.2  |
|                  | Background Noise  | 4.3  |
|                  | RADIO COMMUNICATION PROCEDURES                          | 4.4  |
|                  | Basic Radio Operating Procedures                        | 4.4  |
|                  | Benefits of Standard Procedures                         | 4.5  |
|                  | User Factors  | 4.6  |
|                  | Prowords  | 4.7  |
|                  | Radio Call Signs  | 4.8  |
|                  | RADIO EQUIPMENT OPERATION                               | 4.9  |
|                  | Control Functions                                       | 4.9  |
|                  | Receiving Messages                                      | 4.10 |
|                  | Sending Messages  | 4.11 |
|                  | Transmit Timers   | 4.12 |
|                  | Transmission Principles                                 | 4.13 |
|                  | Phonetic Alphabet                                       | 4.14 |
|                  | Difficult Conditions/words                              | 4.16 |
|                  | Pronunciation of Figures                                | 4.17 |
|                  | Punctuation   | 4.18 |
|                  | Mixed Groups  | 4.19 |
|                  | Grid References   | 4.20 |
|                  | Radio Checks and Signal Reports                         | 4.21 |
|                  | Sensitive Message Traffic                               | 4.23 |
|                  | Exercise Traffic  | 4.24 |
|                  | RADIO NETWORKS  | 4.25 |
|                  | Radio Link  | 4.25 |
|                  | Radio Network   | 4.26 |

|                               |      |
|-------------------------------|------|
| Control Station               | 4.27 |
| RADIO OPERATING CONDITIONS    | 4.28 |
| Fading                        | 4.28 |
| Interference to Radio Signals | 4.29 |
| Manufactured Interference     | 4.30 |
| SUMMARY                       | 4.32 |

## SECTION 2—ESTABLISHMENT, MAINTENANCE AND OPERATION OF COMMUNICATION SYSTEMS AND EQUIPMENT

### CHAPTER 5 PUBLIC SWITCHED TELEPHONE NETWORK

|                                      |      |
|--------------------------------------|------|
| INTRODUCTION                         | 5.1  |
| EMERGENCY SERVICES LIAISON PERSONNEL | 5.2  |
| Trained Personnel                    | 5.2  |
| Specialised Facilities               | 5.3  |
| TELEPHONE EXCHANGES                  | 5.4  |
| General                              | 5.4  |
| Private Automatic Branch Exchange    | 5.5  |
| Alternative Facilities               | 5.6  |
| TELEPHONES                           | 5.7  |
| General                              | 5.7  |
| Special Telephone Features           | 5.8  |
| Group Alert Calling                  | 5.9  |
| Faxstream                            | 5.10 |
| Cellular Telephones                  | 5.13 |

### CHAPTER 6 OTHER SYSTEMS AND SERVICES

|  |      |
|--|------|
| MARITIME RADIO SERVICE                     | 6.1  |
| ROYAL FLYING DOCTOR SERVICE                | 6.2  |
| WIRELESS INSTITUTE CIVIL EMERGENCY NETWORK | 6.3  |
| CITIZENS BAND RADIO SERVICE                | 6.4  |
| Operator Discipline                        | 6.5  |
| SATELLITE COMMUNICATIONS                   | 6.6  |
| Services                                   | 6.7  |
| Footprint or Coverage                      | 6.8  |
| Orbits                                     | 6.9  |
| Low Earth Orbit Satellites                 | 6.11 |
| Medium Earth Orbit Satellites              | 6.12 |
| Future Directions                          | 6.13 |
| Navigation Satellite Systems               | 6.15 |

### CHAPTER 7 RADIO COMMUNICATIONS FUNDAMENTALS

|                          |     |
|--------------------------|-----|
| INTRODUCTION             | 7.1 |
| RADIO WAVES              | 7.2 |
| Description              | 7.2 |
| A Radio Wave             | 7.3 |
| Wave Length              | 7.4 |
| Frequency                | 7.5 |
| RADIO FREQUENCY SPECTRUM | 7.6 |
| Overlapping of Bands     | 7.7 |

|                   |  |      |
|-------------------|--|------|
| <b>CHAPTER 8</b>  | <b>RADIO TRANSMISSION PRINCIPLES, SYSTEMS AND EQUIPMENT</b>          |      |
|                   | INTRODUCTION   | 8.1  |
|                   | VERY HIGH FREQUENCY (VHF) AND ULTRA HIGH FREQUENCY (UHF) PROPAGATION | 8.2  |
|                   | Limitations  | 8.2  |
|                   | Dead Spots   | 8.4  |
|                   | Range  | 8.5  |
|                   | Emergency Services Use   | 8.6  |
|                   | Super High Frequency (SHF) Propagation                               | 8.7  |
|                   | VHF/UHF BASE STATIONS  | 8.8  |
|                   | Local Control  | 8.8  |
|                   | Remote Control   | 8.9  |
|                   | Simplex Operation  | 8.10 |
|                   | Repeater Base Stations   | 8.11 |
|                   | Portable Radio Base Station  | 8.13 |
|                   | Scanning   | 8.14 |
|                   | Disadvantage of Scanning   | 8.15 |
|                   | Telephone/Radio Interface  | 8.16 |
|                   | Trunked Radio Systems  | 8.17 |
| <b>CHAPTER 9</b>  | <b>HIGH FREQUENCY RADIO OPERATION</b>                                |      |
|                   | Complexities and Variables   | 9.1  |
|                   | High Frequency Propagation   | 9.2  |
|                   | Ground Wave  | 9.3  |
|                   | Sky Wave   | 9.4  |
|                   | Skip Zone  | 9.5  |
|                   | Selecting the Correct Frequency                                      | 9.6  |
|                   | Ionospheric Prediction Service (IPS)                                 | 9.7  |
|                   | HF BASE STATIONS   | 9.9  |
|                   | Local Control  | 9.9  |
|                   | Remote Control   | 9.10 |
|                   | Station Siting   | 9.12 |
|                   | HF MOBILE RADIO COMMUNICATIONS                                       | 9.13 |
|                   | Transceivers   | 9.13 |
|                   | Whip Antennas  | 9.14 |
|                   | Precautions  | 9.15 |
|                   | HF PORTABLE RADIO COMMUNICATIONS                                     | 9.16 |
|                   | Transceivers   | 9.16 |
|                   | OPERATING HF RADIOS  | 9.20 |
|                   | Basic Operating Steps  | 9.20 |
|                   | Modern HF Selective Calling (SELCALL) Systems                        | 9.21 |
|                   | HF Beacons   | 9.25 |
| <b>CHAPTER 10</b> | <b>BASIC RADIO MAINTENANCE</b>                                       |      |
|                   | OPERATOR MAINTENANCE   | 10.1 |
|                   | FAULT FINDING PROCEDURE  | 10.2 |
|                   | Total Failure  | 10.2 |
|                   | Receiver Failure   | 10.3 |
|                   | Transmitter Failure (Assuming the Radio is Receiving)                | 10.4 |
|                   | Fault Finding by Substitution  | 10.5 |

|                                    |       |
|------------------------------------|-------|
| RADIO BATTERIES—THEIR CARE AND USE | 10.6  |
| Dry Cells                          | 10.7  |
| Gel Cells                          | 10.9  |
| Nickel Cadmium Cells               | 10.12 |

## **CHAPTER 11 RADIO OPERATING PROCEDURES**

|   |       |
|---|-------|
| INTRODUCTION                                    | 11.1  |
| Prerequisite                                    | 11.2  |
| Radio Networks                                  | 11.3  |
| Network Discipline                              | 11.4  |
| TRAFFIC   | 11.5  |
| Formal Traffic                                  | 11.6  |
| Informal Traffic                                | 11.7  |
| CALLING AND ANSWERING                           | 11.8  |
| Introduction                                    | 11.8  |
| TYPES OF CALLS                                  | 11.9  |
| Single Call                                     | 11.9  |
| Multiple Call                                   | 11.10 |
| Net Call or All Stations Call                   | 11.11 |
| All Stations Except Call                        | 11.12 |
| ESTABLISHING A RADIO NET                        | 11.13 |
| Radio Check and Signal Strength Calls           | 11.13 |
| Initial Procedure                               | 11.14 |
| Radio Checks (Signal Strengths and Readability) | 11.15 |
| Report of Signal Strengths                      | 11.16 |
| Report of Readability                           | 11.17 |
| Examples of Transmissions to Establish the Net  | 11.18 |
| Signal Strength Reports                         | 11.19 |
| Signal Strength Report Form                     | 11.20 |
| Scheduled Calls                                 | 11.21 |
| TRANSMISSION OF INFORMATION                     | 11.22 |
| Prowords  | 11.22 |
| Unwritten Information                           | 11.23 |
| Written Information                             | 11.24 |
| Long Message Procedure                          | 11.25 |
| Example of Long Message                         | 11.26 |
| CORRECTIONS AND REPETITIONS                     | 11.27 |
| Prowords  | 11.27 |
| Correction During Transmission                  | 11.28 |
| Correction After a Message Has Been Sent        | 11.29 |
| Repetitions                                     | 11.30 |
| Speed of Transmission                           | 11.31 |
| Unknown Station                                 | 11.32 |
| VERIFICATIONS AND CANCELLATIONS                 | 11.33 |
| Prowords  | 11.33 |
| Verifications                                   | 11.34 |
| Cancelling Transmissions and Messages           | 11.35 |
| MISCELLANEOUS PROCEDURES                        | 11.36 |
| Prowords  | 11.36 |
| Arranging a Person to Person Conversation       | 11.37 |
| CHANGING FREQUENCY                              | 11.38 |

|                                     |       |
|-------------------------------------|-------|
| Prowords                            | 11.38 |
| Procedure                           | 11.39 |
| CLOSING DOWN                        | 11.40 |
| Prowords                            | 11.40 |
| Procedure                           | 11.41 |
| DIFFICULT WORKING CONDITIONS        | 11.43 |
| Causes                              | 11.43 |
| Procedures                          | 11.44 |
| Words Twice                         | 11.45 |
| Relay Procedure                     | 11.46 |
| Free and Directed Nets              | 11.47 |
| THE TRANSMISSION OF FORMAL MESSAGES | 11.48 |
| Offering                            | 11.48 |
| RADIO OPERATOR LOGS                 | 11.49 |
| Information                         | 11.50 |
| Format                              | 11.51 |
| DO'S AND DON'TS                     | 11.52 |

### **SECTION 3—EMERGENCY/DISASTER COMMUNICATIONS MANAGEMENT**

#### **CHAPTER 12 PLANNING FOR EMERGENCY AND DISASTER COMMUNICATIONS**

|  |       |
|--|-------|
| GENERAL  | 12.1  |
| Planning   | 12.3  |
| Authority  | 12.4  |
| Roles and Responsibilities                         | 12.5  |
| Control and Coordination                           | 12.6  |
| Inter-Agency Communications                        | 12.7  |
| Resources  | 12.10 |
| Communications for Specific Operational Situations | 12.11 |
| Network Diagrams                                   | 12.12 |
| Redundancy   | 12.13 |
| Planning Detail                                    | 12.14 |

#### **CHAPTER 13 THE COMMUNICATIONS CENTRE**

|                                      |       |
|--------------------------------------|-------|
| GENERAL                              | 13.1  |
| Communications Centre Responsibility | 13.2  |
| COMCEN Organisation                  | 13.3  |
| Registration of COMCEN Messages      | 13.4  |
| Message Handling Principles          | 13.5  |
| Communications Centre Layout         | 13.6  |
| COMCEN Staff                         | 13.7  |
| COMCEN Supervisor                    | 13.8  |
| Staff Welfare                        | 13.9  |
| Silent Telephones                    | 13.10 |
| Noise and ACCESS                     | 13.11 |
| Emergency Operations Centre Siting   | 13.12 |
| Basic Message Forms                  | 13.13 |

|  |       |
|--|-------|
| <b>CHAPTER 14 ORGANISATION OF COMMUNICATIONS IN THE FIELD</b>                                  |       |
| GENERAL  | 14.1  |
| The Importance of a Communications Plan  | 14.2  |
| ORGANISATIONAL ELEMENTS  | 14.5  |
| Reconnaissance of the Field Operations Centre ('Time Spent in Reconnaissance is Never Wasted') | 14.5  |
| Site Survey  | 14.7  |
| Equipment Installation   | 14.8  |
| Operation  | 14.9  |
| Closing Down   | 14.10 |
| Post-Operation   | 14.11 |
| FIELD COMMUNICATION TECHNIQUES   | 14.12 |
| FIELD COMMUNICATIONS EQUIPMENT MANAGEMENT  | 14.23 |
| Battery Management   | 14.24 |
| <br>   |       |
| <b>CHAPTER 15 MISCELLANEOUS COMMUNICATIONS ISSUES</b>  |       |
| COMMUNICATION SURVEYS  | 15.1  |
| Survey Technique   | 15.2  |
| Performance Maps   | 15.3  |
| Equipment Performance Variations   | 15.4  |
| Setting Priorities   | 15.6  |
| Benefit  | 15.7  |
| PUBLIC INFORMATION   | 15.8  |
| Dissemination  | 15.9  |
| LICENSING OF RADIO TRANSCEIVERS  | 15.10 |
| Management   | 15.11 |



## OCCUPATIONAL HEALTH AND SAFETY ISSUES

Occupational Health and Safety arrangements may vary between organisations but must always be taken into consideration when using communications equipment.

Some hazards that may be encountered include:

- a. electrical storms;
- b. electric shock;
- c. electromagnetic radiation (EMR); and
- d. mechanical risk (eg antenna hardware).

Before operating any communications equipment, users should check with the manufacturers' handbooks and relevant occupational health and safety arrangements.

Archived

# INTRODUCTION

## THE COMPREHENSIVE APPROACH TO EMERGENCY/DISASTER COMMUNICATIONS MANAGEMENT

Disasters cause economic and community chaos. Lives are lost, injuries sustained, families disrupted and jobs are often lost. The inevitable interruption to industry and commerce usually has significant economic consequences at local, regional and national levels.

Communications are vital in responding to disasters and continuing efforts are necessary to ensure that equipment and service providers are responsive to the needs of the public safety agencies. On a number of occasions, failure of electronic communications has been a major problem in disaster response. Not only should equipment be serviceable and reliable, but effective management of communication resources and information is essential during emergencies and disasters.

Communication networks will be required between organisations and agencies to ensure proper coordination of preparedness measures and response operations.

There is also a requirement for community information, which covers prevention, preparedness, response and recovery (PPRR). People must be aware of hazards they face and how to avoid them, or reduce their effects. They need to be aware of emergency/disaster management arrangements in their local area and when a threat emerges they must be warned of it and advised what to do before and post-impact.

Typical communication measures under the elements of PPRR include the following:

### **Prevention/Mitigation:**

- e. Correct siting of communication assets, ie telephone exchanges, mobile phone facilities, broadcast stations and major computing networks.
- f. On-going access to the legislative planning process, eg Radio Communications Act, Telecommunications Act and any emergency management legislation.
- g. On-going access to communications regulator, the Australian Communications Authority (ACA), for the allocation of national channel blocks and special licensing conditions.
- h. Efforts to include communication carriers and service providers in the disaster management education process. This will assist them to 'harden' their systems so that they are less vulnerable in times of disaster.
- i. Access to the public information planning process.
- j. State level plans will need to deal with the assessment of the risk to public Planning arrangements for the restoration of these facilities is an important factor.

### **Preparedness:**

- a. Emergency/disaster communication plans should be strategic in nature and focus on the larger issues.
- b. All plans should be regularly exercised and reviewed.

- c. Training must support the communication plans.
- d. Detailed inventories should be kept on all key communication assets and their locations eg transportable mobile telephone cell, and satellite communications equipment, portable repeaters etc.
- e. The communications aspect of community awareness, information and warning systems should be implemented.

**Response:**

- a. Communication plans should be implemented as required.
- b. Communications coordination should occur across organisations at the highest level, at the same time allowing each organisation to operate in an autonomous fashion, with sufficient communication assets to perform their core business.c. Communications resources should be mobilised.

**Recovery:**

- a. Essential community communications should be restored, recognising that even if the normal communication facilities of a community are unaffected by the disaster, they will almost certainly be insufficient to support the recovery of that community.
- b. Communication resources should be provided to relief agencies.
- c. Communications should be provided for community awareness.
- d. Physical restoration of communications infrastructure should be undertaken, ie telephone network, broadcast, radio, television and computer networks.

**AUSTRALIAN EMERGENCY MANUAL  
COMMUNICATIONS**

**SECTION 1**

**COMMUNICATIONS SYSTEMS AND METHODS**

All emergency service personnel need to have some knowledge of communications methods and systems. Without this knowledge emergency/counter-disaster operations may be adversely affected.

Section 1 contains an introductory overview of the significant communications methods and lists their advantages and disadvantages, together with a basic description of operation.

Section 1 should be understood before referencing other sections of this Manual.

## SECTION 1—COMMUNICATIONS SYSTEMS AND METHODS

# CHAPTER 1

## TELECOMMUNICATIONS NETWORKS

### INTRODUCTION

#### 1.1 NATIONAL NETWORK

Australia's national telecommunications network comprises the Public Switched Telephone Network (PSTN), sophisticated data networks, cellular telephone systems and satellite communications. These networks comprise vast local and trunk systems of complex electronic switching systems connected by wire, optical fibre, digital and analogue radio and coaxial cable systems. Australia's national telecommunications system is regulated by the Australian Communications Authority (ACA) and serviced, supported and maintained by various network service providers.

#### 1.2 SPECIAL EMERGENCY AND DISASTER SERVICES

Carriers and service providers, eg Telstra, Optus, may arrange specialised services to disaster-affected areas at relatively short notice. These services extend beyond the normal range of telecommunication facilities and can be arranged through an emergency/disaster liaison officer. This officer should be identified in every disaster plan.

#### 1.3 TELECOMMUNICATION NETWORK FEATURES

The majority of Australian premises are serviced by the telephone network and most people are familiar with its operation. Network security is enhanced by diversity of switching centres and trunk carrier terminals, alternative routing and site-hardening against natural and other hazards. However, the network is designed to handle normal traffic loads and disruption to the network can still occur due to traffic congestion or physical interruption, especially in disaster-affected areas.

### TELEPHONE SYSTEMS

#### 1.4 TELEPHONE EQUIPMENT

There are many types of telephone equipment in use throughout Australia, from basic function handsets to the sophisticated multi-function display key stations. All telephones connected to the telephone network must have an ACA (previously Austel) permit number.

#### 1.5 FIXED WIRE TELEPHONE NETWORK

The majority of telephones in Australia are connected to fixed wire telephone systems; these have a number of advantages and disadvantages:

| <b>Advantages</b> | <b>Disadvantages</b>          |
|-------------------|-------------------------------|
| Already in place  | In a fixed location           |
| Versatile         | Calls can be disrupted        |
| Public access     | Priority to larger users      |
| Reliable          | Vulnerable to physical damage |

### Advantages

High traffic density  
Two way conversations  
User friendly  
Privacy

### Disadvantages

Can reach saturation and congestion  
Not always available  
Point-to-point only

## 1.6 CELLULAR (MOBILE) TELEPHONE SYSTEMS

The cellular telephone comprises calling areas divided into cells each of which is serviced by a low powered transmitter. The cells are interconnected and as a mobile user moves from one cell to another, responsibility for call control is passed to the cell being entered. Coverage is limited to major cities, towns and other populated areas where a reasonable demand for the service exists. The cellular system provides full access to the PSTN and is growing at a rapid rate, both in terms of telephones in use and the area coverage.

1.7 There are two mobile telephone systems in general use in Australia, analogue and digital, with three types of telephones available. They are:

- a. personal portable (handheld) – low power with a low gain antenna;
- b. transportable carry pack – medium power with a low gain antenna; and
- c. vehicle mounted – medium power with a high gain antenna.

**Note:** Cellular telephones are subject to congestion in the same way as the normal telephone network.

1.8 Advantages and disadvantages of mobile phones are as follows:

### Advantages

High mobility  
International roaming with GSM  
Adaptable to fax and data  
Personal communications  
Low equipment cost

### Disadvantages

Congestion can occur  
Limited by battery capacity  
Coverage is limited in some areas  
Wide variations in equipment  
No broadcast capability

**Note:** Cellular telephones should not be relied upon as the primary operational method of communications unless all other avenues have been exhausted.

## 1.9 FIELD TELEPHONE SYSTEMS

Military-type field telephones or domestic intercom systems can be effective alternatives for point-to-point communications in disaster operations. They can relieve congestion for short distance transmissions, are easy to install and are not connected to the PSTN. However, field telephone equipment can be difficult to obtain and the cable interconnecting the units is easily damaged. Domestic intercom systems are readily available from retailers.

## **FACSIMILE**

### **1.10 DESCRIPTION**

Facsimile (FAX) machines provide a capability to transmit and receive written messages, printed text, maps or drawings over telephone lines. Capabilities vary from machines which are simple to operate to advanced machines providing one-touch and coded speed dialing lists and timed transmissions.

### **1.11 SYSTEM**

Most facsimile machines operate over the PSTN; others may operate on digital mobile telephones, radios and satellite systems. Fax communications can be subject to disruption especially in disaster affected areas. Under normal circumstances faxes are sent one at a time, or sequentially if there are multiple addressees. However, Faxstream provides for multiple simultaneous transmission from the one source document. In addition, facsimiles can be sent to and from computers which have internal fax boards fitted or fax/modems connected to a communications port.

### **1.12 COPY LIFE**

Faxes printed on thermal paper rolls are subject to deterioration. If long term retention is required, the reproduced fax should be photo copied. Most modern fax machines print on plain A4, which has the advantage of a single source of paper supply for both photocopier and facsimile. Proof of the transmission may be provided to both the originator and the receiver.

### **1.13 ADVANTAGES AND DISADVANTAGES**

| <b>Advantages</b>   | <b>Disadvantages</b>   |
|---|--|
| Low cost method of sending and receiving manuscripts, maps and text traffic | Thermal paper (if used) has a short life and will fade             |
| Easy to operate   | Time taken to transfer multiple pages                              |
| Multiple address transmission possible                                      | Congestion - may require two or more machines and lines            |
| Plain paper available   | Information management requirement                                 |
| Widely used at home and office  | Cannot receive while sending                                       |
| Can be used over line, satellite, computers, or radio                       | Unless automatic, manual resending is required if destination busy |
| Receipt available to confirm success or otherwise of transmission           |  |
| Highly reliable   |  |
| Message received without operator intervention                              |  |
| Operates on any telephone line  |  |

## **PAGERS**

**1.14** Pagers are inexpensive, portable and personal communication devices. They provide one way communication from a central dispatch point to the pager concerned and can be used to contact individuals or groups. Users should be aware that delays might occur in the message being delivered. The message

transmitted may consist of voice, numbers and letters (alphanumeric) or a tone, which requires a predetermined response. Tone, voice or alphanumeric pagers do not necessarily verify the receipt of the message.



Figure 1:1—Alpha Numeric Personal Pager

### 1.15 ADVANTAGES AND DISADVANTAGES

| <b>Advantages</b>  | <b>Disadvantages</b>                |
|--|-------------------------------------|
| Low cost of one way communications                             | One way messaging                   |
| Often the range exceeds that of cellular phones                | Response not guaranteed             |
| Multiple users can receive the same information - Group Paging | Hardware variations                 |
| Message can be stored in the pager until required              | Supplier diversity                  |
| Low power requirements   | Limited coverage/range              |
| Widely used  | No confirmation of message received |
| High reliability   | Battery life                        |

## SATELLITE COMMUNICATIONS

### 1.16 LONG RANGE COMMUNICATIONS

Communication satellites offer the capability to communicate over long distances with high quality. Unlike High Frequency (HF) radio, these circuits are not subject to fading or disruption from ionospheric effects. However, some frequencies used for satellite communication are subject to disruption during heavy rain.



## 1.17 CONCEPT

The basic concept of satellite communication systems is that an earth station transmits a signal to the satellite, which retransmits the signal to other ground stations.

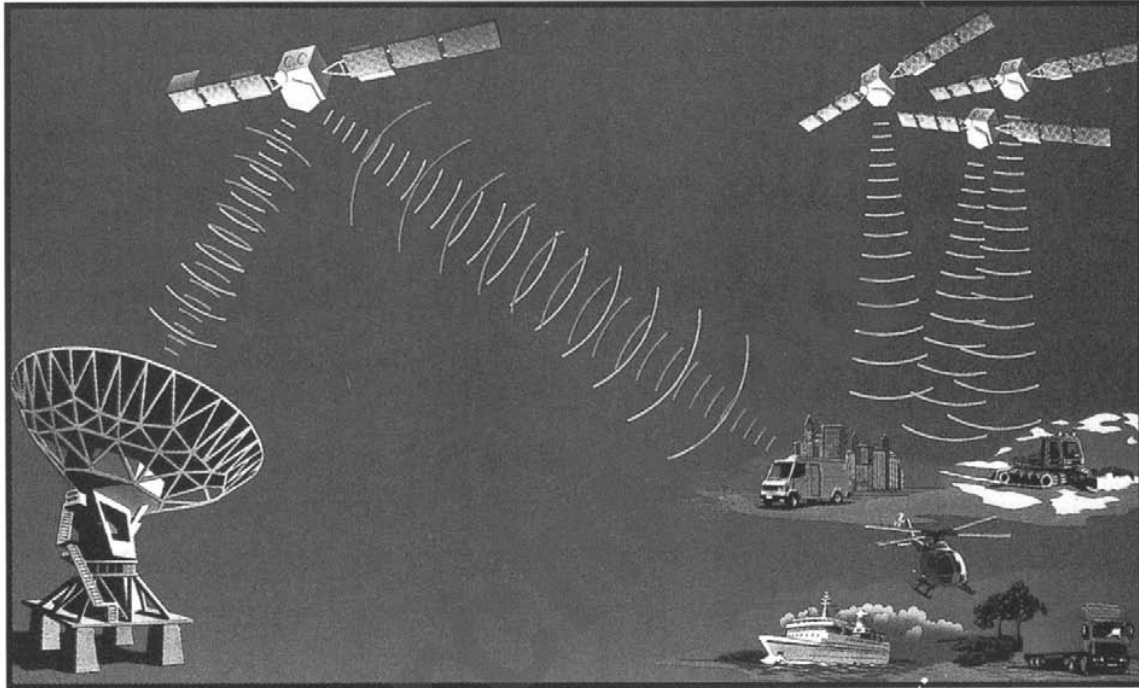

Figure 1:2—Satellite/Earth Station

## 1.18 TELEPHONE CONNECTION

Most satellite systems provide connections to the telephone system via earth stations in Australia or internationally which permit users to make telephone calls, transmit data or send facsimile messages. Satellite communication systems are affected by network congestion unless special management arrangements have been made with service providers.

## 1.19 SIZE

Advances in technology have resulted in a reduction in size and complexity of field earth stations, from large trailer mounted assemblies to suit case size and now to notebook size. With the introduction of low earth orbiting satellites, hand-held units are becoming available.



Figure 1:3—Portable Earth Station

## 1.20 ADVANTAGES AND DISADVANTAGES

### Advantages

- Small size of mobile & portable earth terminals
- Equipment cost reducing
- Diversity of satellites & land earth stations
- Satphone to Satphone communications available
- Competitive field for equipment & call charges
- Secure communications between earth stations
- Help desk facilities available
- Capable of carrying voice, fax & data via the PSTN
- Message storage system capability
- Mobile or fixed installations
- Range of power supply options
- Not affected greatly by weather

### Disadvantages

- Clear line of sight to satellite required
- Limited (if any) broadcast capability
- Slow transmission speed of fax and data
- Relatively high call charges when compared to cellular phone charges
- EM Radiation hazard to personnel in front of the antenna while equipment is transmitting
- User friendly

## PERSONAL COMPUTERS AND DATA TRANSMISSION

1.21 The use of computers for day-to-day tasks is generally well accepted. The combination of computing power and high speed data communications provides the connectivity to share information and resources in local and wide area networks.

### 1.22 NETWORKS

A local area network (LAN) provides a system for intercommunication between personal computers, workstations, printers and related equipment operating within the same general area. The network is controlled by a file or application server which controls user access to corporate information, data, printers and

gateways. For example, staff records, incident details, requests and offers, contact details and Standard Operating Procedures (SOPs) can be stored in electronic form and accessed quickly by authorised users. Wide area networks (WAN) interconnect remote sites to main systems and local area networks to one another via gateways.



Figure 1:4—Personal Computer (PC)

### 1.23 PC ADVANTAGES AND DISADVANTAGES

| <b>Advantages</b>                                       | <b>Disadvantages</b>  |
|---|---|
| Ability to store information electronically             | Hardware limitations  |
| Remote access via PTSN possible                         | User reluctance to change   |
| Relatively high speed transmission of information       | Incompatibility of some systems                                       |
| Possible increased user productivity                    | Extensive hardware/variations   |
| When linked, users have access to shared information    | For high speed data transmission, costly wide band paths are required |
| One machine can perform many tasks                      | Rate of change & maintenance of knowledge                             |
| Access to a world wide communications system (Internet) | Systems rapidly become obsolete                                       |

## **1.24 COMPUTER-AIDED DISPATCH**

By using radio networks, Computer-Aided Dispatch (CAD) systems can transmit data to Mobile Data Terminals (MDT) in vehicles. This allows information such as job allocation, current status, map information or details on chemical hazards to be interchanged promptly and accurately at a fast rate.

**1.25** In addition, MDTs and hand-held units allow the user in the field to access central databases for information on license details, patient records, car registrations and the like. Police, fire, ambulance, taxi and courier companies use these systems to increase the efficient use of the radio spectrum.

## **1.26 DATA COMMUNICATIONS**

The development of data communications evolved from the nature of computer systems. Local and wide area networks enable users on multiple sites to gain access to several computers in the same network by using modems, bridges and routers.

**1.27** A wide variety of transmission media is available to the network designer and many networks employ several of them. Twisted pair cable, coaxial cable, fibre optics, microwave and satellite channels have information-carrying capacity which varies from a few characters per second to millions of characters per second. The terms bit rate, baud rate and bandwidth are used to describe a medium's carrying capacity and these measures are interrelated.

**1.28** Although computer data is represented in digital form, large amounts are transmitted in analogue form as transmission facilities were designed for analogue voice transmission. However, digital networks like Integrated Services Digital Network (ISDN), voice, data and images are transmitted digitally. Digital networks have lower error rates, higher transmission rates, better security and do not require digital to analogue conversion and back to digital.

## **1.29 ELECTRONIC MAIL**

Electronic mail, referred to as E-mail, is the ability to transfer messages electronically. A data communications system serves as the delivery medium with E-mail software providing the network mail delivery function. There are public and private mail systems; a private system is controlled by a company and is available only to users within that company. A public mail system is provided by an electronic mail provider, for a fee, usually an Internet Service Provider (ISP), where mail can be routed to unique personal addresses anywhere in the world which have access to the Internet and a service provider. Thus, a manager travelling from one office to another can access mail regardless of their location.

**1.30** Distribution of mail is rapid; messages are usually available to recipients within minutes. Multiple addresses have access to the same message at the same time. Documents, images and computer programs can be attached and sent with the message. However, download of attachments requires a high speed modem and a fast local telephone line as large files take a considerable time to download; one hour is typical for a 4Mb file.

## **1.31 INTERNET**

The Internet is made up of millions of computers linked in many ways so they can exchange messages, files, video, sound and programs. It is often described as a network of networks, but this is only one aspect of the Internet.

When a user is actually logged on to the 'net', boundaries disappear. A single command can take the user across several countries and the user may not know where in the world the computer they are connected to is located.

**1.32** The technical complexity of the Internet is hidden. The system is made up of millions of links which provide access to other addresses on the 'net'. These links are provided by telephone lines, ISDN phone lines, trunk lines, microwave links and satellite links. A user has to make a connection to the Internet via a modem, phone line, personal computer, software to drive the modem and software with which to 'browse' the net.

### **1.33 WORLD WIDE WEB**

The World Wide Web (or the Web or WWW) is the most organised and easiest part of the Internet to use. The software application, called a browser, used to access the Web has a Windows type interface and is easy to use. The Web server, on which the home page is resident, provides the raw data: text, images, video and audio. The user's software takes the data and uses the formatting commands embedded in the text files to present it on the user's screen. Browsers available are Netscape Communicator/Navigator and Microsoft Internet Explorer.

Archived

**Archived**

## SECTION 1—COMMUNICATIONS SYSTEMS AND METHODS

### CHAPTER 2

#### OTHER COMMUNICATIONS METHODS

##### 2.1 COURIER SYSTEMS

2.2 Courier systems are used for the hand delivery of information by persons using aircraft, vehicles or boats. They are flexible and bulky items can be moved, but they are costly, time consuming and personnel intensive.

##### 2.3 VISUAL/AUDIBLE SIGNALS

2.4 Visual and/or audible systems are basic methods of passing information to others, or to attract attention. They may include hand signals, lights, sirens, whistles or voice. Such systems are inexpensive and require little infrastructure. However, they have limited coverage and are affected by weather.

##### 2.5 PUBLIC MEDIA

2.6 The public media is used extensively for dissemination of information to the public in times of disaster through radio, television and newspapers. The media is easily accessible and reaches a large audience by voice and visual means. However, the audience can not be selected and reception can not be guaranteed. Content is difficult to control and is one-way.

Archived

**Archived**



## CHAPTER 3

# RADIO COMMUNICATION NETWORKS AND SYSTEMS

### RADIO NETWORKS

#### 3.1 FEATURES

Extensive radio communication networks and systems operated by government and private agencies are in use throughout Australia. The networks comprise long-range medium or short-range networks using fixed, mobile and portable equipment.

**3.2** Technological advances have resulted in the integration of radios and computers to ease the problems of network congestion and inefficient spectrum use. These advances include the development of trunked radio which can have both operational and cost advantages.

#### 3.3 FREQUENCY BANDS

Emergency service agencies operate equipment on different frequency bands including:

- a. High Frequency (HF);
- b. Very High Frequency (VHF);
- c. Ultra High Frequency (UHF); and
- d. Super High Frequency (SHF).

**3.4** Radio communication equipment is usually referred to as two-way radio or radio transceiver. To allow a communication between any two radio transceivers, both radios **MUST** operate on the same channel in the same frequency band.

#### 3.5 ADVANTAGES AND DISADVANTAGES

| <b>Advantages</b>                                     | <b>Disadvantages</b>                        |
|---|---|
| Flexible  | One transmission at a time                  |
| Communication to vehicles, people, aircraft and boats | Requires trained operators                  |
| No physical connection                                | Low traffic capacity                        |
| Networking is possible                                | Subject to interference                     |
| Broadcast is possible                                 | No security without special measures        |
|   | May be limited by terrain and or atmosphere |

### RADIO TRANSCEIVERS—GENERAL

**3.6** There are a number of different types of radio transceivers. Some of the more common types of equipment used by emergency services are described in the following paragraphs.

### **3.7 BASE STATION**

A base station is an essential part of any radio communication system and is usually installed in a fixed location. The function of the base station function is central control for the dispatch and receipt of messages or information to field personnel.

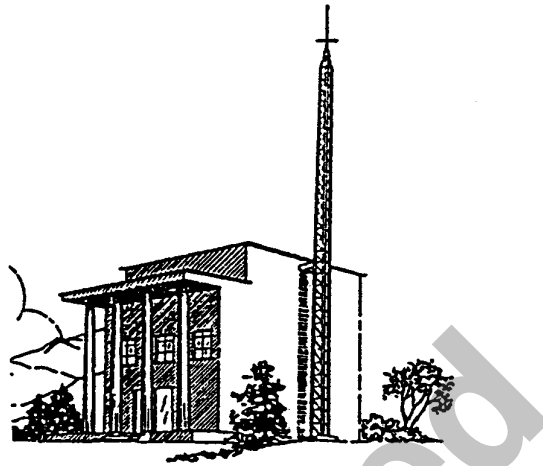

Figure 3:1—Local Control Base Station

### **3.8 REPEATER BASE STATION**

An alternative type of base station is known as a talk-through repeater base station. They can be fixed or portable and function by receiving a signal and retransmitting it automatically.

- 3.9** By locating this type of station on an elevated site, mobile to mobile communications can often be extended to distances in excess of 100 km. Further information is contained in Section 2 of this manual.

## **MOBILE RADIO TRANSCEIVERS**

### **3.10 TRANSCEIVERS**

Mobile radio transceivers are designed to be fitted to vehicles with power permanently connected to the vehicle battery. Where some vehicles present mounting difficulties, a remote control unit is placed within easy reach of the operator, allowing the transceiver to be installed in a more convenient location (eg boot mounting).

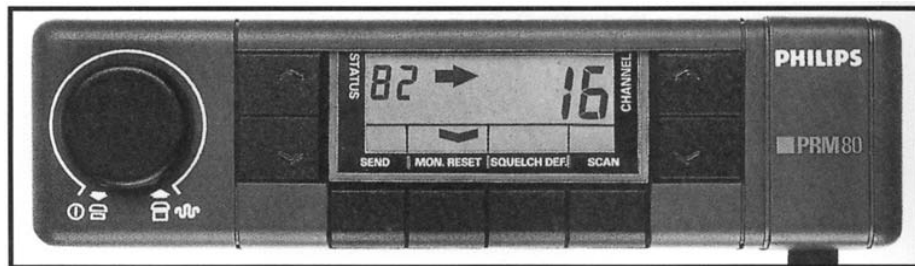

Figure 3:2—Mobile Radio Remote Control Unit

### 3.11 ANTENNAS

A variety of antenna configurations and installations can be used and are determined by considering:

- a. performance requirements;
- b. mechanical convenience; and
- c. aesthetic appeal.

3.12 HF multi-frequency transceivers are used with antennas that require adjustment according to the frequency in use. Some of these antennas are automatically tuned. Other types require manual selection according to the frequency.

### 3.13 INTERFERENCE

Care is required to ensure that vehicle electronic/electrical systems and radio transceivers do not interfere with each other. Ancillary equipment must not be connected to the permanent power lead of a mobile radio transceiver, as it may cause current overload of the power lead and interference to the transceiver.

## HAND-HELD PORTABLE RADIO TRANSCEIVER

### 3.14 PORTABILITY

Hand-held portable transceivers are designed to be conveniently carried by a person and may be attached to waist belts or shoulder straps for ease of carrying.

### 3.15 SIZE

Portable transceivers are physically small and have output powers up to 5 watts. Small battery packs are fitted to them which results in lower range and endurance than that achieved with mobile transceivers. Battery packs normally employ 'Nicad' cells, which are rechargeable; dry cell packs may also be available.



Figure 3:3—VHF/UHF Hand-Held Portable Transceiver

### **3.16 PERFORMANCE ENHANCEMENT**

The performance of hand-held transceivers is enhanced when they are used with repeater base stations.

## **MANPACK PORTABLE RADIO TRANSCEIVERS**

### **3.17 FEATURES**

Manpack portable transceivers consist of a backpack containing a mobile transceiver attached to a battery case. The entire set is larger and heavier than a hand-held portable and offers improved range and endurance. A manpack portable radio transceiver usually comprises:

- a. HF/VHF/UHF Mobile radio transceiver;
- b. battery and charging circuitry;
- c. external loud speaker;
- d. microphone, connector and bracket;
- e. antenna and or antenna connection;
- f. battery charger (240 volt AC);
- g. battery charger lead (12 volt DC); and
- h. canvas carry bag.

### 3.18 USES

Repackaging of some of the above items enclosed within or attached to a metal case offers versatility and can be used as a:

- a. base station with external elevated antenna connected and powered by the internal batteries on permanent charge;
- b. portable mobile with external vehicle antenna powered from its own internal batteries or the vehicle battery; or
- c. portable radio operating with its own antenna and internal batteries.

### 3.19 BATTERY RECHARGE

A manpack portable radio can usually be operated for about 8 hours before without recharging of the batteries.



Figure 3:4—Manpack Portable Radio Transceiver

**Archived**

## CHAPTER 4

# COMMUNICATION EQUIPMENT OPERATION AND PROCEDURES

### TELEPHONE PROCEDURES

#### 4.1 ANSWERING

Answer the telephone promptly. When answering a call, identify yourself and your station or position. Do not say 'HELLO', as it is meaningless and wastes time.

#### 4.2 CALLING

When making a call, identify yourself, your station and state the purpose of your call. Clear speech and precise diction are essential.

#### 4.3 BACKGROUND NOISE

When using a telephone in a noisy environment, a hand cupped over the mouthpiece will reduce extraneous noise being transmitted and may also assist the user to hear conversations with less noise.

### RADIO COMMUNICATION PROCEDURES

#### 4.4 BASIC RADIO OPERATING PROCEDURES

Basic radio operating procedures are used for the following reasons:

- a. The Radio Communications Act requires a radio service to be controlled by competent operators.
- b. Radio communications may suffer from interference, which can result in misunderstood messages.
- c. Communication is only possible in one direction at a time. If two or more persons transmit at the same time on the same frequency, neither message will be received.
- d. In emergency or poor operating conditions, radio traffic becomes congested and accuracy can suffer.

#### 4.5 BENEFITS OF STANDARD PROCEDURES

The use of standard procedures ensures:

- a. brevity;
- b. accuracy;
- c. speed; and
- d. simplicity.

## 4.6 USER FACTORS

The following 'user factors' (which form the acronym RSVP) will assist in achieving successful transmission of messages:

- a. **Rhythm**—Ordinary conversation has a natural rhythm, which needs to be preserved when speaking on radio. Say messages in short complete phrases that make sense not word by word. Avoid using redundancies like 'you know' or 'er'.
- b. **Speed**—Speak slightly slower than in normal conversation, avoiding rushing or slurring words. Pause between phrases to give the receiver time to write down the message if necessary.
- c. **Volume**—peak slightly louder than normal conversation. Avoid shouting.
- d. **Pitch**—Use a normal or slightly higher pitched voice.

## 4.7 PROWORDS

Prowords are pronounceable words or phrases, which have an assigned meaning for the purpose of expediting message transmissions. Examples of common prowords and their meanings are as follows:

- a. **'Roger'**—Message received and understood.
- b. **'This is'**—Used in conjunction with an identifying radio call sign.
- c. **'Over'**—My transmission is ended and I expect a reply (Never used in conjunction with OUT).
- d. **'Out'**—My transmission is ended, I do not expect a reply (Never used in conjunction with OVER).
- e. **'Say again'**—Repeat all of your transmission again (Or identified portion of the message).
- f. **'Wait'**—I must pause during my transmission.

## 4.8 RADIO CALL SIGNS

Call signs are used to identify stations on a network. The Australian Communications Authority (ACA) issues a network call sign (or call signs). However, in some cases, individual organisations may allocate place names and numbers, used alone or in conjunction with the ACA call signs. Some examples are as follows:

- a. ACA call sign VKX777
- b. Individual call sign Curtin Mobile 2
- c. Abbreviated call sign Curtin 2

The use of call signs on every transmission is unnecessary and wastes time. However, where there is a risk of confusion, full call signs should be used.

## RADIO EQUIPMENT OPERATION

### 4.9 CONTROL FUNCTIONS

The majority of radio transceivers manufactured for the Australian market have a number of switches, controls or indicator lights that perform the following functions:



- a. **Power on-off control**—This switches the radio on or off.
- b. **Volume control**—This controls the level of sound from the speaker and should be set for a comfortable listening level.
- c. **Mute/squelch control**—This eliminates background noise; its setting is critical for the correct operation of the receiver. Refer to individual equipment instructions.
- d. **Channel/frequency control**—This selects the channel/frequency. The correct channel/frequency **MUST** be selected or communications contact **WILL** fail.
- e. **Indicator lights**—These indicate various functions such as power on, signal receive, transmitter on, and channel number. Variations may occur between manufacturers.
- f. **Microphone**—This comprises two major components:
  - (1) A 'Push to Talk' switch (PTT) which is used to transmit a message.
  - (2) A microphone to convert voice to electrical impulses.



Figure 4:1—Mobile Two Way Radio Transceiver

#### 4.10 RECEIVING MESSAGES

To receive a message:

- a. Turn the ON/OFF switch to the ON position. (This switch may include other functions, ie volume or Mute/Squelch).
- b. Set the volume control to the mid position.
- c. Set the mute control, if fitted, until a rushing noise is heard.
- d. Reset the volume to a comfortable listening level.
- e. Reset the mute control, if fitted, until the rushing noise is just silenced. Do not advance this control further as weak signals will not be heard.
- f. Select the correct channel using the channel switch control:

- On receiving a call, reply with your radio call sign (eg 'Curtin 2 this is Curtin Base').
- After the message is complete, respond to the call, (eg 'Roger, OUT').

#### 4.11 SENDING MESSAGES

To **send** a message:

- Complete the steps listed in the sub-paras above, 'Receiving Messages'.
- Remove the microphone from holder.
- Listen before transmitting.
- When the channel is clear, raise the microphone to a position where the thumb touches the face.
- Depress the Push to Talk (PTT) button on the microphone:
  - Give the callsign of the station being called (eg **Curtin Base**);
  - Identify yourself (eg this is **Curtin 2**);
  - Speak briefly and transmit the message (eg **I am returning now, OVER**).
- release the PTT button and, if no further transmissions are required, return the microphone to its holder.

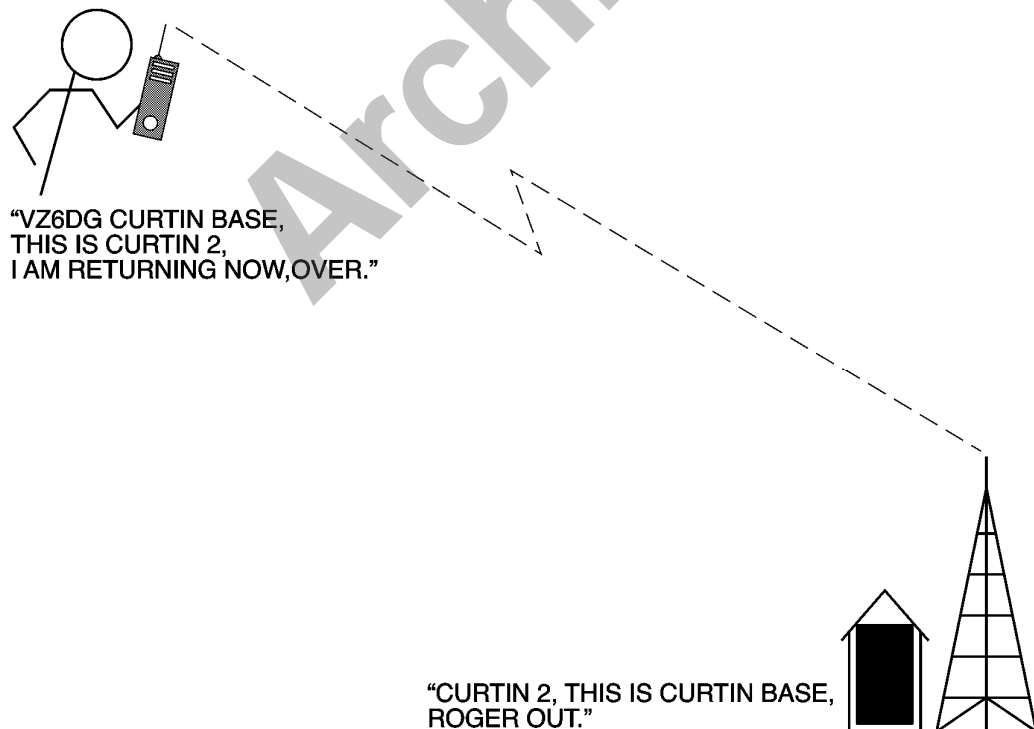

Figure 4:2—Making a Call

#### 4.12 TRANSMIT TIMERS

Many transmitters are fitted with a transmit timer to prevent transmissions for more than a preset period, usually one minute. Timers ensure that transmitters are not locked on continuous transmit by a jammed microphone button. Further information may be obtained from the network manager. Good operating procedures will ensure that transmissions are brief and do not exceed the preset time-out period.

#### 4.13 TRANSMISSION PRINCIPLES

Radio communications are multi-user facilities and require adherence to a number of basic principles when transmitting as follows:

- a. Listen before transmitting.
- b. Keep messages short and concise.
- c. Urgent or priority messages must be transmitted expediently, without dramatisation.
- d. Unusual person or place names may be spelt by using the phonetic alphabet.
- e. Long messages should be broken into natural sentences.
- f. If messages are required to be written by the receiving operator, the message should be transmitted at writing speed.
- g. Avoid the use of jargon terms.
- h. Do not use profane language on radio networks, they are not permitted by law.

#### 4.14 PHONETIC ALPHABET

The phonetic alphabet can be used to transmit difficult-to-pronounce words or place names.

|   |         |   |          |
|---|---------|---|----------|
| A | Alpha   | N | November |
| B | Bravo   | O | Oscar    |
| C | Charlie | P | Papa     |
| D | Delta   | Q | Quebec   |
| E | Echo    | R | Romeo    |
| F | Foxtrot | S | Sierra   |
| G | Golf    | T | Tango    |
| H | Hotel   | U | Uniform  |
| I | India   | V | Victor   |
| J | Juliet  | W | Whisky   |
| K | Kilo    | X | Xray     |
| L | Lima    | Y | Yankee   |
| M | Mike    | Z | Zulu     |

- 4.15 The excessive use of the phonetic alphabet wastes time on radio networks. Clarification of words can very often be made using plain English spelling without the need to resort to phonetic spelling.

#### 4.16 DIFFICULT CONDITIONS/WORDS

In poor conditions, difficult words or groups within the text of plain language messages may be spelt using the phonetic alphabet and preceded by the proword 'I SPELL'. If the operator can pronounce the word to be spelt, they will do so before and after the spelling to identify the word.

Catenary.....I SPELL....Charlie Alpha Tango Echo November Alpha Romeo Yankee.....catenary.

#### 4.17 PRONUNCIATION OF FIGURES

When figures are transmitted by radio, they should be pronounced as follows:

| <b>Figure</b> | <b>Spoken As</b> |
|---------------|------------------|
| 0             | Zero             |
| 1             | Wun              |
| 2             | Too              |
| 3             | thuh ree         |
| 4             | for wer          |
| 5             | fi yiv           |
| 6             | Six              |
| 7             | se ven           |
| 8             | Ate              |
| 9             | Niner            |
| 10            | wun zero         |
| decimal point | day see mal      |

Figures or numbers should be transmitted digit by digit, except that exact multiples of hundreds and thousands may be spoken as such. To distinguish numerals from words the proword 'FIGURES' is to be used preceding those numerals.

Examples of spoken numbers:

| <b>Number</b> | <b>Spoken As</b>                     |
|---------------|--------------------------------------|
| 44            | for wer for wer                      |
| 500           | fi yiv hundred                       |
| 7000          | se ven thow zand                     |
| 123.4         | wun too thuh ree day see mal for wer |

#### 4.18 PUNCTUATION

Punctuation is to be spoken as shown:

| <b>Punctuation</b> | <b>Spoken As</b>              |
|--------------------|-------------------------------|
| ,                  | comma                         |
| .                  | full stop                     |
| -                  | hyphen                        |
| ()                 | open brackets, close brackets |
| /                  | slant or slash                |
| “                  | quote, unquote                |

#### **4.19 MIXED GROUPS**

In transmitting a mixed group of letters and figures the prowords 'Figures' and 'I spell' are used as follows:

31—AB7 'Figures thuh ree wun hyphen, I spell, alpha bravo figure seven'

#### **4.20 GRID REFERENCES**

Grid references are sent digit by digit, preceded by the proword GRID. The prowords 'I SPELL' and 'FIGURES' are not required. A grid reference is easier to interpret if a pause is made between the eastings and northings.

Example GRID 97182 is sent as 'GRID 971 82'

#### **4.21 RADIO CHECKS AND SIGNAL REPORTS**

RADIO CHECKS ARE ESSENTIAL BEFORE DEPARTING A DEPOT OR BASE AND WHEN FIRST USING A RADIO AFTER DEPLOYMENT IN THE FIELD. THESE CHECKS ARE PARTICULARLY IMPORTANT BECAUSE THEY ENABLE FAULTY EQUIPMENT TO BE DETECTED AND REPLACED BEFORE OPERATIONS ARE COMMENCED.

**4.22** When testing a radio or establishing a link or network it may be necessary to exchange signal strength reports with the other station/s. Signal strength reports are as follows:

- a. Loud and clear (100% readability).
- b. Readable (good readability 90–100%).
- c. Weak readable (fair readability 50–90%).
- d. Unreadable (readability of less than 10%).
- e. Nothing heard (no signal heard, check for faults).

#### **4.23 SENSITIVE MESSAGE TRAFFIC**

On occasions emergency services may find it necessary to transmit sensitive information such as casualty lists and incident details. Because radio systems can be monitored, care should be taken to ensure that sensitive information is transmitted in a coded form. While electronic coding systems can be fitted to radio transceivers, a system of prearranged code words should be prearranged. Consideration should be given to passing sensitive information by other means, eg telephone (if mobile, GSM only) or personal contact.

#### **4.24 EXERCISE TRAFFIC**

During an exercise, transmissions should be periodically prefixed with 'This an exercise. In the event of a real emergency situation developing, the transmission should be prefixed with 'This is not an exercise'.

### **RADIO NETWORKS**

#### **4.25 RADIO LINK**

A radio link is two stations communicating with each other on the same operating frequency.

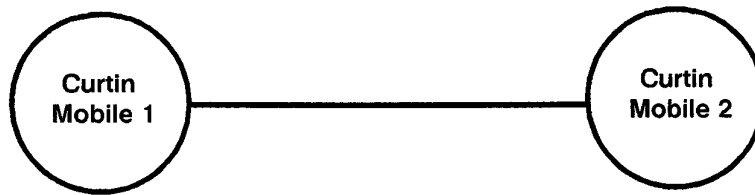

Figure 4:3—Radio Link

#### 4.26 RADIO NETWORK

A radio network is a group of radio stations communicating with each other on the same frequency.

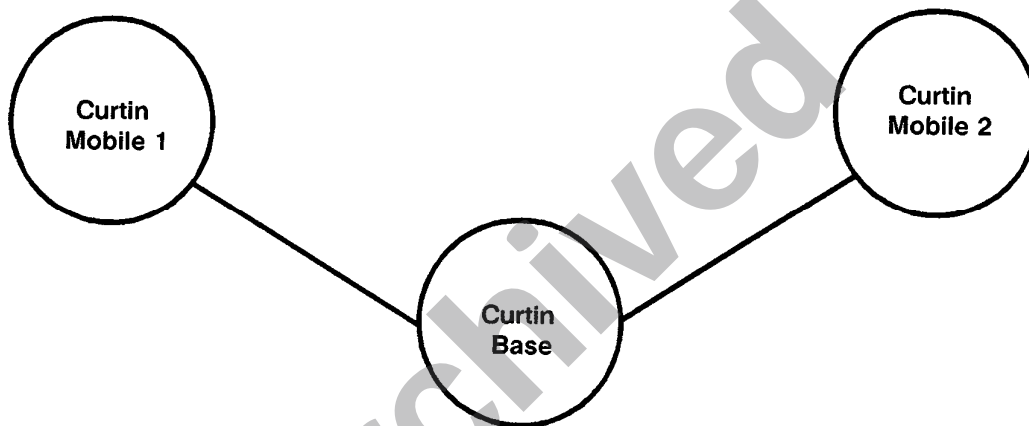

Figure 4:4—Radio Network

#### 4.27 CONTROL STATION

A Control Station is an assigned station responsible for network management which may include:

- a. direction of radio controlled vehicles or personnel;
- b. message handling; and
- c. network discipline.

### RADIO OPERATING CONDITIONS

#### 4.28 FADING

Due to terrain or interference, radio signals may fade or become unreadable. Fading is most noticeable when communicating with vehicles or portable radios. However, steps can be taken to improve radio communications when signals are deteriorating; these are:

- a. request vehicles or persons to stop or relocate;
- b. conduct radio checks until satisfactory communications are re-established, (relocation of one metre is sometimes sufficient).

#### **4.29 INTERFERENCE TO RADIO SIGNALS**

Interference is any effect that impairs the reception of a radio signal and can be natural, manufactured or a combination of both. Natural interference is most noticeable on some high frequency (HF) radio networks although very high frequency (VHF) and ultra high frequency (UHF) radio systems may also be affected. Natural interference is usually weather related and difficult to predict. Some sources of natural interference are:

- a. electrical storms;
- b. dust storms;
- c. rain;
- d. temperature inversions; and
- e. ionospheric disturbances.

#### **4.30 MANUFACTURED INTERFERENCE**

Manufactured interference is usually caused by electrically operated machinery and appliances and may sound like buzzing, humming or high-pitched squealing. This type of interference may be continuous or intermittent depending on whether the electrical devices are permanently operated or switched. Examples of manufactured interference are:

- a. high-tension powerlines;
- b. electricity supply systems and facilities;
- c. industrial machinery;
- d. computers;
- e. fluorescent lighting;
- f. neon lighting;
- g. electrically operated transport systems;
- h. vehicle control systems; and
- i. mobile telephones and other radio communication systems.

**4.31** Operators of mobile or portable radio communications equipment experiencing manufactured interference should select alternative locations, free from interference. Avoid using radios while under trees, in buildings, within industrial areas or under powerlines.

### **SUMMARY**

**4.32** The function of good radio operators is to send and receive messages efficiently. While they should take pride in achieving a high level of competence, they should not use exotic procedures or jargon which could confuse other users on the network.

**Archived**



**AUSTRALIAN EMERGENCY MANUAL  
COMMUNICATIONS**

**SECTION 2**

**ESTABLISHMENT, MAINTENANCE AND OPERATION  
OF COMMUNICATION SYSTEMS AND EQUIPMENT**

Section 2 provides sufficient information for emergency services personnel to establish, maintain and operate communication systems and equipment.

A full understanding of the information contained in Section 1 is necessary before reading this section.

**SECTION 2—ESTABLISHMENT, MAINTENANCE AND OPERATION OF  
COMMUNICATION SYSTEMS AND EQUIPMENT**

**CHAPTER 5**

**PUBLIC SWITCHED TELEPHONE NETWORK**

**INTRODUCTION**

- 5.1** The Public Switched Telephone Network (PSTN) is designed for average day-to-day traffic loads and functions efficiently under these conditions. However, at peak times such as during a disaster, the network can become congested. Although most emergency service personnel are aware of the normal telecommunications facilities, a number of specialised services are available which may not be known. Descriptions of some of these services and their capabilities are detailed below.

**EMERGENCY SERVICES LIAISON PERSONNEL**

**5.2 TRAINED PERSONNEL**

Telecommunication Carriers and Service Providers may make specially trained personnel available at state and regional centres to liaise with emergency service organisations. Due to their extensive knowledge of systems and procedures, these officers should be included in all levels of disaster management.

**5.3 SPECIALISED FACILITIES**

Emergency service liaison personnel can provide specialised communications facilities that may be required in times of emergency. Some of these facilities may include portable telephone exchanges, satellite communication services and disaster plan (DISPLAN) telephone lines.

**TELEPHONE EXCHANGES**

**5.4 GENERAL**

A telephone exchange is an extensive line switching system that permits the interconnection of a subscribers telephones within Australia or overseas. Exchanges are usually located within communities and are connected to other exchanges by various trunk circuits including lines, microwave bearers, optical fibres or satellite earth stations.

**5.5 PRIVATE AUTOMATIC BRANCH EXCHANGE**

The private automatic branch exchange (PABX) switches multiple external and internal telephone connections to specific locations, usually from within the subscriber's building. Modern PABX equipment offers a range of additional features such as call hold, call diversion, in-dialing, speed dialing and group pick-up. These and other features are controlled by computer software which can be re-programmed by trained support staff.

**5.6 ALTERNATIVE FACILITIES**

An alternative to the PABX may be made available from modern exchanges. These are capable of providing PABX-like facilities to individual subscribers.

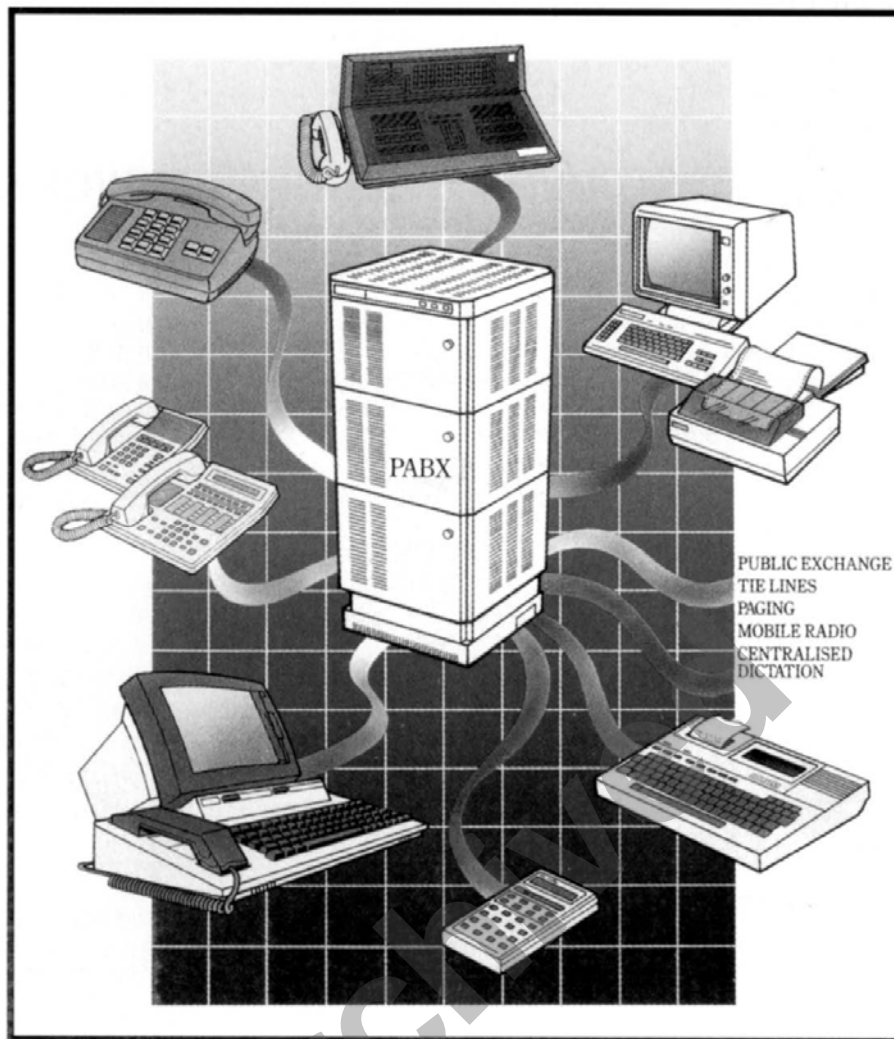

Figure 5:1—PABX

## TELEPHONES

### 5.7 GENERAL

Telephones use tone or pulse systems characterised by the dialing speed, with tone dialing being the faster of the two. A telephone that uses tone dialing is not usually directly interchangeable at the wall socket with a pulse telephone and vice versa. Care should be taken before interchanging telephones to ensure they are set to the correct dialing system. However, in some installations, specific wall-socket configurations inhibit connection of incorrect telephone appliances. All telephones must have an ACA (Austel) permit before connection to the PSTN.

### 5.8 SPECIAL TELEPHONE FEATURES

Modern telephone systems can now provide features previously only provided by a PABX, eg call waiting or call diversion.

## **5.9 GROUP ALERT CALLING**

Systems are available (such as Telstra's ERS7) that allow individual subscriber's telephones to be linked to a common call group so that calls for assistance from the public will cause all telephones to ring simultaneously as well as activating external audible alarms if required.

## **5.10 FAXSTREAM**

Faxstream is a digital network provided by Telstra to enhance the operational capability of standard facsimile (fax) machines. The digital system improves the speed of transmission, enhances the clarity of the printed copy and allows a simultaneous broadcast facility to other facsimile users. The normal fax machine is only able to communicate with one other fax machine at any one time.

**5.11** Faxstream works by having the subscriber's fax communicate with a Faxstream computer. The computer has access to multiple lines and thus can send a message to many locations simultaneously, ie broadcast.

**5.12** When all the faxstream messages are delivered, the originator is provided with a delivery receipt from the system computer. Because these receipts are treated as low priority, delays may be experienced in their return. Therefore, if urgency is a concern direct dial fax should be used. Machines on the Faxstream network can communicate with non-faxstream machines. Communication Managers may consider including their own fax machine number (or ideally, a receive-only fax machine) at the end of the faxstream group and thereby receive an indication that the messages have been delivered. (Faxstream is a propriety name and other carriers or service providers may provide a similar service).

## **5.13 CELLULAR TELEPHONES**

There are two cellular telephone systems available in Australia. The original system, known as Advanced Mobile Phone System (AMPS), is an analogue network and is due for phased withdrawal, in selected areas, in Year 2000. Global System Mobile (GSM) is a digital system which uses the spectrum more efficiently and offers particular advantages over the AMPS system, including better privacy and priority access.

**5.14** Some difficulty may occur with data or fax transmissions with the AMPS system, while the GSM will generally provide a more reliable transmission path. Telephones on either system communicate with the other through the PSTN.

**5.15** The risk of congestion is increased when cellular telephones are used, especially in major emergency or disaster situations and therefore they should only be used in a support role.

**Archived**

**SECTION 2—ESTABLISHMENT, MAINTENANCE AND OPERATION OF  
COMMUNICATION SYSTEMS AND EQUIPMENT**

**CHAPTER 6**

**OTHER SYSTEMS AND SERVICES**

**MARITIME RADIO SERVICE**

- 6.1** Telstra operate the Maritime Radio Service, a system of HF and VHF coastal radio stations which continually monitor specific frequencies. The Service provides manual or automatic (direct dialing) connection to the PSTN. Some coastal stations can be accessed by land mobile or portable stations.

**ROYAL FLYING DOCTOR SERVICE**

- 6.2** Royal Flying Doctor Service (RFDS) radio networks are primarily designed to provide access to medical help in remote areas. Other services may include education, telegram, telephone, and general radio communications. The radio service operates in the HF spectrum and emergency response is available 24 hours a day.

**WIRELESS INSTITUTE CIVIL EMERGENCY NETWORK**

- 6.3** The Wireless Institute Civil Emergency Network (WICEN) is a division of the Wireless Institute of Australia, the governing body for amateur radio operators. WICEN was formed to provide specialised radio communications for the community in times of disaster. Due to the extensive range of frequencies, equipment, and expertise available to them they may be usefully included in emergency or disaster plans.

**CITIZENS BAND RADIO SERVICE**

- 6.4** Citizens Band Radio (CB) is an inexpensive form of radio communication available for personal use. There are two frequency bands available for this service, HF (27MHz) and UHF. An extensive UHF repeater system is available across Australia.

**6.5 OPERATOR DISCIPLINE**

All CB radio systems are subject to disruption by poor operator discipline and should not be relied upon entirely for emergency operations. Both frequency bands have 40 channels available, which include designated emergency calling channels.

**SATELLITE COMMUNICATIONS**

- 6.6** An increasing number of civilian communication satellites are in use around the world. They perform a range of tasks including:
- a. two way voice transmission;
  - b. two way data transmission; and
  - c. public broadcasting.

The two way functions are those that are of special interest to emergency services personnel.

## 6.7 SERVICES

Two way services currently available in Australia are Optus (Mobilesat) which has Australia-only coverage and Inmarsat (SATCOM) which has world-wide coverage. The following table lists satellite systems and services available to users in Australia:

| Service Name                            | Modes               | Earth Station Size                        | Remarks   |
|---|---------------------|---|---|
| Optus KU band                           | Voice fax and data  | Trailer mount                             | 'ITERRA' (Telstra)<br>Services are provided by this service |
| Mobile Sat (Optus)                      | Voice fax and data  | Mobile (vehicle mount) or brief case size | Mobile can be used 'on the move'                            |
| SATCOM A/B* (Telestra)                  | Voice, fax and data | Suitcase size                             | Uses Inmarsat system  |
| SATCOM C* (Telestra)                    | Data only           | Briefcase size                            | Inmarsat system—operates in store and forward mode          |
| SATCOM M* (Telstra)                     | Voice, fax and data | Briefcase size                            | Inmarsat system   |
| SATCOM Mini M* (Telestra)               | Voice, fax and data | Notebook size                             |   |
| * These services offer global coverage. |                     |   |   |

## 6.8 FOOTPRINT OR COVERAGE

The area on the earth's surface covered by the signal from the satellite is known as the 'footprint' or coverage. The Optus footprint covers Australia and near adjacent areas. The footprint of SATCOM covers most of the globe, to 75 degrees S/N latitude.

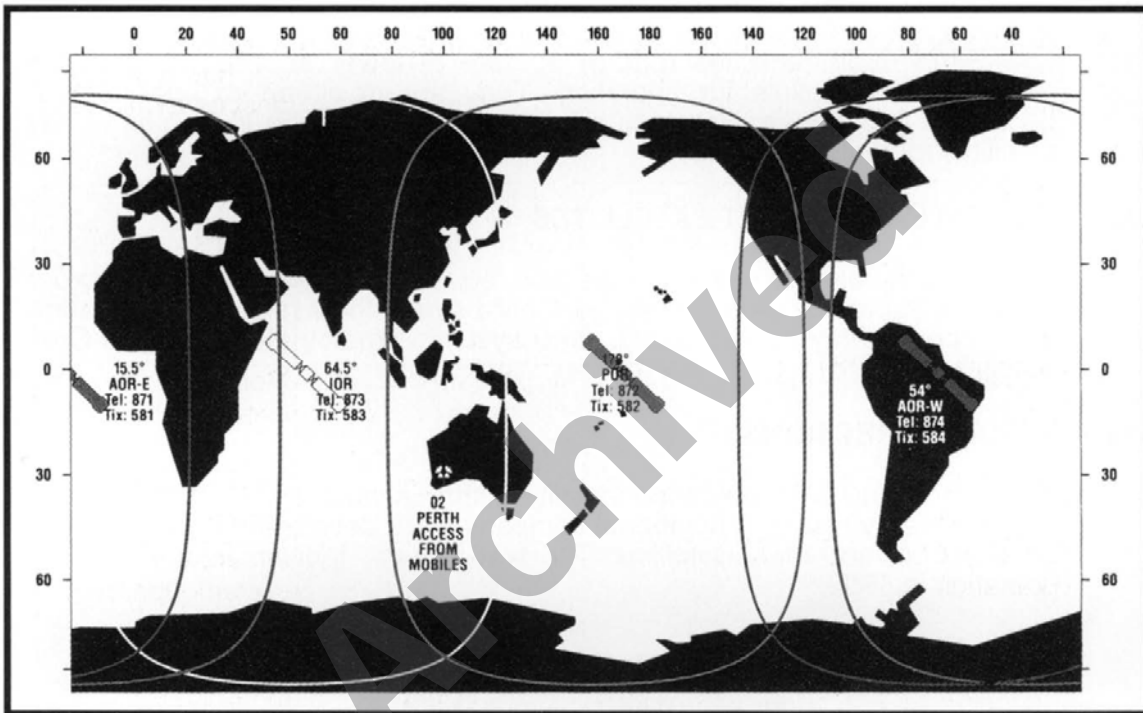

Figure 6:1—SATCOM Satellite Footprint/Coverage

## 6.9 ORBITS

When a satellite is placed in a critical orbit that maintains its position above a specific point on the earth's surface, it is said to be in a 'geo-synchronous' or 'geo-stationary' orbit. Geo-synchronous satellites orbit the earth at the same speed as the earth and are located approximately 36000 kilometres above the equator. These satellites cause a delay of 0.3 of a second in receiving speech.

- 6.10** Other satellites vary their position in relation to the ground and may only be visible at certain times. These satellites are able to deal with messages on a store and forward basis and are therefore more appropriate for data messages. Several orbiting satellites can be arranged in constellations so that messages can be transferred between satellites either direct or via earth stations. Store and forward operation is not necessary and therefore the constellations can handle voice, fax and data traffic in real time.



### **6.11 LOW EARTH ORBIT SATELLITES**

Low Earth Orbit Satellites (LEOS) operate at lower altitudes and require reduced power levels for operation. They are designed to operate with hand-held telephones. Networks employing LEOS require in excess of fifty satellites for global coverage.

### **6.12 MEDIUM EARTH ORBIT SATELLITES**

Increasing the altitude of the satellite orbit requires fewer satellites (in the order of twelve) to provide global coverage. Only a small increase in hand-held earth station power may be necessary. Such systems employ Medium Earth Orbit Satellites (MEOS).

### **6.13 FUTURE DIRECTIONS**

Access to hand-held telephone satellite communications with global access will become available. A number of companies are developing systems which employ LEO and MEO satellites. The first system, Iridium, is due to be in operation in 1999.

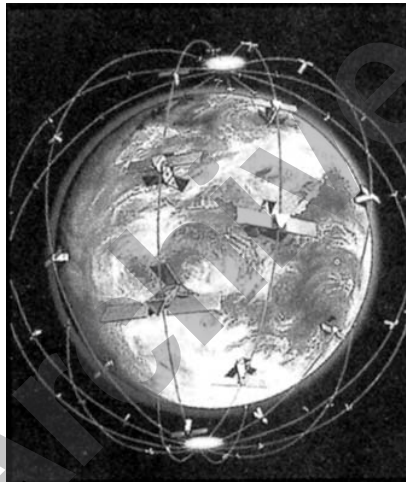

Figure 6:2—Future Satellite Directions

**6.14** Some planned networks propose to employ hand-held digital telephones that will access a conventional terrestrial mobile telephone cell if available or a satellite if a terrestrial cell cannot be accessed, ie they will be dual mode systems.

### **6.15 NAVIGATION SATELLITE SYSTEMS**

The Global Positioning System (GPS) is a space-based navigation satellite system which provides highly accurate signals to ground-based, air and marine receivers which calculate and display positions in latitude and longitude with an accuracy of 100 metres. Although these systems are not communication satellite networks, information from them can be impressed on communication satellite systems to provide position information for such tasks as Automatic Vehicle Location (AVL).

**6.16** Hand-held and mobile GPS receivers are available for navigation. Added features of these units permit the operator to undertake a wide array of navigation tasks.

SECTION 2—ESTABLISHMENT, MAINTENANCE AND OPERATION OF  
COMMUNICATION SYSTEMS AND EQUIPMENT

CHAPTER 7

RADIO COMMUNICATIONS FUNDAMENTALS

INTRODUCTION

7.1 A knowledge of the fundamental principles of radio communications will provide a greater understanding of communications and could enhance effective communications.

RADIO WAVES

7.2 DESCRIPTION

The action of a radio wave cannot be seen but can be likened to ripples caused by a stone being dropped into a pond. The resulting inner wave is high in intensity and then diminishes with distance. The wave action will continue if stones are dropped at regular intervals into the pond. Radio waves behave in a similar way except they usually travel through space rather than water. Radio waves travel at the speed of light in free space (300,000,000 metres per second).

7.3 A RADIO WAVE

A radio wave or one cycle of radio energy can be shown diagrammatically as in Figure 7:1.

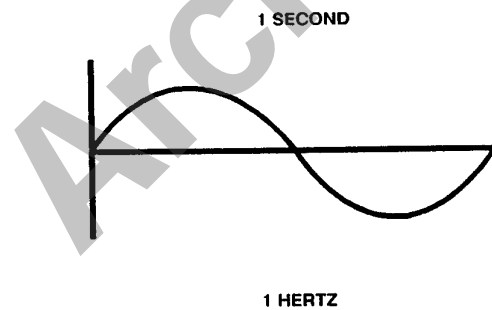

Figure 7:1—Frequency of One Hertz

7.4 WAVE LENGTH

The length of one single wave (or one complete cycle) is also the distance travelled during the transmission of one cycle.

7.5 FREQUENCY

The number of complete waves (or cycles) passing a point in one second is termed 'frequency':

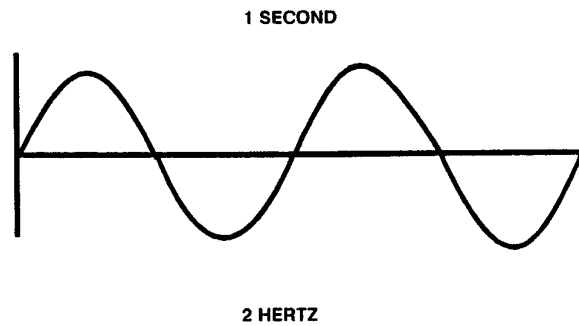

Figure 7:2—Frequency of Two Hertz

- a. One wave per second is a frequency of one HERTZ (Hz).
- b. 1000 waves per second/ Hz is 1 KILOHERTZ (kHz).
- c. 1,000,000 waves per second/Hz is 1 MEGAHERTZ (MHz).
- d. 1,000,000,000 waves per second/Hz is 1 GIGAHERTZ (GHz).

## RADIO FREQUENCY SPECTRUM

7.6 The characteristics of radio signals vary according to frequency and are divided into nominal 'bands' which represent significant changes in performance. The bands are listed below:

| Bands                      | Frequency Range | Uses  |
|----------------------------|-----------------|---|
| Medium Frequency (MF)      | 300 kHz–3 MHz   | AM Broadcast services.  |
| High Frequency (HF)        | 3 MHz–30 MHz    | Short wave broadcast, Royal Flying Doctor, marine services.                         |
| Very High Frequency (VHF)  | 30 MHz–300 MHz  | FM and television broadcasting, two way radio services, aviation.                   |
| Ultra High Frequency (UHF) | 300 MHz–3000    | Two way radio services, television broadcasting, UHF CB, aviation, microwave links. |
| Super High Frequency (SHF) | 3000 MHz–30 GHz | Radar, satellite, telemetry, microwave links.                                       |

## 7.7 OVERLAPPING OF BANDS

The characteristics of radio signals do not change sharply at band edges but gradually alter, eg a 27 MHz signal exhibits characteristics of both HF and VHF.

**SECTION 2—ESTABLISHMENT, MAINTENANCE AND OPERATION OF  
COMMUNICATION SYSTEMS AND EQUIPMENT**

**CHAPTER 8**

**RADIO TRANSMISSION PRINCIPLES, SYSTEMS AND  
EQUIPMENT**

**INTRODUCTION**

- 8.1** This chapter describes radio propagation principles, communication systems, radio transceivers and ancillary equipment in common use with emergency service organisations.

**VERY HIGH FREQUENCY (VHF) AND ULTRA HIGH FREQUENCY  
(UHF) PROPAGATION**

**8.2 LIMITATIONS**

VHF and UHF systems are line of sight operations; if two stations are in visual contact, communications are probable. However, if distance becomes too great, signal strength decreases so that transmissions become too weak to be received. Smoke, bush fires and some types of pollution may also reduce communication distances.

- 8.3** Although line of sight is not achieved, communication from behind objects such as buildings and hills is still possible. Other effects such as reflections and diffraction cause the radio signals to bounce off reflective surfaces or to curve over the top of hills and may allow effective communication to be maintained.

**8.4 DEAD SPOTS**

Reflected signals sometimes combine in such a way to severely reduce signal strengths, resulting in 'dead spots'. These dead spots are often highly localised. Shifting the position of one of the transceivers by as little as a metre, may provide acceptable communication.

**8.5 RANGE**

The nominal range of a VHF or UHF system under ideal operating conditions varies between 50–100 km depending on a number of variables, including antenna height.

**8.6 EMERGENCY SERVICES USE**

Emergency Service Organisations predominantly use equipment in VHF and UHF bands operating in the SIMPLEX (one to one mode over a radio line of sight path), or REPEATER mode. For a detailed explanation of REPEATER operation see the paragraph titled Repeater Base Stations below.

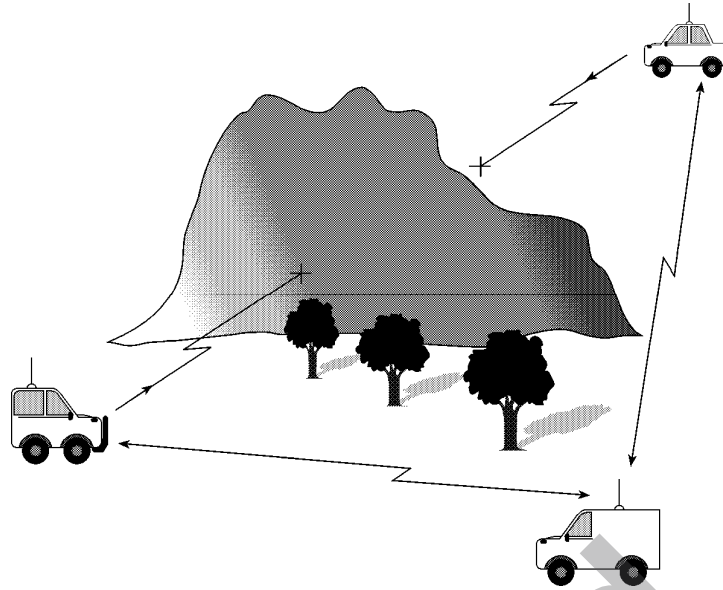

Figure 8:1—VHF/UHF Line of Sight Path

## 8.7 SUPER HIGH FREQUENCY (SHF) PROPAGATION

SHF radio signals operate over line of sight paths. Point-to-point communication services such as microwave links and earth stations for satellite links are the major users of this band.

## VHF/UHF BASE STATIONS

### 8.8 LOCAL CONTROL

To ensure optimum range and provide best line of sight conditions, VHF and UHF base stations need to be located on elevated sites. Where such a site is not available, the antenna system must be installed on a high mast. If the base station and the control unit are jointly located, the configuration is known as a LOCAL CONTROL base station, as shown in the figure below:

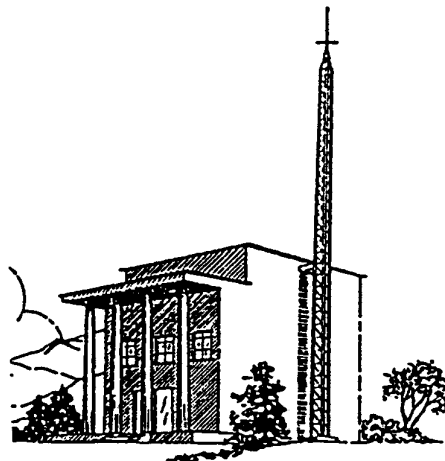

Figure 8:2—VHF/UHF Base Station Local Control

## 8.9 REMOTE CONTROL

Where an extended service area is required and it is not practical to collocate the radio base and its control, the two elements are separated, with the base station being installed at an elevated site and **remotely controlled** via leased landlines, private landlines or a radio link.

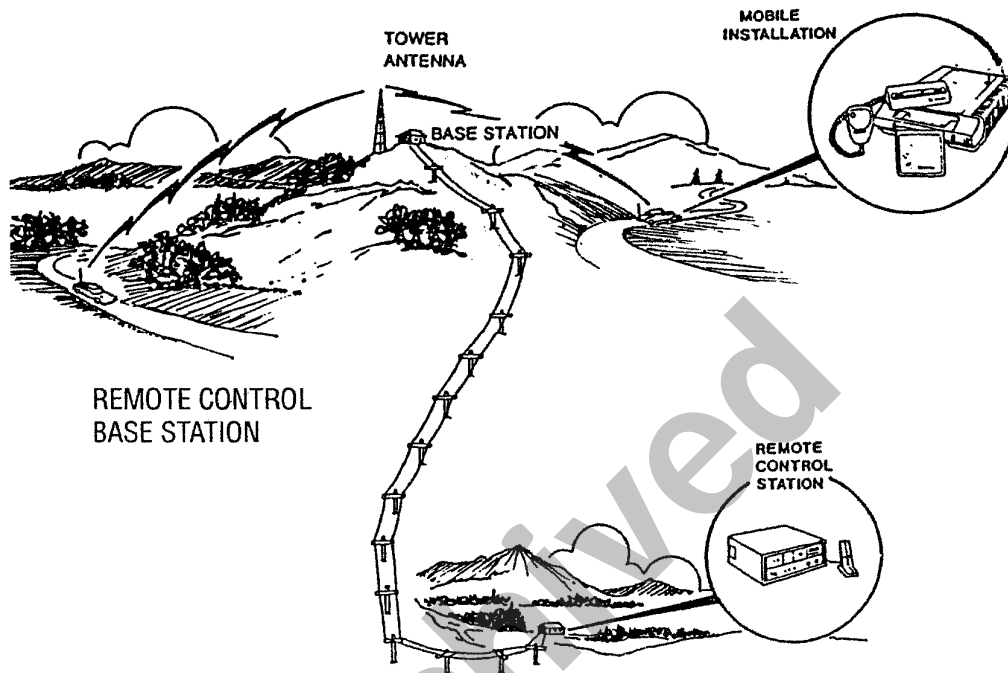

Figure 8:3—VHF/UHF Base Station Remote Control

## 8.10 SIMPLEX OPERATION

When operating a VHF/UHF mobile or portable radio to a base station, the communication path will be between the base station and the mobile/portable radio. Other mobile radios operating on the network may not be heard by all users unless they are in the immediate vicinity. In this situation, transmissions and reception on the same frequency are known as 'simplex operation'. Two frequency simplex is also available.

## 8.11 REPEATER BASE STATIONS

There is virtually no difference in the radio coverage area between a base station or a talk-through repeater base station located at the same site. However, if a manually controlled base station is not practical, and direct mobile to mobile communications is to be maintained then a talk-through repeater base station must be employed.

**8.12** A talk-through repeater base station functions by receiving a signal and simultaneously retransmitting it automatically without intervention of a base station operator. Separate transmit and receive frequencies are necessary to achieve talk-through repeater base station. When communicating to another operator via a repeater, the user is accessing the repeater not the radio at the end of the communication path.

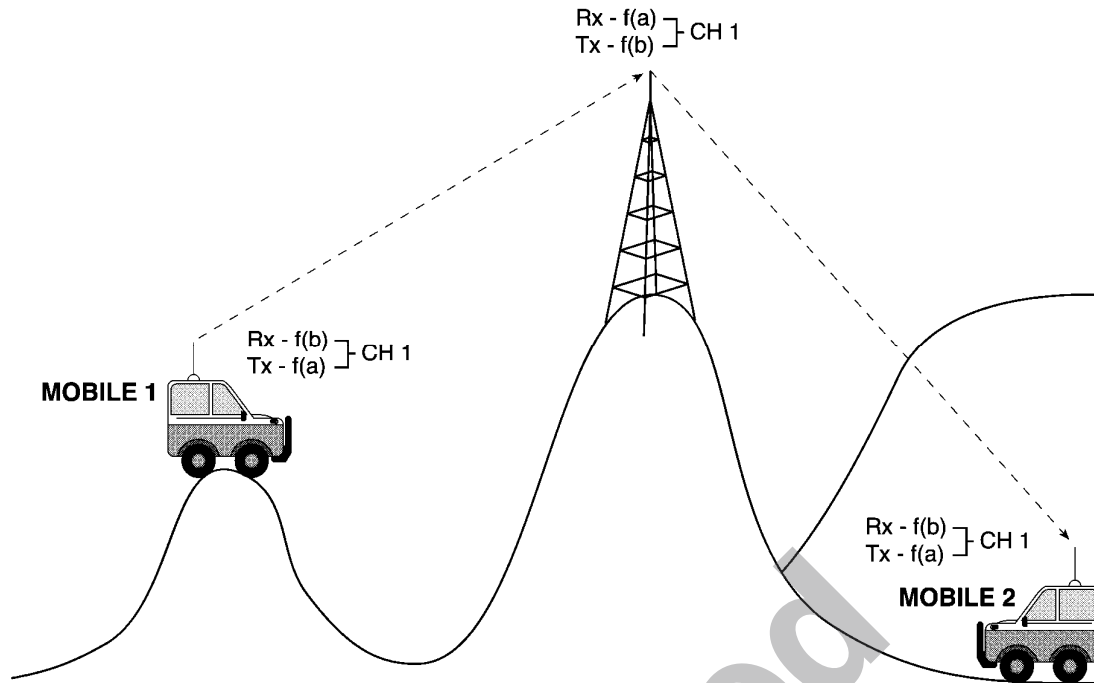

Figure 8:4—Repeater Base Station

### 8.13 PORTABLE RADIO BASE STATION

Base stations including repeaters can operate in a portable configuration. They are normally operated with a portable antenna and mast and are usually powered by portable generator and battery back-up. Such repeaters are temporarily deployed in areas that require enhanced communication facilities. Care must be taken to ensure that these base stations are not located in areas that may cause interference to other radio communication services. Accordingly, portable radio base station equipment should be installed by qualified personnel only.

### 8.14 SCANNING

Most modern radio transceivers are able to automatically switch between channels in sequence when the scan option (if fitted) is selected, ie scan a selection of frequencies. The receiver will pause when encountering an active channel. There are a variety of methods of scanning but the basic concept is that the operator can monitor multiple channels with a single transceiver.

### 8.15 DISADVANTAGE OF SCANNING

A significant disadvantage of scanning is that while the receiver is locked to signals on one channel, messages on other channels may be missed. For this reason, a single radio should not be used in scanning mode during an operation. Where two or more transceivers are used, scanning should be used on one radio only.

### 8.16 TELEPHONE/RADIO INTERFACE

Telephone/radio interface devices permit radio systems to access the PSTN so that personnel in the field can communicate with others on the normal telephone system from their mobile or portable radio. However, unless the radio system is secure, conversations may be heard by other radio users.

## 8.17 TRUNKED RADIO SYSTEMS

As the radio spectrum is of finite size and subject to increasing demands by users, alternative systems are being developed to provide optimum use of the spectrum. One of these systems is 'trunked' radio.

**8.18** Unlike conventional radio, where a group of users are assigned a channel (or channels) permanently, a trunked radio system dynamically allocates a channel to a user as the need arises. Computer technology controls the operation of the radio system and results in reduced delays and more efficient use of the available spectrum. Before the advent of trunked radio, channels often became busy, resulting in excessive waiting time, interruptions and 'transmitted over' communications.

**8.19** Trunked radios provide several channels, or frequencies, for use by users. When a conversation is completed, the channel is made available to other users. Idle channels are available to the system for allocation on demand.

**8.20** Several different protocols are used in trunked radio systems; these are identified by abbreviations and codes, changed as the design is upgraded. Three systems which have been developed are:

|              |  |
|--------------|--|
| <b>TETRA</b> | <b>(Trans European Trunked Radio)</b>                      |
| APCO 25      | (Association of Public Safety<br>Communications Officials) |
| MPT 1327     |  |

**8.21** Trunked radio systems provide the ability to send and receive voice and data efficiently while providing quick access, wide area coverage and a high degree of confidentiality. Access to the public telephone system is available. However, direct access between trunked systems is not possible, nor can a single radio connect to more than one system.

**8.22** The protocols allow several enhancements such as Automatic Vehicle Location (AVL), duress alarm and Global Positioning System (GPS) position correction signals. Most importantly, trunked radio systems usually offer more extensive coverage than private mobile radio networks through a network of strategically located base stations. Networks can be either public, shared or private trunked. A typical trunking system consists of a central control unit and portable (hand-held) or vehicle mounted mobile units. Units can be mixed and matched in any way to suit requirements.



**Archived**

## CHAPTER 9

### HIGH FREQUENCY RADIO OPERATION

#### 9.1 COMPLEXITIES AND VARIABLES

The operation of High Frequency (HF) radio is complex and a number of variable factors can assist or restrict communications. Considerable training and experience is necessary for effective use of HF radio. While VHF and UHF systems are usually employed for line of sight communications, HF remains an effective medium for communication over short, medium and long distances. Distances in excess of 3000 kilometres are within the capabilities of HF radio.

#### 9.2 HIGH FREQUENCY PROPAGATION

HF propagation has two distinct features, **ground wave** and **sky wave**.

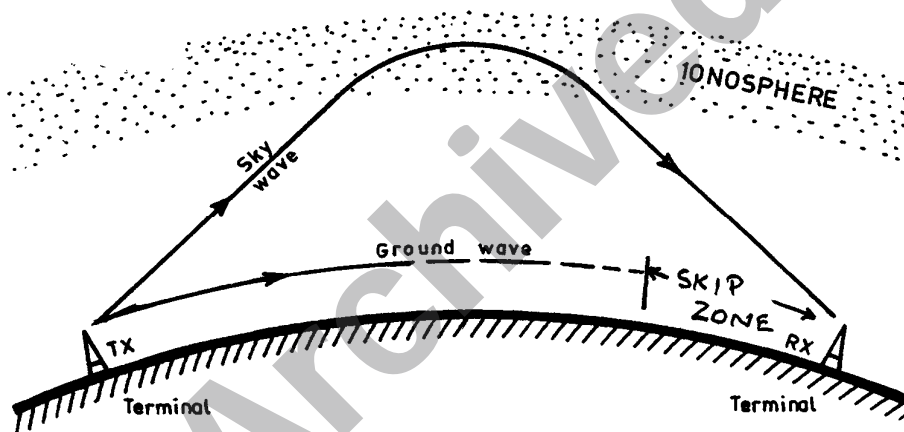

Figure 9:1—HF Propagation

#### 9.3 GROUND WAVE

Some of the energy radiated from the transmitter follows the ground contours and is termed **ground wave**. Ground wave transmissions are usually short range because a significant amount of energy is absorbed by the terrain during transmission. Pure ground wave transmissions are not subject to fading.

#### 9.4 SKY WAVE

The situation with **sky wave** transmissions is totally different. Radio frequency (RF) energy from the transmitter is radiated into the ionosphere which comprises layers of gas surrounding the earth. Gases within these layers are ionised (electrically charged) by radiation from the sun and become conductive causing refraction (or bending) of the signals back towards earth. This allows transmission over considerable distances.

## 9.5 SKIP ZONE

Often there is a gap in the coverage of the transmitter between ground wave and sky wave. This is termed the **skip zone** or **distance** where the signal is too weak to be of any useful purpose. The problems associated with the skip zone may be overcome by relay techniques via a third station that has sky wave communication with both ends of the link. Additional procedures that may assist include changing frequency or changing the type of antenna in use.

## 9.6 SELECTING THE CORRECT FREQUENCY

The ionospheric layers also bend signals at varying degrees depending on the frequency in use. Operating frequencies must be chosen according to the time of the day and the distance of the communication path required. Generally, lower frequencies are more suitable for use at night while higher frequencies are used during the day. The height and density of the ionosphere changes with time of day, season and solar activity, causing fading on HF transmissions. Solar storms can completely disrupt HF transmissions.

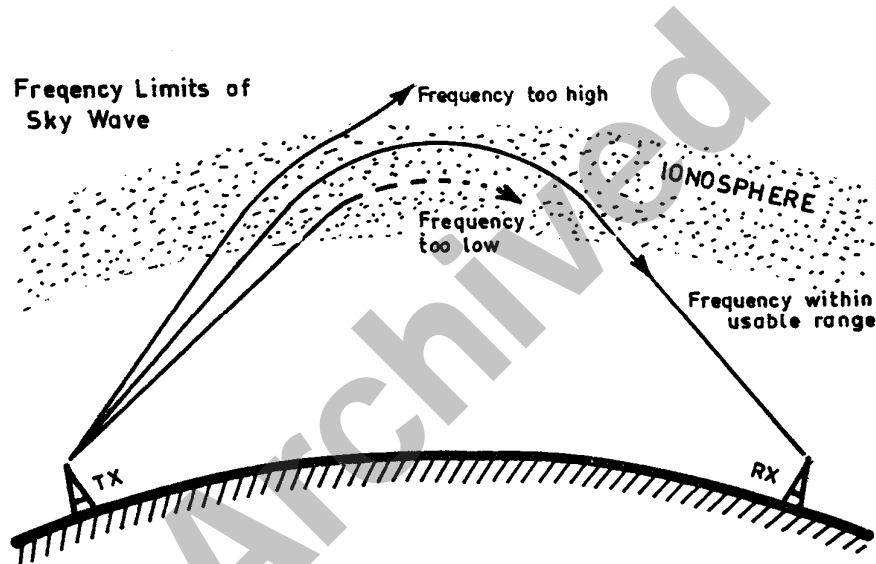

Figure 9:2—Selecting the Correct Frequency

## 9.7 IONOSPHERIC PREDICTION SERVICE (IPS)

The (radio and space) IPS is a Commonwealth Government agency that studies the characteristics of HF transmission and issues predictions on the performance of HF sky wave communications over designated distances and frequencies according to the date and time of day. This service is available on request and may be obtained by telephone.

**9.8** IPS produces a three monthly calculator that indicates the optimum frequency to be used over a given distance at a given time of the day. The agency provides a number of other services including training, warnings of unusual solar activity and a recorded telephone information service that is amended daily. IPS also produce a computer software package (called ASAPS), which is designed to produce predictions for particular paths, date and times.

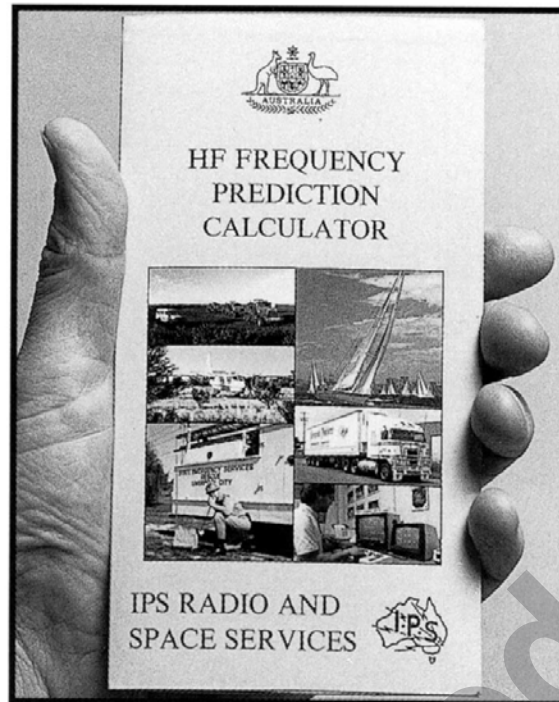

Figure 9:3—Frequency Prediction Calculator

## HF BASE STATIONS

### 9.9 LOCAL CONTROL

Fixed HF radio base stations may be controlled locally or remotely. Locally controlled bases have their transmitter and receiver combined (transceiver) and connected to an external antenna. The transceiver is usually a mobile radio connected to a mains operated 12 volt DC power supply.

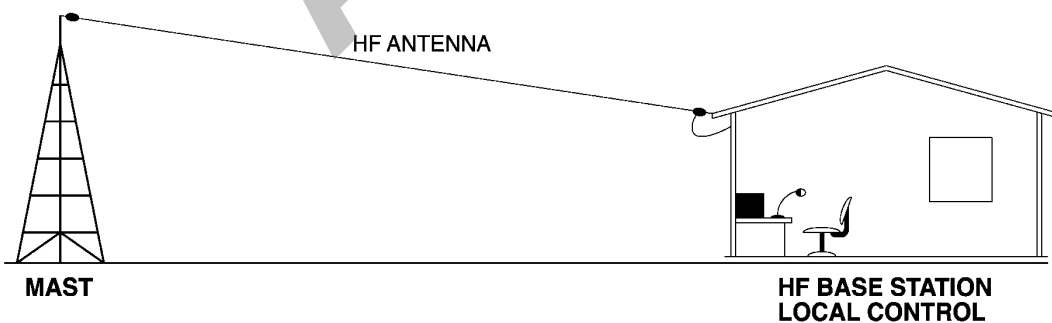

Figure 9:4—HF Base Local Control

### 9.10 REMOTE CONTROL

Due to local electrical noise problems, or difficulty in finding sufficient space for antennas, HF transceivers may be remotely located, but controlled from a central point via leased landlines, private landlines or a radio link.

9.11 When multiple HF services are collocated, it may be necessary to separate transmitters and receivers. This is achieved by installing all transmitters at one site and all receivers at a separate site.

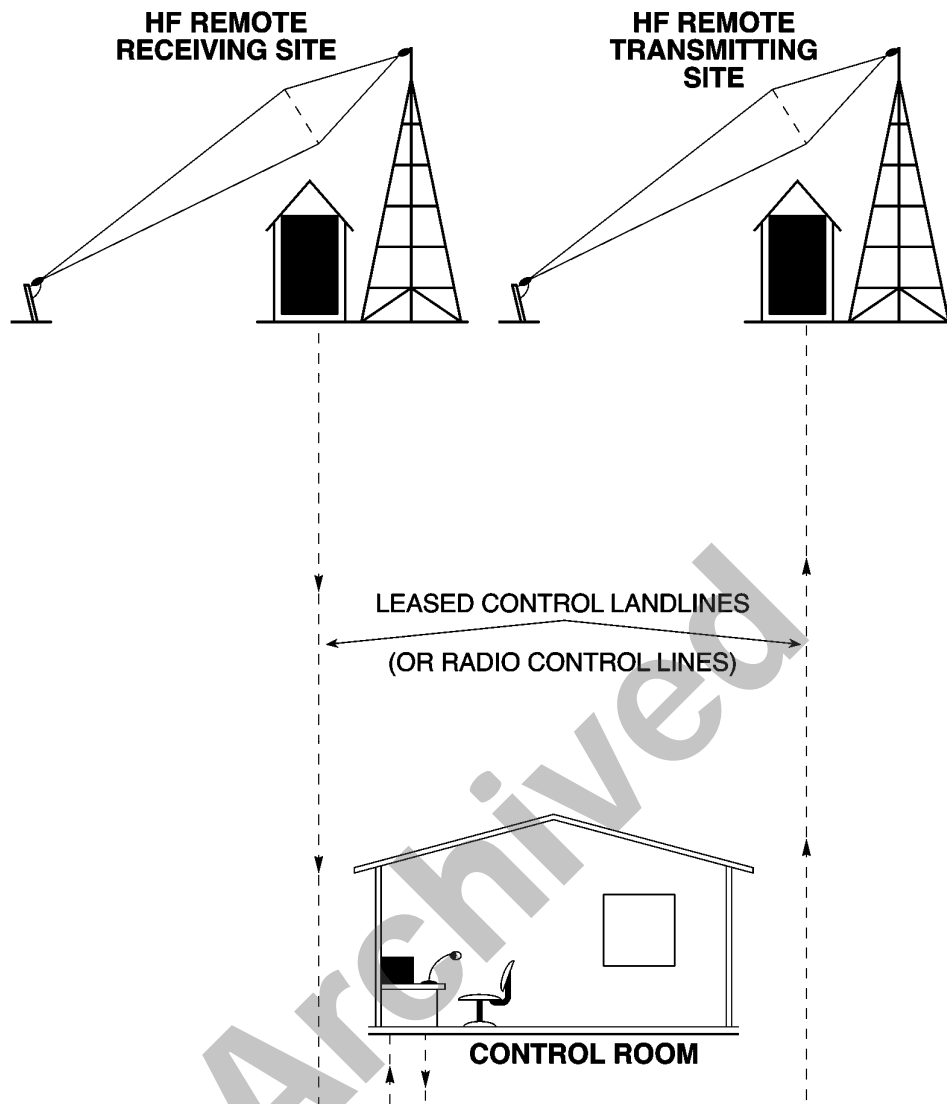

Figure 9:5—HF Base Remote Control with Separate Transmitter and Receiver Sites

## 9.12 STATION SITING

For optimum performance, the following should be considered when siting HF base stations:

- a. They should be located away from sources of electrical noise such as power lines, industry, computers, portable generators.
- b. Sufficient space should be allowed for the erection of antennas with appropriate orientation.
- c. They should be installed in areas with good soil conductivity (moist ground).

## HF MOBILE RADIO COMMUNICATIONS

### 9.13 TRANSCEIVERS

Several problems may be encountered when using HF mobile transceivers to provide communication from vehicles operating in the field as follows:

- a. Proximity to powerlines and other external sources of electrical interference. The problem may be overcome by moving.
- b. Vehicle electrical components including:
  - (1) spark plugs;
  - (2) alternators;
  - (3) oil and fuel sensors;
  - (4) windscreen wiper motors; and
  - (5) engine management computers.

These problems can be largely eliminated by vehicle electrical suppression techniques.

- c. Proximity to other vehicles. This problem may be overcome by re-locating.
- d. Proximity to industrial areas and machines. This problem may be overcome by re-locating to an electrically quieter area; and
- e. Atmospheric conditions, such as thunderstorms or high humidity. This problem may be overcome by changing frequency.

### 9.14 WHIP ANTENNAS

The purpose of the antenna is to transmit and receive a signal efficiently and is a critical part of the HF transceiver in a vehicle. There are two types of HF mobile antennas in common use:

- a. Auto tune antenna. These antennas are tuned automatically according to the frequency selected and is accomplished by the operator from within the vehicle.
- b. The 'Wander Lead' is a critical piece of the antenna in that each whip has a unique length of lead in millimetres which is stamped on the antenna and is measured from plug tip to plug tip. Replacement by longer or shorter leads will degrade the performance of the antenna.

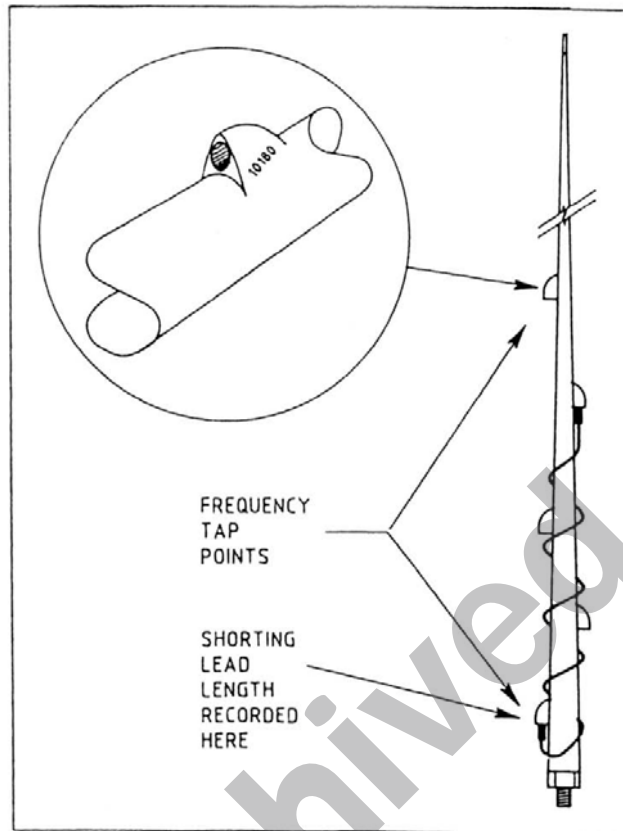

Figure 9:6—Tapped Whip Antenna

### 9.15 PRECAUTIONS

As performance of the equipment will be degraded, operators should ensure no person approaches closer than one metre from the antenna when a HF mobile transceiver is being used. Holding the antenna during transmission may cause skin burns.

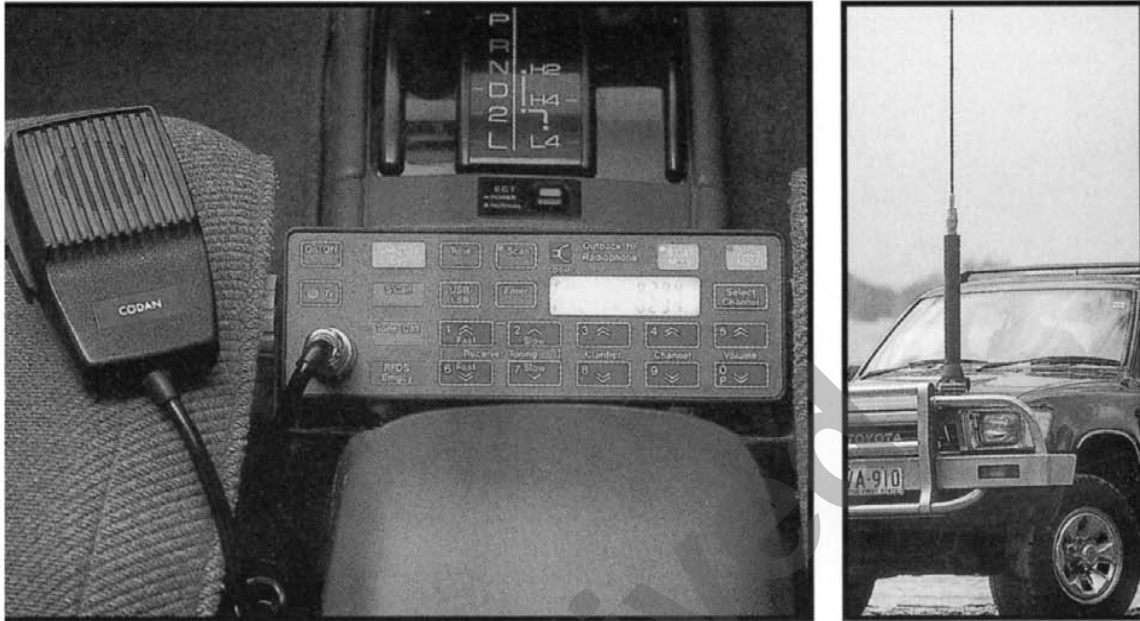

Figure 9:7—Typical HF Mobile Installation

## HF PORTABLE RADIO COMMUNICATIONS

### 9.16 TRANSCEIVERS

HF portable radio transceivers are generally low powered units and consist of a mobile transceiver attached to a rechargeable battery pack, enclosed in a carry case. The antenna can be either a shortened tapped whip, similar to the mobile version, or an external wire antenna.

9.17 If fitted with a tapped whip antenna, the transceiver should be placed on a sheet of metal, space blanket or similar material when it is being operated from the ground. An alternative is to place the transceiver on the bonnet of a vehicle to provide the necessary ground plane (artificial earth).

9.18 An adequate earth is essential for antenna efficiency and can be achieved by a one to two metre earth stake driven into the ground with a wire connected to the radio housing. To ensure a good earth, tip a bucket of salty or bore water around the stake. Alternative sources of liquid should be considered if no water is available.

9.19 When used with an external wire antenna, the performance of the radio is enhanced. An internal antenna tuning unit enables the wire antenna to be tuned to the frequency selected on the radio.

## OPERATING HF RADIOS

### 9.20 BASIC OPERATING STEPS

- a. Switch off the **mute** control if fitted and adjust volume to desired level.



- b. Select the correct operating frequency according to the time of day and communication distance as per IPS or other technical instructions.
- c. Check that the right antenna is connected.
- d. Tune the antenna or select the proper tapping for the frequency required; some antennas are broadband or automatically tuned and do not require adjustment.
- e. Make the call.
- f. If no contact is made or the results are poor, arrange with the other operator to try alternative channels until best communications are achieved.

## **9.21 MODERN HF SELECTIVE CALLING (SELCALL) SYSTEMS**

Selcall is a facility available on modern HF radios which enables noise free operation and allows specific individual radios or groups of radios to be called. Its operation is similar in concept to the use of a telephone, in that the calling radio 'dials' the called radio or group of radios, transmits the code and only those fitted with the Selcall code will respond. All other Selcall fitted radios will remain silent.

**9.22** Each HF radio or group of HF radios may have a unique electronic coded number allocated, known as a Selcall number. The number is transmitted whenever the Selcall button on the radio is depressed.

**9.23** There are a number of coding standards in use in Australia. Care must be taken to ensure that the appropriate standard is used in the radio or selective calling will not take place. The design of the modern Selcall code is based on a number of digits, eg 0001–9999. For further information refer to the operators manual or organisation SOPs. When Selcall and non-Selcall radios are used together, care must be taken to ensure interoperability by disabling the Selcall mute control. However, conventional muting can still be used. A particular advantage of Selcall operation is that it enhances scanning.

**9.24** Other important features of Selcall (but not necessarily available on all systems) are as follows:

- a. Automatic reply (revertive) once contact is made. This gives the calling operator an audible indication that positive contact has been made with the called radio. However this is not a guarantee that voice communications can be achieved.
- b. Absent operator indication, eg alpha-numeric display and/or flashing red light.
- c. Only parties directly involved in the radio conversation need listen to it.

## **9.25 HF BEACONS**

Modern HF radio networks employing Selcall allow the user to judge whether voice communication over a given distance could be successful on selected frequencies. On transmitting a Selcall to a base station, a beacon replies if the signal path is good. If the Beacon does not reply, the signal path is not good and the operator should try another frequency. Refer to the paragraph on the ionospheric predictions at the beginning of this chapter for guidance on correct frequency selection.

**SECTION 2—ESTABLISHMENT, MAINTENANCE AND OPERATION OF  
COMMUNICATION SYSTEMS AND EQUIPMENT**

**CHAPTER 10**

**BASIC RADIO MAINTENANCE**

**RADIO COMMUNICATIONS EQUIPMENT SHOULD BE INSTALLED  
AND SERVICED BY QUALIFIED TECHNICAL PERSONNEL**

**OPERATOR MAINTENANCE**

**10.1** Operators should carry out regular maintenance as follows:

- a. Visual check of all connections.
- b. Regular 'on air' testing.
- c. Keep batteries charged and ensure that dry cells are removed from equipment in storage.
- d. Keep the radio clean, dry and dust free.
- e. Check all accessories.

If a fault is found, the radio should be labelled and the fault described with sufficient information to aid repair and return of the repaired item. Accessory items should also be included.

**FAULT FINDING PROCEDURE**

**10.2 TOTAL FAILURE**

Should the radio fail totally (ie no transmit or receive), the following fault finding procedures should be carried out:

- a. Ensure the radio is switched on and indicator lamps are glowing.
- b. Ensure power leads to battery or power supply are properly connected to the appropriate terminals.
- c. Check fuses in power leads and power supply unit. If replacement is required ensure that the same value fuse is used.
- d. Check antenna and microphone connections. If an external loudspeaker is being used, ensure it is plugged in.
- e. Ensure the radio is switched to an operational frequency.
- f. Check remote head connections, if fitted.

**10.3 RECEIVER FAILURE**

Proceed as follows:

- a. Check volume control setting.
- b. Check microphone/loud speaker connections or external speaker.
- c. Ensure radio is set to an operational frequency.
- d. Check mute control setting (if fitted).
- e. Check antenna is connected and erected.

#### **10.4 TRANSMITTER FAILURE (ASSUMING THE RADIO IS RECEIVING)**

- a. Ensure microphone is connected and the 'Push to Talk' button is working.
- b. Ensure the transmit lamp is glowing when transmitting.
- c. Check power lead connections from power source to radio.

#### **10.5 FAULT FINDING BY SUBSTITUTION**

Minor radio faults may be found and cleared by using the substitution method. This involves substituting suspect components with known good components in a methodical manner, ie replace a suspect faulty microphone with a known good microphone.

### **RADIO BATTERIES—THEIR CARE AND USE**

**10.6** Counter-disaster and many emergency operations are usually conducted in adverse conditions which place heavy reliance upon battery-operated communications equipment. The proper care of batteries is essential if reliable communications using portable radio equipment are to be maintained. Three main types of batteries are in general use: dry cells, gel cells (lead-acid) and nickel cadmium cells.

#### **10.7 DRY CELLS**

Dry cells are commonly used in a variety of battery-powered consumer equipment such as torches, transistor radios and children's toys. The only type of dry cells that should be used in portable radio equipment are the alkaline type. Alkaline cells have a useful shelf-life of about 12 months and should be kept in cool storage. Common alkaline cells are not re-chargeable.

**10.8** All types of dry cells should be removed from equipment before it is placed in storage to avoid damage by leaking batteries. The manufacturer's instructions should always be followed when replacing batteries as incorrect installation can damage the equipment.

#### **10.9 GEL CELLS**

Gel cells are also known as sealed lead-acid batteries and are used in most manpack portable radios. These batteries are rechargeable with relatively slow recharging times of 8 hours being typical. This type of battery must be charged with the specific charger supplied, otherwise severe damage to the equipment can occur.

**10.10** Gel cell batteries have good endurance and are normally capable of operation for about 8 hours before recharging is necessary. Most manpack portable transceivers can be left on charge permanently without causing any damage. It is imperative that radios with flat batteries be placed on charge without delay as gel cells left in a discharged state will suffer severe damage.

**10.11** The replacement of gel cells should only be done by qualified technical personnel under workshop conditions. The major disadvantage of gel cells is their excessive weight.

## 10.12 NICKEL CADMIUM CELLS

Nickel Cadmium batteries, or 'NiCads', are a type of rechargeable battery used on virtually all hand-held portable radios. NiCads have the advantage that they are compact, relatively light and can be fast-charged in about one hour with a suitable battery charger. However, there can be variations in the characteristics of NiCad batteries of different manufacture.

**10.13** To maintain optimum performance these batteries should not be subjected to:

- a. continual overcharging;
- b. complete discharging;
- c. reduced-cycle charging; and
- d. storage in excessively hot or cold locations.

Because the output voltage remains virtually constant until the batteries are almost discharged, little warning of battery failure is given.

**10.14** When a NiCad battery is partially discharged and recharged for a number of cycles, the batteries charged capacity is severely reduced in direct relation to the number of charge/discharge cycles. For example, if a 10-hour battery is discharged for one hour and then recharged for a significant number of cycles, the battery may develop a shortened, full-charge capacity of only one hour. This is called 'memory effect' and can be overcome by almost fully discharging the battery and recharging it for a number of cycles. This is known as conditioning and automatic chargers/conditioners are available and recommended to extend the life of NiCad batteries.

**10.15** Batteries that give an indication of extreme heat during the charging process are likely to be damaged and become unusable. A timer on the power outlet is recommended to control the charging process. Stored batteries should be charged/discharged on a regular basis, eg every four to six weeks.

**10.16** Environmental and safety considerations should be considered when disposing of batteries. The supplier/manufacturer's advice should be sought on disposal of batteries.

**Note:** To maintain maximum battery life, the manufacturers instructions on charging and discharging should be followed.

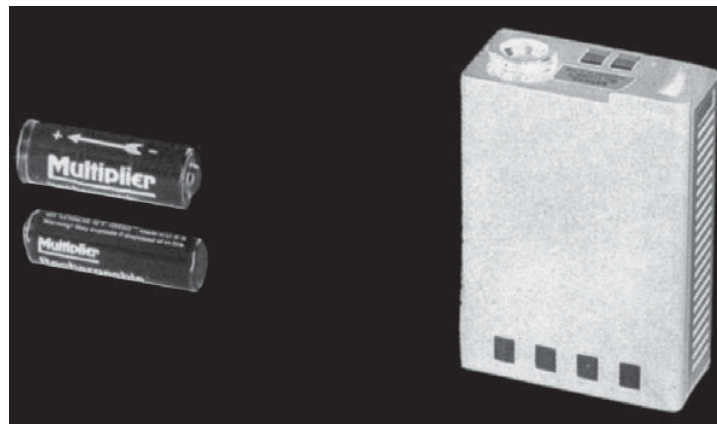

Figure 10:1—Nickel Cadmium Batteries

**Archived**

SECTION 2—ESTABLISHMENT, MAINTENANCE AND OPERATION OF  
COMMUNICATION SYSTEMS AND EQUIPMENT

CHAPTER 11

RADIO OPERATING PROCEDURES

INTRODUCTION

11.1 Whilst the standard radio operating procedure detailed in Section 1 would normally be adequate for efficient message transmission over good quality radio circuits, additional standard procedures are necessary for the efficient exchange of messages over poor quality radio networks.

11.2 PREREQUISITE

A full understanding of the information contained in Section 1 is necessary before reading this chapter. Some subjects in this section have been covered briefly in Section 1 and are covered again in more detail for the benefit of the advanced radio operator.

11.3 RADIO NETWORKS

A typical radio network diagram appears below. Note that:

- a. VKX777 is the network call sign,
- b. only the station call sign is to be shown inside the circle,
- c. Curtin Base is the control station, and
- d. the network control station is always shown at the bottom of the fan.

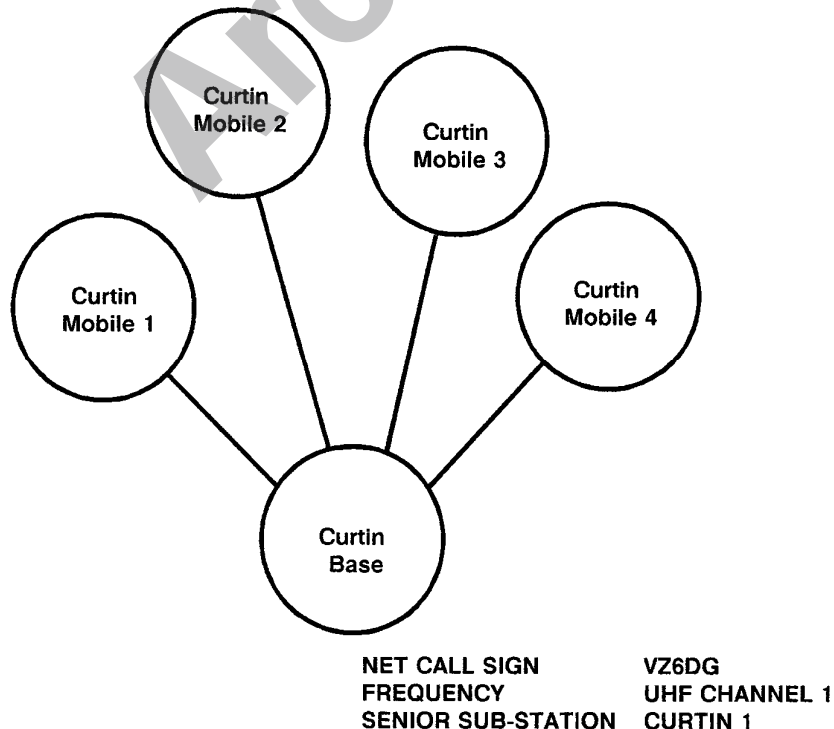

Figure 11:1—Radio Network

## 11.4 NETWORK DISCIPLINE

To function effectively, radio networks need to be operated in a disciplined manner. Good network discipline requires that correct operating procedures be used so that control is maintained. Networks that suffer a loss of discipline degenerate to the point where they are unable to carry useful message traffic. Where network discipline has failed, the **control station** must intervene and instruct all stations to cease transmission until called. The **control station** then re-establishes the network ensuring that the previous improper procedures are eliminated.

## TRAFFIC

**11.5** Traffic is a general term given to all communications which are handled on a network. There are two types of traffic, formal and informal.

### 11.6 FORMAL TRAFFIC

Formal traffic is written, released by an authorised officer and recorded by the communications centre (COMCEN). It includes:

- a. registered messages, including Situation Reports and Monitor Reports;
- b. facsimile messages; and
- c. telex messages.

### 11.7 INFORMAL TRAFFIC

Informal traffic does not require recording by the COMCEN and is not traceable; it includes:

- a. conversations; and
- b. unregistered messages.

## CALLING AND ANSWERING

### 11.8 INTRODUCTION

The following paragraphs contain examples of calling and answering procedures:

- a. Prowords Used:

THIS IS

OVER

OUT

WAIT

WAIT OUT

WILCO

ROGER

- b. Parts of a Call—A call consists of the following parts:

NET CALL SIGN—Identifies the net.

STATION CALL SIGN—Identifies the station(s) being called

THIS IS—Proword. Preceding calling station's call sign.

STATION CALL SIGN—Identifies the calling station.

TEXT—The message itself.

ENDING SIGN—'OVER'—the proword used to indicate that the transmission has ended, but further transmissions are expected from other station(s).

Example of a Call:

VKX777 Curtin 1 THIS IS Curtin Base move now OVER.

- c. Parts of an Answer—The answer consists of the following parts:

STATION CALL SIGN—Identifies station answering. TEXT—

Answer, or receipt.

ENDING SIGN—OVER—End of my transmission—I expect a reply.

OUT—Proword to indicate that the station expects no further involvement in that call.

WAIT—Proword indicating that the receiving operator must pause during the transmission.

WAIT OUT—Proword indicating that the receiving operator must delay transmission for more than five (5) seconds and will resume later with an initiating call.

Example of an answer:

Curtin 1 WILCO OUT

- d. The above procedures are known as Abbreviated Procedures and are used in good working conditions. Full Procedures are used in difficult working conditions and are explained later in this Manual.

## TYPES OF CALLS

### 11.9 SINGLE CALL

A single call occurs between any two stations on the net. All call signs may be omitted after the initial call and reply.

Example:

Curtin Base says: 'VKX777 Curtin 1 THIS IS Curtin Base have your ropes arrived OVER'

Curtin 1 says: 'Curtin 1 No when did they leave OVER'

Curtin Base says: 'FIGURES 20 minutes ago OVER'

Curtin 1 says: 'ROGER OUT'

### 11.10 MULTIPLE CALL

- a. Multiple calls are used when one station wishes to call two or more stations on the net, but not all stations.
- b. Stations are called in alpha-numeric order and they answer in the same order. Should a station fail to answer, the next station in sequential order shall pause 5 seconds and then reply as normal. After the last station has replied, the station, which previously failed to answer, may reply.



Example: Base calling four sub-stations of a seven station net.

Curtin Base says: 'VKX777 Curtin 1 Curtin 2 Curtin 3 Curtin 4 THIS IS Curtin Base, fresh batteries are available at FIGURES 0900 hours OVER'

Curtin 1 says: 'Curtin 1 ROGER OUT'

Curtin 2 says: 'Curtin 2 ROGER OUT'

Curtin 3 says: 'Curtin 3 ROGER OUT'

Curtin 4 says: 'Curtin 4 ROGER OUT'

**Note:** As this a Multiple Call, call signs must continue to be used after the initial call and reply.

#### **11.11 NET CALL OR ALL STATIONS CALL**

These types of calls are used to call all stations on the net; stations reply in alpha-numeric order. The same rules apply as with multiple calls.

Example: The net consists of four stations.

Curtin Base says: 'VKX777 all stations THIS IS Curtin Base tarpaulins are now available OVER'.

Curtin 1 says: 'Curtin 1 ROGER OUT'

Curtin 2 says: 'Curtin 2 ROGER OUT'

Curtin 3 says: 'Curtin 3 ROGER OUT'

Curtin 4 says: 'Curtin 4 ROGER OUT'

Curtin Base says: 'Curtin BASE ROGER OUT'

#### **11.12 ALL STATIONS EXCEPT CALL**

If only the majority of Stations are to be called, Curtin Base may use: All Stations except ..... procedure.

Example:

Curtin Base says: 'VKX777 ALL STATIONS except Curtin 4 THIS IS Curtin Base Tarpaulins are now available OVER'

Curtin 1, Curtin 2 etc. reply in sequence.

### **ESTABLISHING A RADIO NET**

#### **11.13 RADIO CHECK AND SIGNAL STRENGTH CALLS**

Prowords used are:

RADIO CHECK

NOTHING HEARD

ROGER

LOUD

GOOD

WEAK

VERY WEAK

FADING CLEAR  
READABLE  
DISTORTED  
INTERFERENCE  
UNREADABLE  
SIGNAL STRENGTHS

#### 11.14 INITIAL PROCEDURE

The procedure to establish a radio network is to ensure that all stations on the net are able to communicate with each other on the same frequency. Before any station leaves its HQ, the members of that station must know the:

- a. primary net frequency;
- b. alternative net frequency, if any;
- c. organisation of the net;
- d. time the net is to open;
- e. net call sign;
- f. station call signs; and
- g. senior sub-station.

**Note:** At all times, sub-stations should establish communications with the net control station as they leave the base.

#### 11.15 RADIO CHECKS (SIGNAL STRENGTHS AND READABILITY)

- a. The net control station establishes the net by ordering sub-stations to report the strength and readability of its signal by using the proword RADIO CHECK, which means 'What is my signal strength and readability?' The sub-stations answer the call in turn giving their report of signal strength and readability of the control station. The control station will complete the call by informing sub-stations of their signal strength and readability. If the answer is LOUD and CLEAR, the proword ROGER will suffice.

- b. The following prowords are for use when initiating and answering queries concerning signal strength and readability:

RADIO CHECK—What is my signal strength and readability, that is, how do you hear me?

ROGER—The use of the proword ROGER in reply to a radio check means the transmission was satisfactory. This will save air time. ROGER replaces loud and clear.

SIGNAL STRENGTHS—What is the signal strength and readability of all the other stations on the net. Each sub station will say how it hears all the other sub-stations.

#### 11.16 REPORT OF SIGNAL STRENGTHS

- a. LOUD—Your signal is very strong.
- b. GOOD—Your signal is good.

- c. WEAK—Your signal is weak.
- d. VERY WEAK—Your signal is very weak.
- e. FADING—At times your signal fades to such an extent that continuous reception cannot be relied upon.

#### **11.17 REPORT OF READABILITY**

- a. CLEAR—Excellent quality.
- b. READABLE—Quality is satisfactory. This proword may be used with the proword DISTORTED or INTERFERENCE.
- c. DISTORTED—Having trouble reading you because your signal is distorted.
- d. INTERFERENCE—Having trouble reading you due to interference.
- e. UNREADABLE—The quality of your transmission is so bad that I cannot read you.

#### **11.18 EXAMPLES OF TRANSMISSIONS TO ESTABLISH THE NET**

- a. When all stations are LOUD and CLEAR (ROGER).  
 Curtin Base says: 'VKX777 all stations this is Curtin Base RADIO CHECK OVER'  
 Curtin 1 says: 'Curtin 1 ROGER OVER'  
 Curtin 2 says: 'Curtin 2 ROGER OVER'  
 Curtin 3 says: 'Curtin 3 ROGER OVER'  
 Curtin 4 says: 'Curtin 4 ROGER OVER'  
 Curtin 5 says: 'Curtin 5 ROGER OVER'  
 Curtin Base says: 'Curtin BASE all stations ROGER OUT'
- b. When some of the stations are not receiving clearly:  
 Curtin Base says: 'VKX777 all stations THIS IS Curtin Base RADIO CHECK OVER'  
 Curtin 1 says: 'Curtin 1 ROGER OVER'  
 Curtin 2 says: 'Curtin 2 ROGER OVER'  
 Curtin 3 says: 'Curtin 3 WEAK BUT READABLE OVER'  
 Curtin 4 says: 'Curtin 4 ROGER OVER'  
 Curtin 5 says: 'Curtin 5 LOUD WITH INTERFERENCE OVER'  
 Curtin Base says: 'Curtin BASE all stations ROGER OUT'
- c. When requesting a radio check, the originating station, after the other stations have replied, will in its reply give a radio check to other stations.

#### **11.19 SIGNAL STRENGTH REPORTS**

Signal strength reports may be requested by any station, but normally by the net control station. The signal strength report will inform each station how they are being received by all other stations on the net. The signal strength report is usually preceded by a radio check.

Example: (after the above radio check).

Curtin Base says: 'VKX777 all stations THIS IS Curtin Base SIGNAL STRENGTHS OVER'

Curtin 1 says: 'Curtin 1 all stations ROGER OVER'

Curtin 2 says: 'Curtin 2, Curtin Base WEAK BUT READABLE, Curtin 1 ROGER, Curtin 3 WEAK BUT READABLE, Curtin 4 ROGER, Curtin 5 ROGER OVER'

Curtin 3 says: 'Curtin 3, Curtin Base WEAK AND DISTORTED, Curtin 1 GOOD AND DISTORTED, Curtin 2 WEAK WITH INTERFERENCE, Curtin 4 ROGER, Curtin 5 LOUD AND DISTORTED OVER'

Curtin 4 says: 'Curtin 4, all stations ROGER OVER'

Curtin 5 says: 'Curtin 5, Curtin BASE LOUD WITH INTERFERENCE, all other stations ROGER OVER'

Curtin Base says: 'Curtin Base all stations ROGER OUT'

## 11.20 SIGNAL STRENGTH REPORT FORM

Signal strength reports are normally recorded on a form, an example of which is shown below. This form is particularly useful for selecting relay stations eg. CURTIN 4 could be selected to relay to CURTIN BASE for CURTIN 5.

| CALL SIGN   | CURTIN BASE | CURTIN 1 | CURTIN 2 | CURTIN 3 | CURTIN 4 | CURTIN 5 |
|-------------|-------------|----------|----------|----------|----------|----------|
| Curtin Base |             | R        | R        | R        | R        | R        |
| Curtin 1    | R           |          | R        | R        | R        | R        |
| Curtin 2    | W/R         | R        |          | W/R      | R        | R        |
| Curtin 3    | W/D         | G/D      | W/I      |          | R        | L/D      |
| Curtin 4    | R           | R        | R        | R        |          | R        |
| Curtin 5    | L/I         | R        | R        | R        | R        |          |

Figure 11:2—Signal Strength Report

### Notes:

1. The station compiling the report fills in the columns.
2. The above report is for the radio check and signal strength reports as given above.

## 11.21 SCHEDULED CALLS

Radio schedules are established and maintained for the following purposes:

- a. To ensure that all stations on a radio network are in communication. The scheduled call should be initiated from Control and conducted at predetermined intervals.
- b. Transmission of non-urgent messages at intervals during a 24 hour period instead of the operator having to maintain a continuous listening watch.

## TRANSMISSION OF INFORMATION

### 11.22 PROWORDS

Prowords used are:

MESSAGE

LONG MESSAGE

SITREP

SEND

MORE TO FOLLOW

ALL AFTER

OUT TO YOU

### 11.23 UNWRITTEN INFORMATION

Information, which does not have to be written down, may be sent without using a proword in the initial transmission (called an offer) if the sending station is reasonably sure that the recipient is ready to receive it.

Example:

Curtin Base says: 'VKX777 Curtin 1 THIS IS Curtin Base. Go to the airport for your stores, OVER'

Curtin 1 says: 'Curtin 1, WILCO OUT'

### 11.24 WRITTEN INFORMATION

Use of the proword 'MESSAGE' in the offer indicates that the information must be written down. This may apply to information, which contains figures, unusual words, grid references etc. The information must be sent at writing speed to enable the recipient to write it down. The sending station will achieve this aim by:

- a. ghost writing over the information while sending; or
- b. pausing between phrases.

Example:

Curtin Base says: 'VKX777 Curtin 1 THIS IS Curtin Base MESSAGE OVER'

Curtin 1 says: 'Curtin 1 SEND OVER'

Curtin Base says: 'Move to Grid 242 691 OVER'

Curtin 1 says: 'WILCO OUT'

## 11.25 LONG MESSAGE PROCEDURE

If the information will take more than thirty seconds to send, or is longer than 15 words, the following procedure should be used:

- a. The information is offered using the proword LONG MESSAGE.
- b. The information is to be sent in segments, each lasting 15 words or approximately thirty seconds. Remember 'I SPELL', 'FIGURES' and other prowords are included in this rule.
- c. Each segment, except for the last segment, is to terminate with the proword 'MORE TO FOLLOW OVER'.
- d. When segmenting a written message prior to offering, the initiating station must ensure that the end of each segment does not end with:  
phonetics (eg I spell BRAVO);  
phonetically-spelt words (eg alloy I SPELL ALPHA LIMA LIMA OSCAR YANKEE, alloy); and  
figures or punctuation.
- e. Receiving stations are to acknowledge each segment with ROGER OVER or, if necessary, ask for repetitions.
- f. After obtaining receipts for each segment from all receiving stations the sender must pause for five seconds. This will allow other stations to interject for any urgent traffic transmissions.
- g. The station initiating a long message may interrupt its transmission to send a more urgent one.
- h. If there is no interjection the calling station transmits the last word or phrase contained in the previous segment and proceeds immediately with the new segment.
- i. When the calling station completes the last segment of the message, the proword OVER is used. Recipients who have successfully received the whole message then respond with ROGER OUT.

**Note:** Accuracy and speed are the basic essentials for all communications.

## 11.26 EXAMPLE OF LONG MESSAGE

Curtin Base has a long message for Curtin 1 and says: 'VKX777 Curtin 1 THIS IS Curtin Base LONG MESSAGE OVER'

Curtin 1 says: 'Curtin 1 SEND OVER'

Curtin Base says: 'Blankets located in store at Grid 674 395, Some are unserviceable MORE TO FOLLOW OVER'

Curtin 1 requires no corrections or repetitions and says: 'ROGER OVER'

Curtin Base observes a 5 second pause to allow any urgent messages to be passed then continues 'Unserviceable due to water damage full stop transport has been arranged for good blankets tomorrow OVER'

Curtin 1 has received the message and ends the transmission by saying. 'ROGER OUT'

## **CORRECTIONS AND REPETITIONS**

### **11.27 PROWORDS**

Prowords used are:

CORRECTION

SAY AGAIN

ALL AFTER

ALL BEFORE

WORD AFTER

WORD BEFORE

FROM \_\_\_\_\_

TO \_\_\_\_\_

SPEAK SLOWER

UNKNOWN STATION

### **11.28 CORRECTION DURING TRANSMISSION**

The procedure is as follows:

- a. When an error is made by a transmitting operator, the proword 'CORRECTION' is to be transmitted followed by the last word, group, proword or phrase correctly transmitted; the transmission then continues. Care should be taken to avoid using words or prowords which appear more than once in the message.

Example:

Curtin Base says: 'VKX777 Curtin 1 THIS IS Curtin Base move to your last CORRECTION your first location OVER'

Curtin 1 says: 'Curtin 1 WILCO OUT'

- b. When an error in transmission is made and is not discovered immediately, but is discovered before the ending proword 'OUT' is transmitted, a correction is to be transmitted as per the example below. When making such a correction, the word, group, proword or phrase, before or after the correction, is to be properly identified.

Example:

Curtin 1 says: 'VKX777 Curtin 1 THIS IS Curtin Base stores will arrive in figure 6 trucks from Carnarvon CORRECTION WORD BEFORE trucks figure 7 OVER'

Curtin Base says: 'Curtin 1 ROGER OUT'

### **11.29 CORRECTION AFTER A MESSAGE HAS BEEN SENT**

Used if it is necessary to make corrections after a receipt has been obtained for a message. A further message identifying the original, and the portion to be corrected, must be sent.

Example:

Curtin Base says: 'VKX777 Curtin 1 THIS IS Curtin Base reference my message on trucks CORRECTION ALL AFTER trucks from Carnamah OVER'

Curtin 1 says: 'Curtin 1 ROGER OUT'

**Notes:**

1. Curtin 1 must correct the original message and ensure that the correction is passed to all personnel to which the station is responsible; and
2. when the text of a MESSAGE to a number of stations (multiple and net calls) is found to be incorrect all stations must be called and the corrections transmitted.

**11.30 REPETITIONS**

- a. When words are missed or are in doubt, repetitions are to be requested and given to the affected receiving station before receipting the message. The proword SAY AGAIN can be used alone or in conjunction with others.
- b. In complying with requests for repetitions, the initiating (sending) station is to identify that portion which is being repeated and sent using the proword 'I SAY AGAIN'. With messages less than ten words, it is quicker to send the whole message than part of it.

Example:

Curtin Base says: 'VKX777 Curtin 1 THIS IS Curtin Base stores will arrive in figures 7 trucks from Carnamah at noon on Monday OVER'

Curtin 1 says: 'Curtin 1 SAY AGAIN ALL AFTER noon OVER'

Curtin Base says: 'I SAY AGAIN, WORDS AFTER, noon on Monday, OVER'

Curtin 1 says: 'ROGER OUT'

**11.31 SPEED OF TRANSMISSION**

When a receiving station has difficulty in recording a written message because the sending operator is speaking too rapidly, the receiving operator must request a reduction in the speed of transmission by the use of the proword 'SPEAK SLOWER'.

**11.32 UNKNOWN STATION**

When a station hears a call for itself, but has missed the call sign, it may ask for a repetition of the call sign.

Example:

Curtin Base says: 'VKX777 Curtin 1 THIS IS \_\_\_\_\_ OVER'

Curtin 1 says: 'UNKNOWN STATION THIS IS Curtin 1, SAY AGAIN call sign OVER'

Curtin Base says: 'Curtin 1 THIS IS Curtin Base I SAY AGAIN call sign Curtin Base OVER'

Curtin 1 says: 'ROGER OVER'

Curtin Base will now send the message as normal.



## VERIFICATIONS AND CANCELLATIONS

### 11.33 PROWORDS

Prowords used are:

VERIFY

I VERIFY

WAIT OUT

DISREGARD

CANCEL

### 11.34 VERIFICATIONS

When a station receives a message from another station, which it has reason to doubt or suspect may be incorrect, the receiving station should ask for a verification of the message. When a verification has been requested the sending station must take the message to be verified to the originator (author) of the message for that person to authenticate or correct as necessary.

Example:

Curtin Base says: 'VKX777 Curtin 1 THIS IS Curtin Base reference your stores request VERIFY figures 200 stretchers OVER'

Curtin 1 says: 'Curtin 1 wait OUT'

The operator at Curtin 1 must check with the message originator to establish that the message is correct.

If Correct:

Curtin 1 says: 'VKX777 Curtin Base THIS IS Curtin 1 reference the stores request I VERIFY figures 200 stretchers OVER'

Curtin Base says: 'Curtin Base ROGER OUT'

If Incorrect:

Curtin 1 says: 'VKX777 Curtin Base THIS IS Curtin 1 reference the stores request CORRECTION figures 300 stretchers OVER'

Curtin Base says: 'Curtin Base ROGER OUT'

**Note:** If the message has been found to be incorrect and the original message has been sent to more than one station, all stations must be informed of the correction.

### 11.35 CANCELLING TRANSMISSIONS AND MESSAGES

#### a. Cancelling During Transmission:

During a transmission, but prior to the ending proword, a transmission may be cancelled by the use of the proword 'DISREGARD THIS TRANSMISSION, OUT'

#### b. Cancelling an Immediate Past Transmission:

Curtin Base says: 'VKX777 Curtin 1 THIS IS Curtin Base CANCEL my last transmission OVER'

Curtin 1 says: 'Curtin 1 ROGER OUT'

- c. Cancelling a Previous Transmission:

Curtin Base says: 'VKX777 Curtin 1 THIS IS Curtin Base CANCEL my stores request OVER'

Curtin 1 says: 'Curtin 1 ROGER OUT'

## MISCELLANEOUS PROCEDURES

### 11.36 PROWORDS

Prowords used are:

FETCH (name)

WAIT OUT

SPEAKING

### 11.37 ARRANGING A PERSON TO PERSON CONVERSATION

- a. If there is a requirement for one station to speak to a specific individual (not the operator) at another station, the procedure is arranged by the operators using the following prowords:

FETCH (name)—Meaning the person indicated is to be called to speak on the radio.

WAIT OUT—Used by the receiving operator to allow time to arrange for the called person to be present.

SPEAKING—Used by the called person when replying.

Example:

Curtin Base wishes to speak to the Coordinator at Curtin 1.

Curtin Base says: 'VKX777 Curtin 1 THIS IS Curtin Base FETCH Coordinator OVER'

Curtin 1 says: 'Curtin 1 WAIT OUT'

Curtin 1 will now bring the coordinator to the radio and brief him on its operation.

Curtin 1 says: 'VKX777 Curtin Base THIS IS Curtin 1 Coordinator SPEAKING OVER'

Curtin Base says: Curtin Base replies.....

- b. The person to person call is arranged by the two radio operators. They must ensure that the individuals for whom they are arranging the call know how to operate the radio sets prior to providing them with the service, ie able to use the Push To Talk Switch etc.

## CHANGING FREQUENCY

### 11.38 PROWORDS

Prowords used are:

CHANGE TO

CHANGE NOW

WILCO

### 11.39 PROCEDURE

Where more than one frequency is available on a radio system, occasions may arise when a change of frequency is desirable. The order to change frequency is given simply by quoting the channel number on VHF and UHF or by quoting the frequency in kilohertz on HF and using the prowords CHANGE TO and CHANGE NOW.

Example:

Curtin Base says: 'VKX777 All stations THIS IS Curtin Base CHANGE TO channel 4 OVER'

Curtin 1 says: 'Curtin 1 WILCO OVER'

Curtin 2 says: 'Curtin 2 WILCO OVER'

Curtin 3 says: 'Curtin 3 WILCO OVER'

Curtin Base says: 'All stations THIS IS Curtin Base CHANGE NOW OUT'

If all stations do not respond or cannot comply, the control station must make alternative arrangements for the change and advise the whole net. A radio check will now be carried on the new frequency.

## CLOSING DOWN

### 11.40 PROWORDS

Prowords used are:

CLOSE DOWN

CLOSE DOWN NOW

WILCO

**Note:** No station should close down, or leave the radio, even only for a few minutes, without prior permission from the net control station.

### 11.41 PROCEDURE

The net control station must ensure that no net individual sub-station is closed down until the net control station is absolutely sure that the net or sub-station is no longer required. The usual practice for closing down sub-stations is to wait until they return to base and individually close them down thus ensuring the safety of teams in the field. If communications are to be reopened at a later time, the net control station must ensure that everyone concerned is aware of the time communications are to be re-opened, and the frequency to be used, before it closes the stations down.

**11.42** When the time to order a close down over the radio arrives, and all stations are satisfied regarding arrangements for re-opening, the net control station orders the net or sub-stations to close down. The net control station may do this by using the proword 'CLOSE DOWN'.

Example 1:

Curtin Base says: 'VKX777 all stations THIS IS Curtin Base CLOSE DOWN OVER'

Curtin 1 says: 'Curtin 1 WILCO OVER'

Curtin 2 says: 'Curtin 2 WILCO OVER'

Curtin 3 says: 'Curtin 3 WILCO OVER'

The control station records each response and, if satisfied that all stations have replied and there is no further traffic, transmits.

Curtin Base says: 'VKX777 all stations THIS IS Curtin Base CLOSE DOWN NOW OUT'

Example 2:

The net control station transmits to all stations to close down and gives reopening directions.

Curtin Base says: 'VKX777 all stations THIS IS Curtin Base CLOSE DOWN. The net will reopen at figures 0800 hours tomorrow on this frequency OVER'

Curtin 1 says: 'Curtin 1 WILCO OVER'

Curtin 2 says: 'Curtin 2 WILCO OVER'

Curtin 3 says: 'Curtin 3 WILCO OVER'

Curtin Base says: 'VKX777 all stations THIS IS Curtin Base CLOSE DOWN NOW OUT'

## **DIFFICULT WORKING CONDITIONS**

### **11.43 CAUSES**

Difficult working conditions may be caused by:

- a. excessive noise;
- b. fading;
- c. unintentional interference;
- d. sharing frequency with other users;
- e. shadowing of some sub-stations by hills;
- f. weak signals from one or more sub-stations; and
- g. congested net.

### **11.44 PROCEDURES**

The following paragraphs detail procedures which should be followed when working in difficult conditions.

### **11.45 WORDS TWICE**

- a. Prowords used are:  
WORDS TWICE  
END WORDS TWICE
- b. This procedure can also be used when communications begin to deteriorate. WORDS TWICE procedure may be initiated by any station on the net for any or all transmissions. call signs and offers are all transmitted twice. Full procedure must be used for transmission using WORDS TWICE procedure.
- c. When working conditions improve the procedure is cancelled by the prowords 'END WORDS TWICE'.

Example:

Curtin Base says: 'VKX777 Curtin 1 THIS IS Curtin Base message OVER'

Curtin 1 says: 'Curtin Base Curtin Base THIS IS THIS IS Curtin 1 Curtin 1 send send WORDS TWICE WORDS TWICE OVER OVER'

Curtin Base says: 'Curtin 1 Curtin 1 THIS IS THIS IS Curtin Base Curtin Base WORDS TWICE WORDS TWICE move move to to grid grid 736 643 736 643 now now OVER OVER'

Curtin 1 says: 'Curtin Base Curtin Base THIS IS THIS IS Curtin 1 Curtin 1 WILCO WILCO OUT OUT'

#### 11.46 RELAY PROCEDURE

a. Prowords used are:

RELAY THROUGH

RELAY TO \_\_\_\_\_

FROM \_\_\_\_\_

THROUGH ME

b. If direct radio communications between any two sub-stations fail, traffic may be relayed through a third station that is in contact with both.

Example:

Curtin 1 calls Curtin 2 but receives no reply: 'VKX777 Curtin 2 THIS IS Curtin 1 move now OVER'

Curtin 1 calls Curtin 2 again: 'VKX777 Curtin 2 THIS IS Curtin 1 move now OVER'

Still no reply so Curtin 1 requests Curtin 3 to relay to Curtin 2: 'VKX777 Curtin 2 THIS IS Curtin 1 nothing heard OUT to you. Curtin 3 THIS IS Curtin 1 RELAY TO Curtin 2 move now OVER'

Curtin 3 has heard the call and will now send it to Curtin 2: 'Curtin 1 THIS IS Curtin 3 ROGER OUT to you. Curtin 2 THIS IS Curtin 3 from Curtin 1 move now OVER'

Curtin 2 has received the message: 'Curtin 2 WILCO OUT'

**Note:** a station acting as a relay station assumes full responsibility for ensuring that the message is passed to the station it was originally intended for.

#### 11.47 FREE AND DIRECTED NETS

a. **Prowords**

Prowords used are:

THIS IS A FREE NET

THIS IS A DIRECTED NET

b. **Free Net**

Under normal conditions a net is free and traffic between sub-stations on the net is uninhibited. The control station determines when the situation requires this freedom to be curtailed.

Example:

Curtin Base says: 'VKX777 All stations THIS IS Curtin Base THIS IS A FREE NET OVER'

Curtin 1 says: 'Curtin 1 WILCO OUT'

Curtin 2 says: 'Curtin 2 WILCO OUT'

Curtin 3 says: 'Curtin 3 WILCO OUT'

c. **Directed Net**

When working conditions are difficult or the flow of traffic is heavy and traffic must be regulated, the control station may order the net to be directed. In a directed net, the control station intercepts each offer and must direct the involved sub-stations on when and how to pass the traffic. The control station is therefore able to regulate all traffic on the net. This regulation and procedure must apply to, and be acknowledged, by all sub-stations on the net.

Example:

Curtin Base says: 'VKX777 ALL stations THIS IS Curtin Base, THIS IS A DIRECTED NET OVER'

Curtin 1 says: 'Curtin 1 WILCO OUT'

Curtin 2 says: 'Curtin 2 WILCO OUT'

Curtin 3 says: 'Curtin 3 WILCO OUT'

d. When a net is directed, an offer by one sub-station to another is answered by the control station in one of the following ways:

Prowords Used:

SEND YOUR MESSAGE OUT

SEND YOUR SITREP OUT

WAIT OUT

THROUGH ME OVER

RELAY THROUGH (sub-station)

Example:

Curtin 2 says: 'VKX777 Curtin 1 THIS IS Curtin 2 message OVER'

Curtin Base says: 'Curtin Base SEND YOUR MESSAGE OUT'

Curtin 1 says: 'Curtin 1 send OVER'

Curtin 2 says: 'Curtin 2 move to GRID 643 718 OVER'

Curtin 1 says: 'Curtin 1 WILCO OUT'

**Note:** On all occasions Curtin Base must give direction to proceed, or not proceed, to the offering Station.

If Curtin Base does not wish the message to proceed it will use the proword WAIT OUT.

## **THE TRANSMISSION OF FORMAL MESSAGES**

### **11.48 OFFERING**

Formal messages are always to be offered and written down by the receiving operator. The offer is to include the following:

- a. The proword **FORMAL MESSAGE** or **LONG FORMAL MESSAGE**.
- b. Any additional information which may aid the receiving operator, such as the requirement for additional copies when the message has to be delivered to more than one addressee by the receiving station.

### **RADIO OPERATOR LOGS**

**11.49** All radio operators should maintain a log while they are on duty. The log fulfils a useful administrative function to:

- a. check whether a message has been transmitted or received;
- b. determine details of other station signal strengths;
- c. log the opening and closing of stations;
- d. brief radio operators coming on duty;
- e. log details of interference for later action; and
- f. log all transmission difficulties.

### **11.50 INFORMATION**

The log should include the following data:

- a. the handover of the radio station from one operator or user to another;
- b. the time of opening and closing of the station;
- c. all procedural transmissions;
- d. causes of delays in transmission or reception of a message;
- e. frequency adjustments and changes;
- f. call signs of other stations that cause interference (so that unsatisfactory frequency allocation may be corrected, if possible);
- g. unusual occurrences, such as procedural violations;
- h. record of informal messages and voice conversations sent to other stations on the net (recorded as completely as possible); and
- i. intrusion and interference details.

### **11.51 FORMAT**

The log entries should be maintained in columns for:

- a. calls from;
- b. calls to;
- c. message text, identity, event;
- d. time (in local time); and
- e. action taken.

## DO'S AND DON'TS

11.52 In summary, some 'do's' and 'don'ts' are as follows:

a. **Do:**

- (1) always speak distinctly at a regular, medium speed, and pitch your voice slightly higher than normal;
- (2) practice and become thoroughly proficient in the use of the **phonetic alphabet**, and the 24 hour clock method of time;
- (3) make use of authorised **prowords**;
- (4) always obey the instructions of the net control station. If you disagree, argue about it after the operation or exercise;
- (5) always think about what you are going to say before you start your transmission and then keep it short and concise;
- (6) be aware of your position in the net order of calling and answering. Remember who answers immediately before you;
- (7) offer to relay messages if you become aware that stations you can hear clearly are having trouble communicating with each other;
- (8) develop the habit of **always** carrying a notebook and pencil with you as this will enable you to write down messages as they are given to you; and
- (9) practice voice procedures regularly in order to retain your skill level.

b. **Don't:**

- (1) shout;
- (2) drop your voice towards the end of sentences;
- (3) develop 'personal quirks' such as 'OVER and OUT' 'negative copy' 'ROGER ROGER', 'do you read' and other non-standard words or phrases;
- (4) use an abbreviation unless you are positive there can be no misunderstanding;
- (5) ever leave or close down your station without permission from the net control station; and
- (6) use profane or obscene language, waste air time, and don't offer unnecessary traffic, particularly in times of emergency.



**Archived**

**AUSTRALIAN EMERGENCY MANUAL  
COMMUNICATIONS**

**SECTION 3**

**EMERGENCY/DISASTER COMMUNICATIONS  
MANAGEMENT**

Section 3 is the final part of the manual and is intended to be read after Sections 1 and 2.

The primary function of Section 3 is to provide assistance to managers and planners in emergency or disaster communications.

## CHAPTER 12

# PLANNING FOR EMERGENCY AND DISASTER COMMUNICATIONS

### GENERAL

**12.1** Control and coordination of emergency operations depend on reliable communications. The communication facilities of emergency service organisations are usually sufficient to meet normal administrative and routine tasks. However, some emergencies and disasters may require additional communication facilities to supplement these systems.

**12.2** Although each emergency or disaster is to some extent unique, much of the operational activity during these incidents is predictable. Appropriate plans can be drafted to match these operational circumstances. Experience has shown that successful emergency and disaster communication systems are those which have been included in plans that are subjected to regular testing and review.

**Note:** Communications planning is an integral part of emergency and disaster plans.

### **12.3 PLANNING**

If possible, the person responsible for communications on a disaster planning committee should be experienced in emergency/disaster communication system concepts. While technical qualifications may be an advantage they are not essential.

### **12.4 AUTHORITY**

The authority for preparing the communications plan must be clearly stated.

### **12.5 ROLES AND RESPONSIBILITIES**

The roles and responsibilities of the various organisations must be clearly defined as a result of the agreement of all parties.

### **12.6 CONTROL AND COORDINATION**

Most emergency/disaster operations require a number of agencies to work together. Each agency will operate its own individual communication system and it is probable that some level of communication between agencies may be necessary. Inter-communication between agencies may be achieved by:

- a. public switched telephone network, unlisted telephones, intercom systems or private line facilities;
- b. courier services;
- c. data, facsimile or telex;
- d. dedicated radio network for coordination purposes; and
- e. collocating elements of the agencies.

## 12.7 INTER-AGENCY COMMUNICATIONS

Agencies may be established in combined operation centres to enhance the management of emergency operations. Whilst each agency involved may have its own communication facilities, placing these facilities together can cause a number of difficulties. Of particular concern is acoustic noise which can be minimised by the use of sound absorbent material and headsets. Another concern is the collocation of radio communications equipment, which may generate interference in the radio networks.

- 12.8 Suggestions that placement of operational elements on a common radio channel may enhance the management of the emergency operation should be resisted. While this may be a solution with a small scale operation involving few organisations, a large scale operation requires separate frequencies and networks; network congestion may occur if this principle is not adhered to.

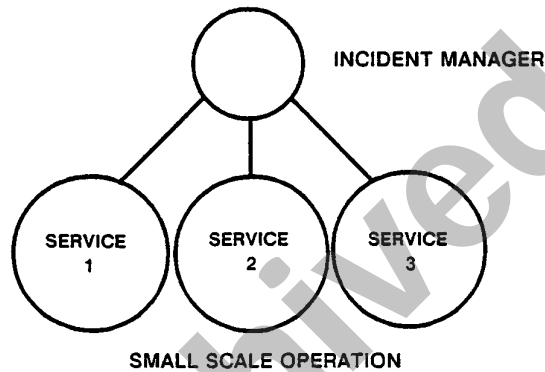

Figure 12:1—Small Scale Operation

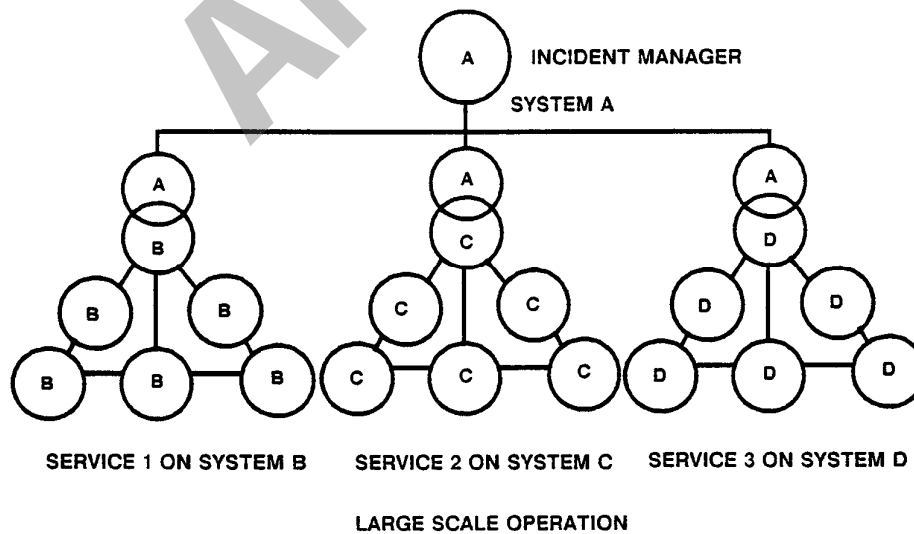

Figure 12:2—Large Scale Operation

- 12.9 To aid inter-agency communication at management level, dedicated communication networks should be established. Whilst there may be advantages in operating on a common channel it is usually more appropriate

for each radio network to handle messages for its own organisation. The use of multiple networks will ensure that the majority of messages proceed should a single system fail.

#### **12.10 RESOURCES**

The plan must list contact names, numbers and appropriate resources. This list should include information on how these resources can be obtained at short notice and it must be updated regularly. A map displaying the distribution of communication resources should be included.

#### **12.11 COMMUNICATIONS FOR SPECIFIC OPERATIONAL SITUATIONS**

Detailed plans for specific operational situations should be considered, especially where communication difficulties are anticipated. Special communication facilities may be required to meet these situations.

#### **12.12 NETWORK DIAGRAMS**

Network diagrams provide a visual display of communication structures and traffic flow and are useful in illustrating the networks available.

#### **12.13 REDUNDANCY**

Whenever possible, alternative or backup communication facilities should be identified and any necessary compromises noted.

#### **12.14 PLANNING DETAIL**

Plans relating to events at a local community level can be quite detailed. However, plans intended for regional, state or national events do not need the same detail. All plans should be kept as brief as clarity will permit.

**Archived**

## CHAPTER 13

### THE COMMUNICATIONS CENTRE

#### GENERAL

**13.1** The Communications Centre (COMCEN) is the focal point for communications at operations centres. The function of a COMCEN is to ensure that communications traffic is handled accurately and efficiently making the most economical use of the communication systems available.

#### **13.2 COMMUNICATIONS CENTRE RESPONSIBILITY**

The COMCEN is responsible for messages traffic from the time they are accepted until they reach their destination. All traffic should be dispatched with minimum delay between receipt and transmission of out-going messages.

#### **13.3 COMCEN ORGANISATION**

The COMCEN is organised and staffed to enable the following functions to be achieved:

- a. Accept messages and reports and send them to their destinations.
- b. Receive, route or deliver messages to the addressees listed.
- c. Maintain a record of messages, reports and dispatches actioned by the COMCEN.

#### **13.4 REGISTRATION OF COMCEN MESSAGES**

Message handling should not be delayed by complicated systems of registration. Adequate records should be used to enable tracing of messages which may be delayed or do not reach their destination. Most computer message and facsimile systems store the original message and complete log details for 'header information', ie message number, date/time group, subject, from and message status. An example of a manual message registration form is shown below:

| Message Registration Form |      |      |      |         |        |        |          |
|---------------------------|------|------|------|---------|--------|--------|----------|
| Message Number            | Date | Time | From | Subject | Action | Status | Initials |
|                           |      |      |      |         |        |        |          |

Figure 13:1—A Manual Message Registration Form

### 13.5 MESSAGE HANDLING PRINCIPLES

The method of dealing with messages through a COMCEN is based on the following:

- a. every message accepted by a COMCEN will be delivered to its destination. If not, the message originator must be advised.

While speed in the delivery of messages is essential, accuracy is paramount.

- b. COMCEN staff must never alter any portion of the text of a message, without the approval of the originator.

### 13.6 COMMUNICATIONS CENTRE LAYOUT

The layout of a COMCEN will vary according to the size and operational requirements of the organisation. It may be permanently set-up or temporarily established for a particular task. Although the facilities and concepts may vary, the basic functions should remain the same.



Figure 13:2—Typical Communications Centre

### 13.7 COMCEN STAFF

The procedure and duties to be performed in a COMCEN remain the same regardless of the size of the organisation. The number of personnel employed will vary according to the size of the operation.

### 13.8 COMCEN SUPERVISOR

The COMCEN supervisor is responsible for the efficient management of staff and facilities to enable the COMCEN to function effectively. He/she must have a thorough knowledge of the COMCEN and its procedures including a working knowledge of the various communication systems available.

### 13.9 STAFF WELFARE

Facilities should be designed to minimise staff fatigue and optimise comfort. Adequate provision must be made to enable operators to be rostered through various job tasks to reduce stress. Staff who have been exposed to traumatic messages should be included in CRITICAL INCIDENT STRESS DEBRIEFING (CISD) programs.



### **13.10 SILENT TELEPHONES**

The COMCEN should be equipped with silent or unlisted telephone numbers to enable calls to be made in the event of congestion or PABX (if used) or other failure. These telephones should be connected to different telephone exchanges via alternative cable routes if possible. If in a cellular phone area, mobile phones can be used as backups to the fixed wire system.

### **13.11 NOISE AND ACCESS**

Noisy equipment such as radios, computer printers and telex machines should be acoustically shielded and isolated from the COMCEN. Access to the COMCEN should be strictly controlled to avoid disruptions.

### **13.12 EMERGENCY OPERATIONS CENTRE SITING**

COMCEN supervisory and technical personnel should be consulted **before** the establishment of any permanent or temporary operations centre. If a site is selected without consultation with communications personnel, the centre may be deficient of all or part of the necessary communication systems.

### **13.13 BASIC MESSAGE FORMS**

A message of vital importance or one containing essential information should always be written or typed. The written message will ensure that the following information is available:

- a. A record of where the message originated and its addressee.
- b. A record of the text.
- c. A record of the date and time of receipt or dispatch of the message.

A formatted message enables telephone or radio operators to send or receive messages clearly and concisely, minimising time on congested networks.

- 13.14** Some organisations prefer computer generated forms. However, emergency service organisations should retain the ability to revert to manual operation in the event of computer failure.



## CHAPTER 14

# ORGANISATION OF COMMUNICATIONS IN THE FIELD

### GENERAL

**14.1** Field communications are communications in support of field operations which can be of any size, from a chemical spill to an earthquake affecting a major city. All of these incidents/events require a well organised communications system.

### **14.2 THE IMPORTANCE OF A COMMUNICATIONS PLAN**

All operations require communications for command, control and coordination purposes. Too often an operation starts without a communications plan. Indeed, the priorities often seem to be deployment of personnel and material into the operation and only when it is discovered that command, control and coordination are missing are the communications specialists called in to provide a communications system. By this time, it may be too late.

**14.3** Experience has shown that if a communications plan is implemented in the earliest stages of an operation, the operation will run much more smoothly from the outset. If the operation commences badly due to lack of communications, it may take days or weeks to recover.

**14.4** The elements of reconnaissance, installation, operation, system close-down and post-operational briefings contribute to the conduct of a successful operation.

### ORGANISATIONAL ELEMENTS

### **14.5 RECONNAISSANCE OF THE FIELD OPERATIONS CENTRE ('TIME SPENT IN RECONNAISSANCE IS NEVER WASTED')**

No matter what the size of the operation, a reconnaissance must be made to select a suitable site for the future field operations centre. Sometimes the reconnaissance may only take several minutes due to the urgency of the situation. At other times, several hours or days may be available for this task. The importance of the reconnaissance cannot be over emphasised as it is critical in determining access to power; telephones, antenna space and suitability for VHF/UHF/HF radios during the operation.

**14.6** The reconnaissance party must include the communications manager so that specialist advice can be given to the operational commander on the appropriateness or otherwise of the proposed site. However, the communications site should not be developed in isolation from the operational need. On occasions there will be no option other than to occupy a particular site which is less than ideal. If this occurs, the communications manager must seek to optimise the site for communications. For example, in the placement of antennas, the availability of power, access to telephones, the communications manager may require additional resources to cater for the site's deficiencies.

## **14.7 SITE SURVEY**

When surveying the site for likely operations always consider:

- a. access to the site;
- b. site security;
- c. power availability;
- d. proximity to the operational threat;
- e. antenna space;
- f. freedom from radio interference;
- g. proximity to the operational centre; and
- h. compatibility with the operational requirements.

## **14.8 EQUIPMENT INSTALLATION**

After the selection of the site, be sure to:

- a. ensure communications resources are first into the area;
- b. establish and maintain rear link communications;
- c. establish and maintain area of operations communications links;
- d. minimise acoustic and electrical noise from generators and other sources;
- e. compile and promulgate shift rosters;
- f. compile and distribute telephone directories;
- g. compile and distribute radio schedules to radio operators;
- h. locate and minimise radio interference problems;
- i. establish battery charging and minor workshop facilities;
- j. establish communications status display boards in the Communications Centre and the Operations Centre; and
- k. limit access to the Communications Centre.

## **14.9 OPERATION**

During an operation, always be sure to:

- a. maintain and improve if necessary all communications links;
- b. produce radio coverage maps;
- c. maintain communications status display boards;
- d. identify and label all defective equipment and ensure it is returned for repair;
- e. establish and maintain liaison with Operations Centre personnel;
- f. consider the provision of operators and equipment for liaison duties;
- g. establish an area Communications Manager if possible;
- h. consider the provision of reserve communications resources;

- i. establish and regularly test additional alternative communications systems that may be required in the event of failure or operation escalation;
- j. consider communications requirements should the Operations Centre need to move;
- k. establish and maintain equipment loan procedures;
- l. maintain and manage all communications equipment resources;
- m. consider personnel management including the requirements of occupational health and safety; and
- n. brief communications staff, regularly.

#### **14.10 CLOSING DOWN**

So that communications are available to the end of the operation, communications resources should be the last items to be redeployed. On closing down, staff should:

- a. recover all radios and stores on loan to individuals and organisations;
- b. dismantle and remove all radio installations such as repeaters, masts; and
- c. identify and label all faulty equipment for repair.

#### **14.11 POST-OPERATION**

Following redeployment, always:

- a. repair and maintain radio equipment;
- b. conduct debriefing and review lessons learnt;
- c. amend training if necessary;
- d. procure additional equipment if required;
- e. plan exercises to overcome operational deficiencies; and
- f. amend SOPs where required.

### **FIELD COMMUNICATION TECHNIQUES**

**14.12** The correct use of VHF, UHF and HF communications in the field is often a confusing issue. Many radio operators are reluctant to leave the security of the field Talk-Through-Repeater (TTR) for simplex operation as simplex is perceived to be less capable than TTR operations. Inevitably, an absence of communications will force the communications manager to try simplex and if the following explanations are born in mind then successful communications can result.

- 14.13** Figure 14:1 represents two field teams communicating in simplex mode (ie direct set-to-set). The likely disadvantage of this configuration is that range could be limited due to the loss of 'line of sight' communications. This is more likely to occur in hilly country.

The Figure shows two field teams communicating in SIMPLEX mode (ie directly set to set). The likely disadvantage is that range will be quite limited due to the loss of line of sight communications. This is particularly so in hilly country.

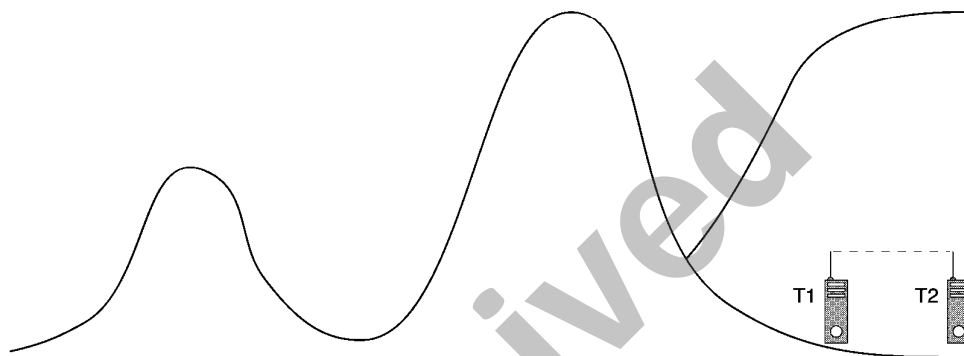

Figure 14:1—Simplex Mode of Operation

- 14.14** Figure 14:2 shows how a base station can be located on high ground to improve line of sight communication by having the base relay messages between stations. This can also be achieved by using a REPEATER base station.

The Figure shows how a base station can be located on high ground to improve line of sight communication and increase the range of communication by having the base relay messages between stations. This can also be achieved by using a REPEATER base station.

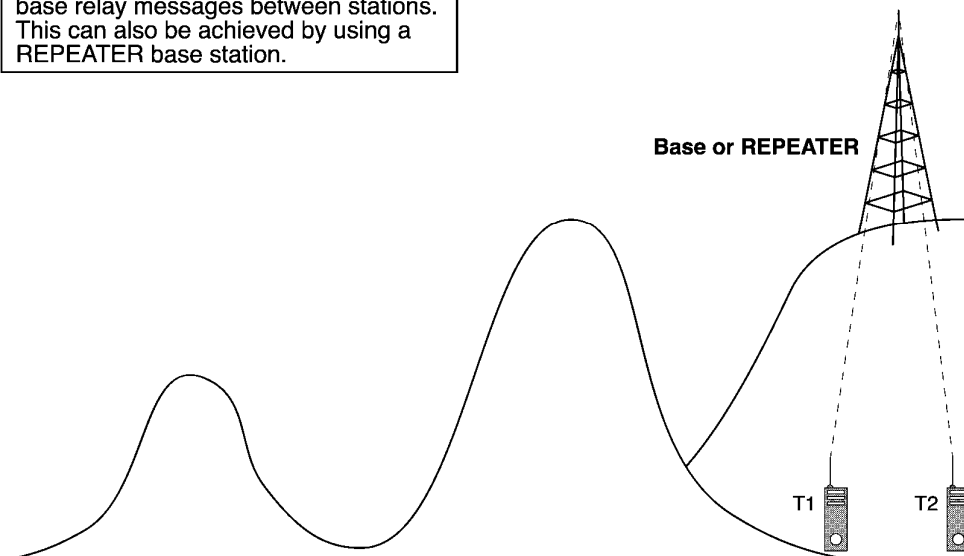

Figure 14:2—Repeater Mode of Operation

- 14.15** Figure 14:3 demonstrates how communication is disrupted by hills or mountains. It can be seen that in this case the field units are operating in an area that is shaded from the repeater. These units are not able to communicate via the repeater.

The Figure demonstrates how communication is disrupted by hills or mountains. It can be seen that in this case the field units are operating in an area that is shaded from the repeater. These units are not able to communicate via the repeater.

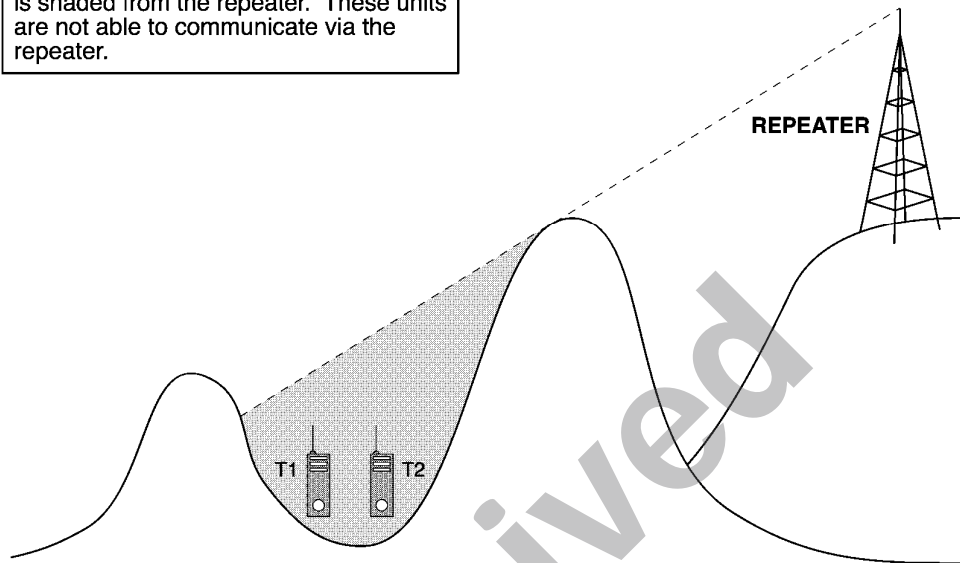

Figure 14:3—Repeater Mode of Operation

- 14.16** Figure 14:4 shows that even though repeater communications are not possible, field units may be able to communicate with each other via a simplex channel.

The Figure shows that even though repeater communications are not possible, field units may be able to communicate with each other via a simplex channel.

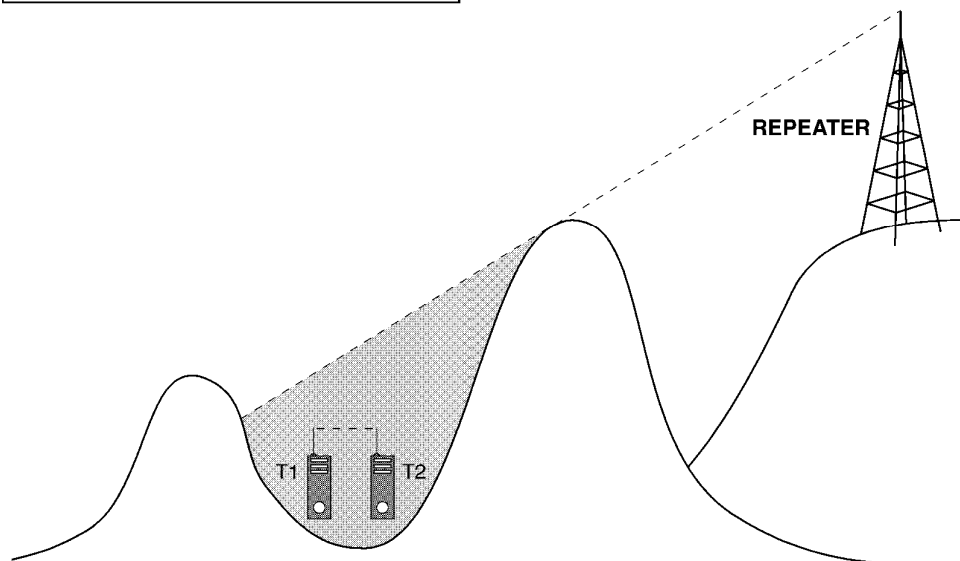

Figure 14:4—Simplex Operation in Field

- 14.17** Figure 14:5 represents a number of teams in the field with a variety of means of communication. Some are able to communicate via the repeater while some are able to communicate in simplex mode. However, there is no single medium that is common to all units.

The Figure represents a number of teams in the field with a variety of means of communication. Some are able to communicate via the repeater, some are able to communicate via simplex, but there is no single medium that is common to all units.

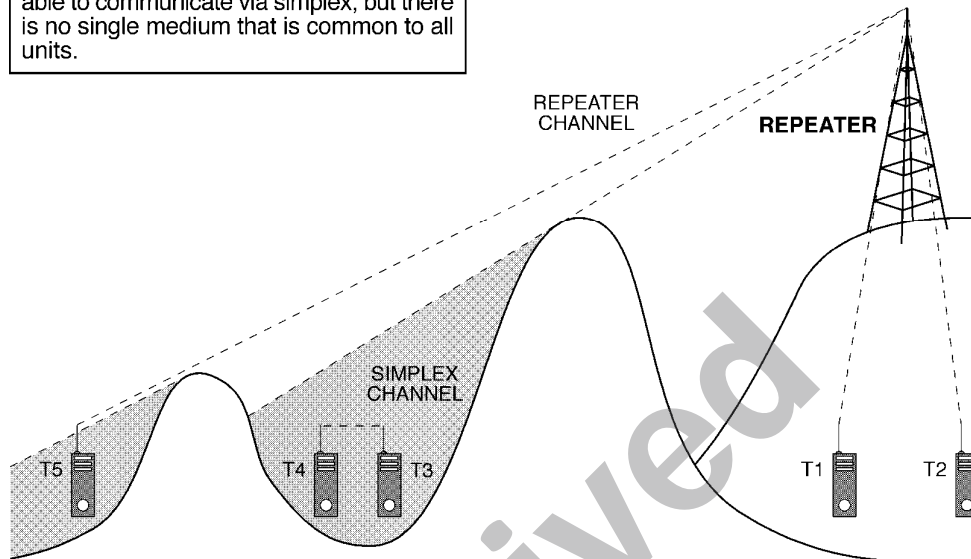

Figure 14:5—Combined Repeater and Simplex Operation

- 14.18** Figure 14:6 shows how a strategically placed mobile can be used to relay messages between field units having difficulty with field intercommunications. The mobile must use a pre-arranged time schedule to communicate with simplex and repeater (or base) channels at different times; without this technique, calls may be missed.

The Figure shows how a strategically placed mobile unit can be used to relay messages between field units having difficulty with intercommunication. It should be noted that the mobile must use a pre-arranged time sked to communicate with simplex and repeater (or base) channels at different times. Without this technique, calls may be missed.

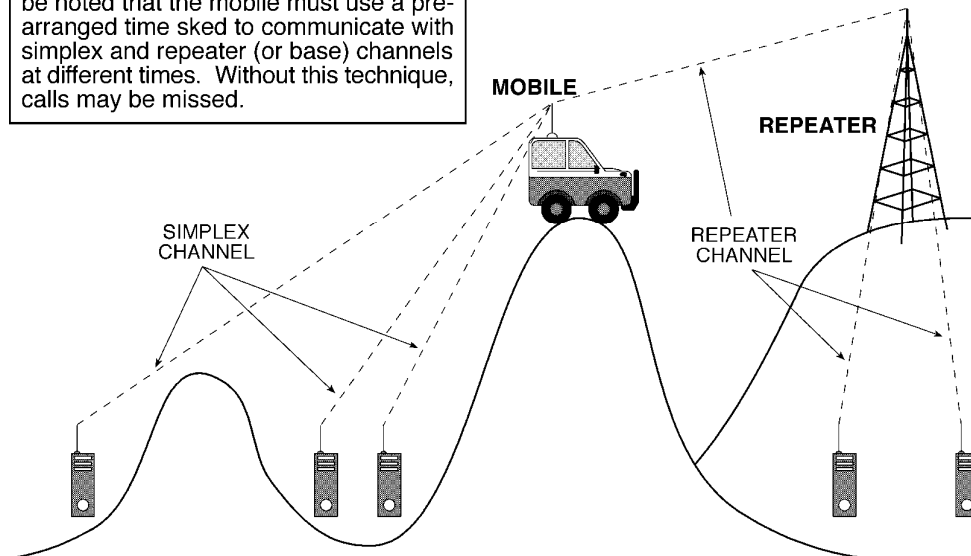

Figure 14:6—Repeater Operation—Simplex and Mobile Units



- 14.19** Figure 14:7 indicates a better arrangement. All field units are operating on the simplex channel with the mobile acting as a network control (and relay) station. Communication back to the headquarters is achieved (via the repeater or base) with timed schedules. It is also possible to use a scanning radio to monitor both networks. However, calls can be missed if both networks operate at the one time.

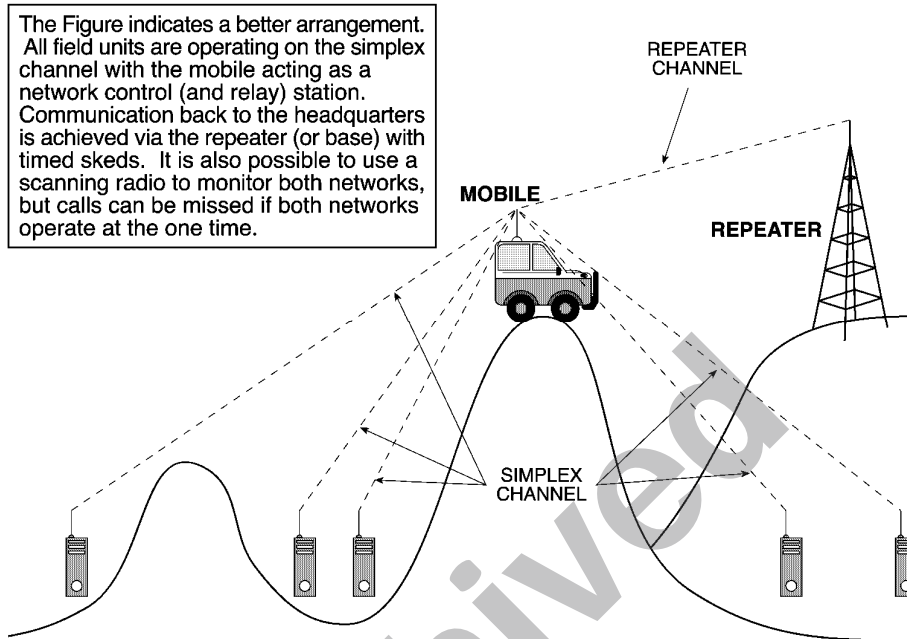

Figure 14:7—Repeater Operation—Mobile and Simplex Units

- 14.20** Figure 14:8 shows how two transceivers can be used to monitor both the simplex and repeater channels. This overcomes the deficiencies of timed schedules and scanning but requires the use of an additional radio. Although two portable radios are shown in this scenario, mobiles, transportable bases or a mix of all three types may be possible.

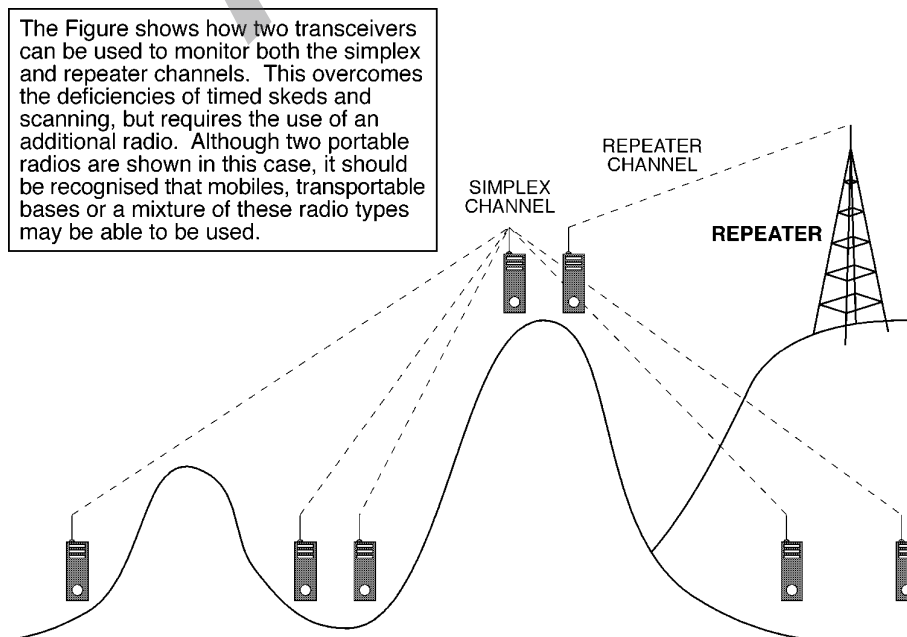

Figure 14:8—Repeater and Simplex operation

- 14.21** Figure 14:9 demonstrates a further mix of networks. The field units are able to communicate via a simplex network (VHF, UHF or 27Mhz) while the rear link to HQ is achieved via HF radio. The HF link can operate in ground wave or sky wave modes.

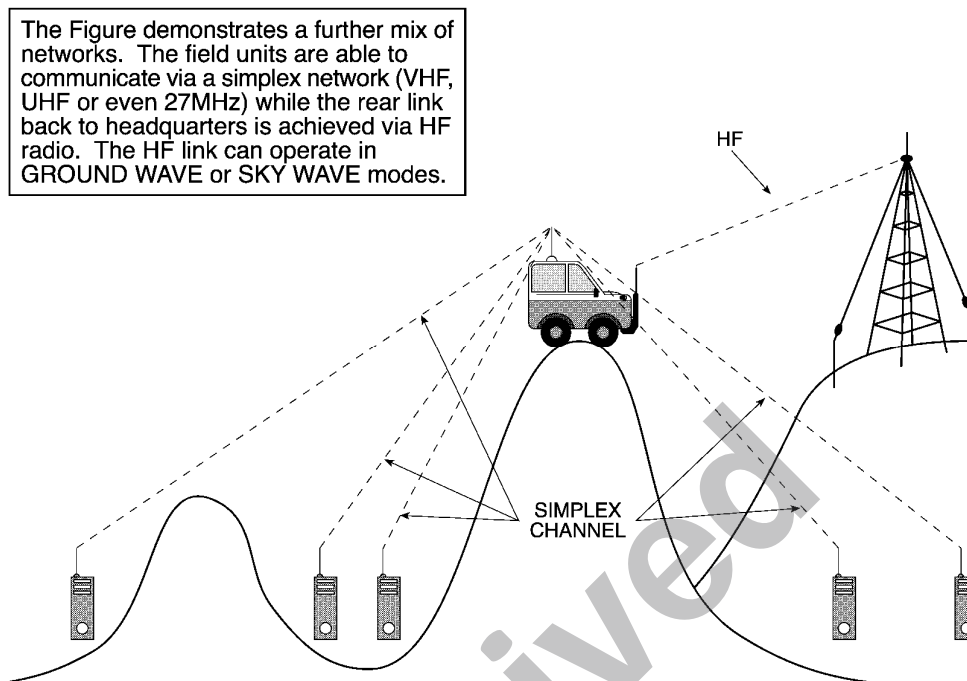

Figure 14:9—Repeater and Simplex Operation—HF Rear Link

- 14.22** Figure 14:10 indicates how two or more field networks operating on different channels (eg SES and Police) can be coordinated from a properly sited field Emergency Operations Centre. Another channel is used for rear link communications to the major headquarters. Messages that need to be sent by telephone can often be relayed to the major headquarters for action.

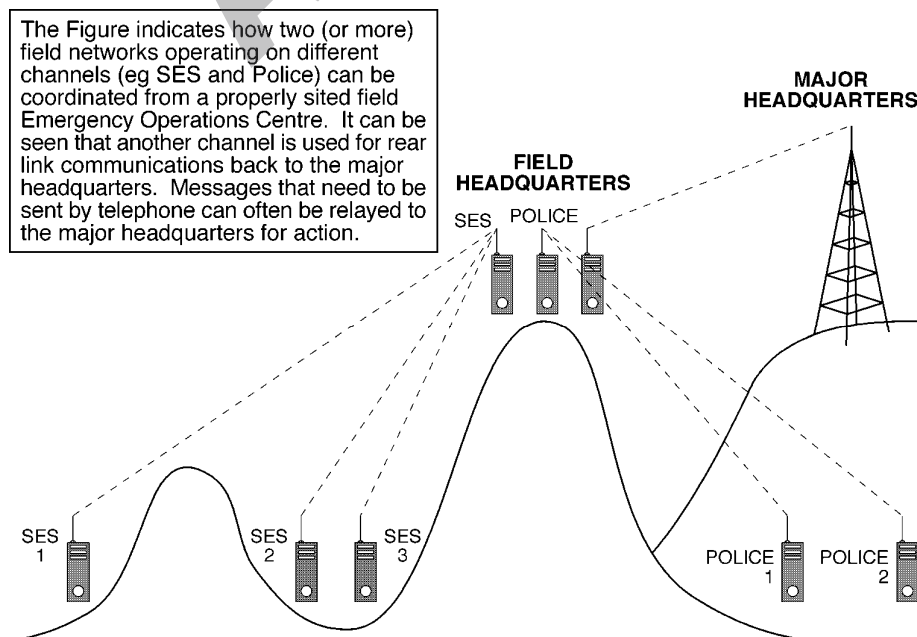

Figure 14:10—Field Networks on Different Channels

## **FIELD COMMUNICATIONS EQUIPMENT MANAGEMENT**

**14.23** The correct management of batteries, stores and allocation of priorities in the field will help to ensure the effectiveness of command and control during operations. Irrespective of the quality of planning and the communications available, the operation could fail if sound communication management techniques are not adopted at the outset.

### **14.24 BATTERY MANAGEMENT**

Battery management assumes high importance during operations. A qualified person must be appointed before the start of the operation to manage the batteries; their primary task must be battery management. Battery issue to operators, receipt and charging should be carried out at a central location, located in the vicinity of the operations centre.

**14.25** Replacement of batteries should occur at the end of the day or the completion of a shift, so that the opportunity can be taken to recharge the batteries. This opportunity also allows the communications manager to re-allocate radios to other operators if operational priorities change. Adequate stocks of all battery types in use must be available for the operation.

**14.26** Conditioning of NiCad batteries is a process of charge/discharge cycles, which help maintain batteries near peak capacity. Conditioning should be carried out on batteries when new and before they are placed into service. Manufacturers provide details on battery conditioning. Full conditioning is a time consuming process and should be carried out in a workshop or controlled environment.

**Archived**

## CHAPTER 15

### MISCELLANEOUS COMMUNICATIONS ISSUES

#### COMMUNICATION SURVEYS

**15.1** On completion of the installation of a fixed radio communications system, a radio survey should be conducted to provide operational managers with detailed knowledge of the area coverage available. Although the task is labour-intensive, the results obtained will ensure communications are more effective by identifying areas where difficulties could be expected.

#### **15.2 SURVEY TECHNIQUE**

The survey technique is simple. Field operators are given a map or an overlay and are sent into a specific area. At pre-determined distances the field operator calls the base and receives a signal report. If signals are readable, a green dot is placed on the map at the operator's position. If signals are unreadable, a red dot is placed on the map.

#### **15.3 PERFORMANCE MAPS**

The process is repeated until the area specified has been adequately covered. When the operators return to base, information from the individual maps is transcribed to a master map. Over a period of time, a signal performance profile of the area is built up, clearly identifying the areas where good communications are possible as well as identifying trouble spots.

#### **15.4 EQUIPMENT PERFORMANCE VARIATIONS**

Caution must be exercised to ensure that equipment being used is in good working order. When system upgrades take place the survey needs to be repeated.

**15.5** Variations are also possible. One map may show hand-held performance, another manpack performance, while yet another may show mobile transceiver results. Different signal levels may be shown by the use of additional coloured dots.

#### **15.6 SETTING PRIORITIES**

The task is obviously labour-intensive and priorities should be set to undertake the task so that some useful data is available early in the process. For example, areas where activations occur frequently should be tested first. Suspected poor performance areas may be surveyed next and so on. Surveys can be done in conjunction with other field activities.

#### **15.7 BENEFIT**

Although considerable effort is required to complete the survey, the results gained will help operational communications run more smoothly by identifying communication difficulties ahead of time.

## **PUBLIC INFORMATION**

- 15.8** Disaster-affected communities have a need to receive information relevant to their circumstances. In the absence of such information, rumors may abound and consequent difficulties may be experienced.

### **15.9 DISSEMINATION**

If the normal media outlets, ie TV, radio and newspapers, are either not available or do not provide sufficient relevant detail, other methods will be needed by the affected communities. Printed media in the form of newsletters or newspapers can be used to good effect in providing public information to disaster-affected communities. As a general rule, media liaison officers are appointed to ensure that information is effectively disseminated to the public.

## **LICENSING OF RADIO TRANSCEIVERS**

- 15.10** The radio spectrum is a limited resource, with high commercial value to any community or country. The spectrum is organised into an international management system which allows responsible use by radio operators. Australia is a member of the International Telecommunications Union (ITU) and abides by its rulings.

### **15.11 MANAGEMENT**

The licensing arrangements within Australia are managed and controlled by the Australian Communications Authority (ACA) and the resource is provided on a 'user pays' principle. The provision and use of the radio spectrum is charged at various rates dependent upon services provided.

- 15.12** Radio transceivers must be operated in accordance with the relevant regulations and licensing requirements. **Severe penalties apply to illegal users of the radio spectrum.**