

Australian Disaster Resilience Handbook Collection

This manual is no longer current. It has been archived. This manual will not be reviewed and should be used for historical reference only.

For further information please refer to AFAC Doctrine



Australian Institute for
Disaster Resilience

AUSTRALIAN EMERGENCY
MANUAL SERIES

SKILLS FOR EMERGENCY SERVICES PERSONNEL

**FLOOD RESCUE BOAT
OPERATION**

Third Edition

MANUAL NUMBER 39

COPYRIGHT

Permission to use the document and related graphics is granted provided that (1) the below copyright notice appears in all copies and that both the copyright notice and this permission notice appear, and (2) use of document and related graphics is for educational, informational and non-commercial or personal use only.

In all cases the Commonwealth of Australia must be acknowledged as the source when reproducing or quoting any part of this publication. Examples and quotations from other sources have been attributed to the original publication whenever possible and are believed to fall within fair use provisions, but these portions retain their copyright protection and must not be used without attribution.

Enquiries related to copyright should be addressed to:

The Director General

Emergency Management Australia

PO Box 1020

Dickson ACT 2602

Or telephone +61 (0) 2 6256 4600 or fax +61 (0) 2 6256 4653 or email ema@ema.gov.au

Any rights not expressly granted herein are reserved.

DISCLAIMER

This publication is presented by Emergency Management Australia for the purpose of disseminating emergency management information free of charge to individuals who provide professional training and supervision to members of professional organisations in the field of emergency management. Professional organisations include, but are not limited to, professional fire fighters, trained emergency services volunteers, and members of State/Territory police and rescue organisations whose members have training and basic competencies in emergency management services.

The information in this publication is not intended to be used by the general public or untrained persons, and is not a substitute for professional advice and/or training. Untrained persons should not use this publication unless a trained and qualified emergency management professional supervises them and/or their training in the subjects listed in the publication.

Emergency Management Australia, in consultation with emergency management professionals and subject matter experts, exercises care in the compilation and drafting of this publication, however, the document and related graphics could include technical inaccuracies or typographical errors and the information provided may not be appropriate to all situations. In no event shall the Commonwealth of Australia (acting through Emergency Management Australia) be liable for any damages whatsoever, whether in an action of contract, negligence or other tortious action, arising out of or in connection with the use of or reliance on any of the information presented in this publication.

Emergency Management Australia periodically updates the information in this publication. Before using this publication, please check with the training officer in the State Emergency Service organisation in your State/Territory to ensure that this edition is the most recent and updated version of the publication.

INTELLECTUAL PROPERTY STATEMENT

In contributing to the development of this manual, it is acknowledged that no ongoing rights to the information are retained by individual contributors. The information contained within this manual is not owned by individuals or State/Territory organisations but is held in trust by the Commonwealth on behalf of the Australian community. The information contained within this manual is current as at January 2009.

© Commonwealth of Australia 2009

First published 1991

Second edition 1999

Third edition 2009

ISBN 978-1-921152-13-9

The Australian Emergency Manual Series

The first publication in the original Australian Emergency Manual (AEM) Series of mainly skills reference manuals was produced in 1989. In August 1996, on advice from the National Emergency Management Principles and Practice Advisory Group, Emergency Management Australia (EMA) agreed to expand the AEM Series to include a more comprehensive range of emergency management principles and practice reference publications.

The AEM Series has been developed to assist in the management and delivery of support services in a disaster context. It comprises principles, strategies and actions compiled by practitioners with management and service delivery experience in a range of disaster events.

The series has been developed by a national consultative committee representing a range of State and Territory agencies involved in the delivery of support services and is sponsored by EMA.

Details of the AEM Series are available on the EMA website, under publications, at www.ema.gov.au/. These manuals are also available free of charge on CD. Please send requests to ema@ema.gov.au.

Australian Emergency Manual Series structure and content

Principles and reference manuals

Manual 2	Australian Emergency Management Arrangements
Manual 3	Australian Emergency Management Glossary
Manual 4	Australian Emergency Management Terms Thesaurus
Manual 18	Community and Personal Support Services
Manual 29	Community Development in Recovery from Disaster
Manual 15	Community Emergency Planning
Manual 27	Disaster Loss Assessment Guidelines
Manual 9	Disaster Medicine
Manual 28	Economic and Financial Aspects of Disaster Recovery
Manual 8	Emergency Catering
Manual 1	Emergency Management Concepts and Principles
Manual 23	Emergency Management Planning for Floods Affected by Dams
Manual 5	Emergency Risk Management— <i>Applications Guide</i>
Manual 43	Emergency Planning
Manual 11	Evacuation Planning
Manual 20	Flood Preparedness
Manual 22	Flood Response
Manual 21	Flood Warning
Manual 25	Guidelines for Psychological Services: Emergency Managers Guide
Manual 26	Guidelines for Psychological Services: Mental Health Practitioners Guide
Manual 44	Guidelines for Emergency Management in Culturally and Linguistically Diverse Communities
Manual 13	Health Aspects of Chemical, Biological and Radiological Hazards
Manual 6	Implementing Emergency Risk Management— <i>A facilitators guide to working with committees and communities</i>
Manual 42	Managing Exercises
Manual 19	Managing the Floodplain
Manual 17	Multi-Agency Incident Management
Manual 31	Operations Centre Management
Manual 7	Planning Safer Communities— <i>Land Use Planning for Natural Hazards</i>
Manual 14	Post Disaster Survey and Assessment
Manual 10	Recovery
Manual 24	Reducing the Community Impact of Landslides
Manual 12	Safe and Healthy Mass Gatherings
Manual 41	Small Group Training Management
Manual 16	Urban Search and Rescue— <i>Capability Guidelines for Structural Collapse</i>

Skills for emergency services personnel manuals

Manual 38	Communications
Manual 39	Flood Rescue Boat Operation
Manual 37	Four Wheel Drive Vehicle Operation
Manual 35	General and Disaster Rescue
Manual 33	Land Search Operations (<i>this manual is no longer available through EMA—refer to website http://natsar.amsa.gov.au/Manuals/index.asp.</i>)
Manual 32	Leadership
Manual 36	Map Reading and Navigation
Manual 34	Road Accident Rescue
Manual 30	Storm and Water Damage Operations
Manual 40	Vertical Rescue

Archived

Foreword

On 7 June 2007, the NSW east coast experienced a severe storm that caused widespread flooding and damage to the Central Coast, Hunter Valley and Sydney metropolitan areas. The region was struck by two more severe weather events in the following two weeks causing further flooding and total damage costs of \$1.4 billion. The flood waters resulted in more than 6000 residents being evacuated, with many evacuations requiring the use of helicopters or SES flood rescue boats. SES flood rescue boat crews also undertook resupply operations for the flood-isolated areas.

In January and February 2008, flooding rivers in Queensland's Mackay and Emerald regions caused more than \$400 million in damage with significant areas of the State under water at one time. This event also required the use of flood rescue boats for evacuation and resupply operations.

This third edition of the manual *Flood Rescue Boat Operation* in the *Skills for Emergency Services Personnel* section of the *Australian Emergency Manual (AEM)* series provides a basic reference for flood rescue boat operations. These operations are inherently hazardous and should only be undertaken by trained personnel. This manual is intended for use in the planning, training and operations of emergency service personnel and organisations.

The use of trade names in this manual is not intended to be restrictive, preferential or promotional; rather, trade names are used where descriptive clarity is required. Where trade names are utilised it should be understood that these products are neither officially endorsed nor recommended by Emergency Management Australia or individual emergency service organisations.

I would like to thank the State Emergency Service National Education and Training Committee (SES NETC) for coordinating this review and for ensuring current national best practice in flood rescue boat operation skills. As situations change and improved techniques are developed, the *Flood Rescue Boat Operation* manual will be updated and amended under the auspices of the SES NETC. Suggestions for changes should be forwarded to EMA at the address shown below.

Director General
Emergency Management Australia

Emergency Management Australia, Attorney-General's Department, National Circuit BARTON ACT 2600

End of chapter. This page left intentionally blank.

Archived

Contents

Chapter 1

Introduction to Flood Rescue Boat Operations

1.1	Flood rescue boat functions	1
1.2	Crew requirements	2
1.2.1	Knowledge	2
1.2.2	Licensing and boating regulations	2
1.2.3	Knowledge of boat and motor	2
1.2.4	Working safely, responsibly and professionally	2
1.2.5	Swimming ability	2
1.3	Personal protection	3
1.3.1	Personal protective equipment	3
1.3.2	Heat and sun	4
1.3.3	Cold	4
1.3.4	Fatigue	5
1.3.5	Contaminated water	5
1.3.6	Insects	5
1.3.7	Critical incidents	5
1.4	Crew positions	5
1.4.1	Minimum number of crew members	5
1.4.2	Responsibilities of the crew	6
1.4.3	Accident and near-miss reports	6
1.4.4	Final decision	7

CHAPTER 2

Equipment and Maintenance

2.1	The boat	9
2.1.1	Parts of a boat	10
2.2	The hull	10
2.2.1	Hull types	10
2.2.2	Hull maintenance	12
2.2.3	New fittings	13
2.3	The motor	13
2.3.1	Parts of an outboard motor	13
2.3.2	The ignition system	14
2.3.3	The cooling system	14
2.3.4	The fuel system	14
2.3.5	Lubricating oil	15
2.3.6	Guard against fire	16
2.3.7	The gearbox	16
2.3.8	Propellers	16
2.3.9	Understanding propeller pitch	16
2.3.10	Propeller types	17
2.4	The controls	18
2.4.1	Boats with forward controls	18
2.4.2	Motors with tiller controls	19
2.4.3	Kill switch lanyard	19
2.4.4	Motor trim and tilt system	19

2.4.5	Motor mounting.....	20
2.4.6	Motor maintenance	20
2.5	The trailer.....	21
2.5.1	Types of trailers	21
2.5.2	Trailer maintenance	23
2.5.3	Trailer adjustment	23
2.6	Periodic maintenance.....	23
2.7	Safety equipment	29
2.7.1	Compulsory safety equipment	29
2.7.2	Recommended safety equipment.....	30
2.7.3	Equipment for special jobs.....	31

CHAPTER 3

Safety in FRB Operations

3.1	Risk management process.....	33
3.2	Personnel	33
3.3	Hazard identification.....	33
3.4	Common hazards	34
3.4.1	Weather conditions	34
3.4.2	Working at night.....	35
3.5	Public utilities.....	35
3.5.1	Electricity	35
3.5.2	Safe working clearance	35
3.5.3	Powerlines	36
3.5.4	Sewerage.....	38
3.6	Trees and branches	39
3.7	Debris.....	39
3.7.1	Chemicals	39
3.8	Fauna	39
3.9	Contamination and disease.....	39
3.10	Equipment and vehicles	39
3.11	Main FRB safety considerations.....	40
3.11.1	The weather	40
3.11.2	Safety before and during an operation	40
3.11.3	The stop and take 5 rule	41
3.12	Controlling risks.....	42
3.13	Summary of risk management	43
3.14	Safety responsibilities.....	43

CHAPTER 4

Plan and Prepare for an Operation

4.1	The AOLR process	45
4.2	Assess.....	45
4.2.1	Make the decision.....	46
4.2.2	Local knowledge	46
4.3	Organise.....	49
4.3.1	Report the departure.....	49
4.3.2	SMEAC briefing	49
4.4	Lead	50
4.5	Review.....	51
4.5.1	The www.debrief	51

CHAPTER 5

Tow, Launch and Recover

5.1	Pre-departure checks	53
5.2	Towing	54
5.2.1	Reversing	55
5.2.2	Reversing with a guide	55
5.2.3	Reversing using the mirrors	56
5.3	Launch and recovery from a boat ramp	56
5.3.1	Launching from a boat ramp	57
5.3.2	Driving the FRB from the trailer	60
5.3.3	Winch-on recovery	60
5.3.4	Drive-on recovery	63
5.4	Launch and recovery from an improvised site	65
5.4.1	Safety during an improvised launch	65
5.4.2	Improvised launch without a vehicle	66
5.5	Post-recovery checks	68
5.6	Launch site hazards	69
5.7	Restoring the FRB	69

CHAPTER 6

Driving and Handling the FRB

6.1	Boarding small vessels	71
6.2	Start-up procedure	72
6.2.1	Emergency starting	72
6.3	Lookout	72
6.4	Driving the boat	72
6.4.1	Accelerating	72
6.4.2	Safe speed	73
6.4.3	Reversing	73
6.4.4	Stopping	73
6.4.5	Trimming the motor	74
6.5	Steering the boat	76
6.5.1	Steering with a tiller	77
6.5.2	Steering with forward/side controls	77
6.5.3	Turning	78
6.5.4	Turning around using the three-point method	79
6.5.5	Turning around using twin outboards	79
6.5.6	Pivot turn using twin outboards	80
6.6	Beaching	81
6.6.1	Tying the boat on a bank	81
6.7	Leaving a fixed structure	82
6.7.1	Using a spring line (forward)	82
6.7.2	Using a spring line (reverse)	82
6.8	Coming alongside a fixed structure	83
6.8.1	Coming in bow on	84
6.9	Ropework	85
6.9.1	Knots	85
6.9.2	Belaying	87
6.9.3	Belaying to a cleat or bollard	87
6.9.4	Rope stowage	87
6.10	Anchoring	87
6.10.1	Dropping anchor	87

6.10.2	Recovering an anchor.....	88
6.10.3	Danforth anchor.....	89
6.10.4	Grapple or reef anchor.....	89
6.10.5	Anchor warp.....	90
6.11	Wind and waves.....	90
6.11.1	Handling a head sea.....	90
6.11.2	Handling a following sea.....	91
6.11.3	Boat wash/wake.....	93

CHAPTER 7

FRB Drills

7.1	Rowing/paddling the FRB.....	95
7.2	Changing the propeller.....	95
7.3	Emergency stop drill.....	96
7.3.1	Broad side turn.....	96
7.3.2	Reverse thrust.....	96
7.4	Throw lines.....	96
7.4.1	Throwing a line.....	96
7.4.2	Throwing a throw bag.....	97
7.5	Defensive swimming.....	98
7.5.1	Holding a rescue rope.....	98
7.5.2	Heat escape lessening position (HELP).....	99
7.5.3	Huddle.....	100
7.5.4	Advanced techniques.....	100
7.6	Recovering survivors from the water.....	101
7.6.1	Leg-over method.....	102
7.6.2	Head-first method.....	102
7.6.3	Feet-first method.....	103
7.6.4	Recovery over the stern.....	104
7.6.5	Basket stretchers.....	105
7.6.6	Recovery boards.....	105
7.6.7	Combination method.....	105
7.7	Overboard drill.....	106
7.8	Capsize drill.....	106
7.8.1	Boat righting.....	106
7.9	Fire drill.....	107
7.10	Distress calls.....	107
7.10.1	Mayday call.....	107
7.10.2	PAN PAN message.....	107
7.11	Distress signals.....	107
7.12	Abandoning the FRB.....	108
7.13	Loading and unloading.....	108
7.13.1	Boat to boat.....	109
7.14	Moving people and animals.....	109
7.14.1	Capacity stickers and compliance plates.....	109
7.14.2	Evacuations.....	110
7.14.3	Passengers.....	110
7.14.4	Evacuating the injured.....	111
7.14.5	Looting.....	111
7.14.6	Transporting animals.....	111
7.15	Moving large livestock.....	112
7.15.1	Taking the call.....	112
7.15.2	Equipment required.....	112

7.15.3	Moving the stock.....	112
7.15.4	Calves and foals.....	114
7.15.5	Other livestock.....	115
7.16	Operating at night and in poor visibility.....	116
7.16.1	Navigation at night.....	116
7.16.2	Night vision.....	116
7.16.3	Observation skills.....	116
7.16.4	Operations in poor visibility.....	117
7.17	Vessels in distress.....	117
7.17.1	Safety.....	117
7.18	Towing boats and debris.....	118
7.18.1	Stern towing.....	118
7.18.2	Barge towing.....	119
7.18.3	Bridles.....	120
7.18.4	Turning.....	121
7.18.5	Crew positions.....	121
7.18.6	Casting off.....	121
7.19	Outboard fault finding.....	121
7.19.1	Drowned motor.....	123
7.19.2	Lost motor.....	123

CHAPTER 8

Inland Water Search and Body Recovery

8.1	Search patterns.....	125
8.1.1	Parallel search.....	125
8.1.2	Track line search.....	126
8.1.3	Expanding square search.....	126
8.1.4	Sector search.....	126
8.2	Underwater search methods.....	127
8.2.1	Probing.....	127
8.2.2	Dragging.....	127
8.2.3	Dragging techniques.....	129
8.2.4	Nets and body fences.....	131
8.3	Locating a body.....	131
8.4	Recovering a body.....	132
8.4.1	Body flotation.....	132
8.4.2	Body submergence time.....	132
8.5	Working with police divers.....	133
8.6	Working with helicopters.....	133
8.6.1	Rotor blades.....	133
8.6.2	Radio antenna.....	133
8.6.3	Static electricity.....	133
8.6.4	Approaching and leaving a helicopter.....	134
8.6.5	Dust and debris.....	135
8.6.6	Landing area procedures.....	135
8.6.7	Night landings.....	135
8.6.8	Winching.....	135
8.7	Tides and currents.....	135
8.7.1	Tides versus currents.....	135
8.7.2	Tidal action.....	136
8.7.3	Terminology of tides.....	136
8.7.4	Tidal information.....	136
8.7.5	Currents.....	136

8.7.6	Terminology of currents	137
8.7.7	Affects of currents	137
8.7.8	Difficult areas	137

CHAPTER 9

Operating in Currents

9.1	Floodwater behaviour	139
9.1.1	The force of water	139
9.1.2	How fast can water flow?	139
9.1.3	River variables	140
9.1.4	Rivers in flood	140
9.2	River hazards	141
9.2.1	River currents	141
9.2.2	Debris	144
9.2.3	River waves	144
9.2.4	Water curl back	146
9.2.5	Eddies	146
9.2.6	Hydraulics and holes/stoppers	147
9.2.7	Smiling and frowning holes/stoppers	149
9.2.8	Whirlpools	149
9.2.9	Rapids	150
9.2.10	Weirs	150
9.2.11	Strainers	151
9.2.12	Bridges	151
9.3	Working in currents	151
9.3.1	A typical river in flood	151
9.3.2	Getting started in a current	152
9.3.3	Travelling in currents	153
9.3.4	Finding a route	154
9.3.5	Turning in currents	155
9.3.6	Eddy turns (breaking in)	155
9.3.7	Eddy peel out turns (breaking out)	156
9.3.8	Crossing currents (ferry angle or ferry glide)	157
9.3.9	Stopping in currents	158
9.3.10	Beaching in currents	158
9.3.11	High siding	158
9.3.12	Crossing a weir	160
9.3.13	Approaching objects in flood	160

CHAPTER 10

Navigation

10.1	Navigation aids	163
10.1.1	Fixed marine compass	163
10.1.2	Charts	163
10.2	Navigation techniques	163
10.2.1	Time-speed-distance triangle	164
10.2.2	Position	164
10.2.3	Navigating while underway	165
	List of shortened forms	166
	Terms and definitions	167
	References and Acknowledgements	170

1.1 Flood rescue boat functions

Major floods affect many areas of Australia, and require response and recovery efforts by emergency services. Flood response is one of the main roles of the State Emergency Service. Flood Rescue Boats (FRBs) and crews are important to this work. FRBs are used for:

- **resupply**—taking food and medical supplies to properties cut off by floodwaters
- **fodder movement**—moving loads of hay to stranded livestock
- **ferrying people**—moving people across a flooded river or flooded land
- **evacuation**—moving people or animals to safety
- **search and recovery**—searching floodwaters for missing people
- **rescue**—rescuing people trapped by floodwaters, such as on car roofs, house roofs or in trees.

These jobs are often done in poor weather, with dirty, debris-carrying water that can flow with great force. In some cases, crews have to work at night.

Crew members' tasks include:

- getting the FRB and trailer ready for operation
- launching the FRB
- driving the FRB
- navigating the FRB
- keeping a lookout
- loading and unloading the FRB
- anchoring or tying the FRB to a bank or jetty
- caring for passengers/casualties
- recovering the FRB
- maintaining the FRB, trailer and motor.

Crew members need to be able to:

- quickly learn how to drive FRBs
- swim and not be unduly afraid of water
- do physical work, for example lifting, winching and starting engines by hand
- work for several hours
- be free of injuries likely to be made worse by this kind of work
- work in the dark
- have a basic understanding of how machinery works
- demonstrate a good sense of direction and some ability to read maps
- demonstrate a good sense of judgment and the ability to see dangers coming.

1.2 Crew requirements

1.2.1 Knowledge

FRB crews should have the following minimum knowledge prior to becoming involved in rescue operations:

- State/Territory boating regulations
- safety rules of boating
- basic principles of seamanship
- knowledge of boats and motors
- basic navigational skills
- knowledge of their own strengths and weaknesses
- local knowledge of the area of involvement
- basic first aid skills.

1.2.2 Licensing and boating regulations

Each State/Territory has different licensing and regulatory requirements. Refer to your State/Territory's regulatory agency to find out more about the requirements in your State/Territory.

1.2.3 Knowledge of boat and motor

FRB operators can never know everything about the boat and motor that they are required to operate in flood conditions. However, they must make every effort to familiarise themselves with the characteristics of the FRB, its limitations and, above all, the handling characteristics of both boat and motor. No two operating areas are the same, and all boats handle differently. The difference can only be learned with practice.

The limitations of any boat are:

- the physical limitations of the boat design and the motor installed
- safety limitations imposed by government regulations and emergency services.

Above all, commonsense is necessary. In addition to the above knowledge, FRB crew members should know the general policy and organisational directives that effect the operation of the FRB.

1.2.4 Working safely, responsibly and professionally

FRB operations are among the most dangerous functions that emergency service personnel undertake.

There is no place for skylarking or reckless behaviour during FRB operations. Such behaviour constitutes dangerous navigation and is against the law.

FRB operators are responsible and accountable for the safety of the FRB, crew and passengers, and they often operate in hazardous conditions. While recreational and commercial boaters have legal limits for alcohol consumption (check your State/Territory marine boating legislation), FRB operators **must not** consume alcohol or take drugs (including legal medicines that cause drowsiness).

1.2.5 Swimming ability

All FRB crew members must be able to swim and tread water. Refer to your agency's Standard Operating Procedures (SOPs) for requirements in your State/Territory.

It is good practice for FRB crew members to wear a personal flotation device (PFD) whenever they are on the water.

1.3 Personal protection

FRB crew members and passengers can be adversely affected by exposure when working in the sun, wind, rain and cold with little or no shelter. Insects can also be a problem. Heat, sunburn and cold can turn crews and passengers into casualties.

1.3.1 Personal protective equipment

FRB crew members must wear appropriate personal protective equipment (PPE) for protection against the elements and the operating environment.

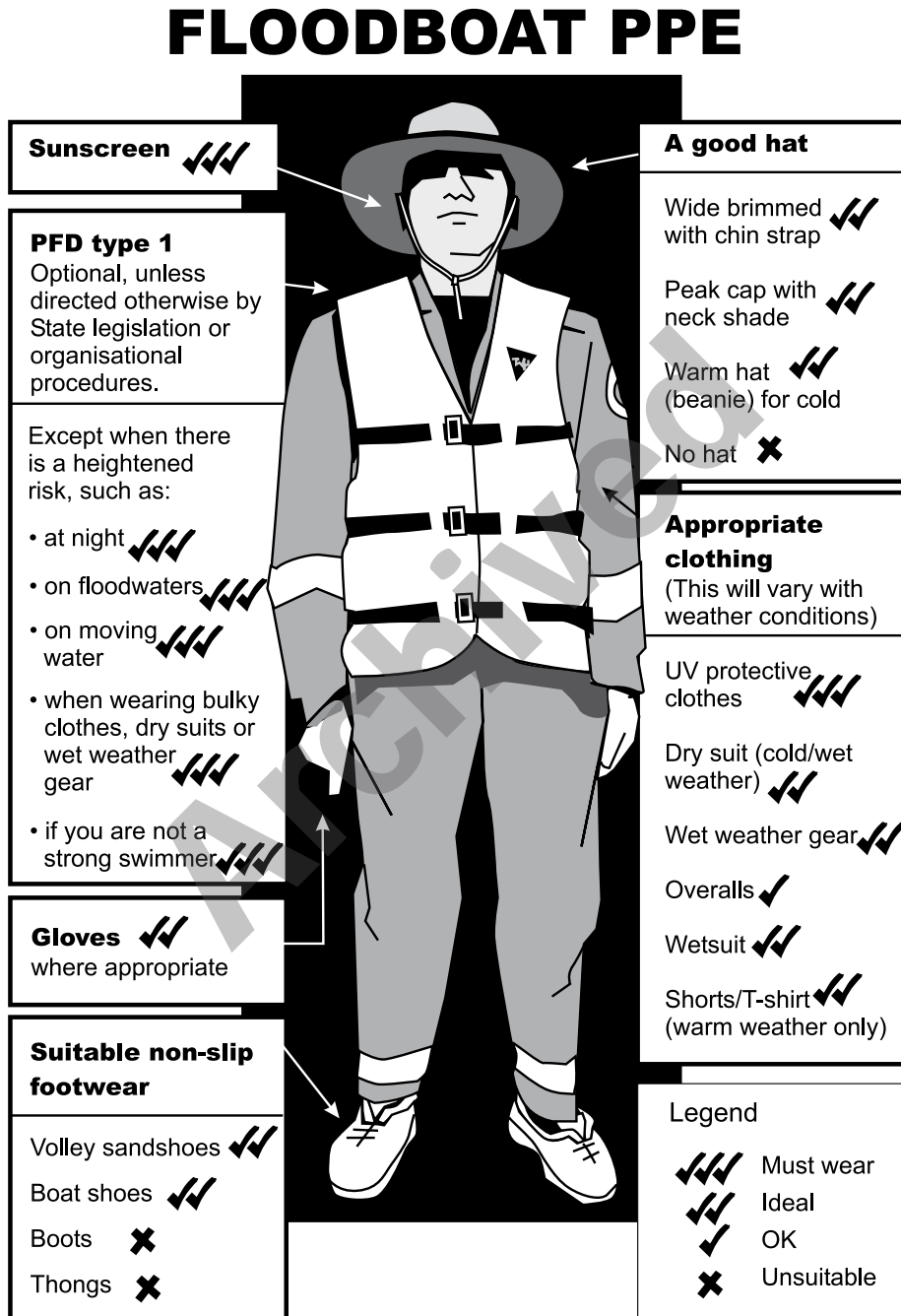

**Remember, there is only one rule here –
BE FLEXIBLE BUT SAFE**

Figure 1:1
FRB personal protective equipment

1.3.2 Heat and sun

It is important for FRB crew members to protect themselves, and their passengers, from exposure to the sun, which could result in severe sunburn, heat stress and heat stroke. Prolonged exposure to the sun can also result in skin cancer and eye cataracts.

When operating in sunny weather, crew members should wear a hat and sunglasses, and dress in loose-fitting and ultraviolet-protective clothing. Sunscreen should also be applied to exposed skin at regular intervals. This is important because of the reflection of the sun off the water. It is also important to drink plenty of water.

Tip: on really hot days wetting hats or clothing in clean water can help FRB crew members or passengers stay cool.

1.3.3 Cold

Cold weather can be extremely uncomfortable and can lead to hypothermia (a serious medical emergency) in crew members or passengers.

To protect from hypothermia, it is important for FRB crew members to:

- wear clothes in layers for easy adjustment in changing temperatures. A good combination is a polar fleece-style tracksuit (perhaps with thermal underwear underneath) with an extra jumper and a standard set of wet weather gear over the top for wind/rain/splash protection. A drysuit with a tracksuit and/or thermal underwear is an alternative.
- wear a warm hat (for example, a beanie or balaclava) and warm gloves
- avoid getting unnecessarily wet from boat spray and rain, and to take extra care not to fall into the water
- avoid unnecessary wading during launching, recovery and beaching
- carry blankets in the FRB to keep casualties warm.

Important: FRB crews must know basic first aid to be able to identify and care for people suffering from overexposure to heat and cold.

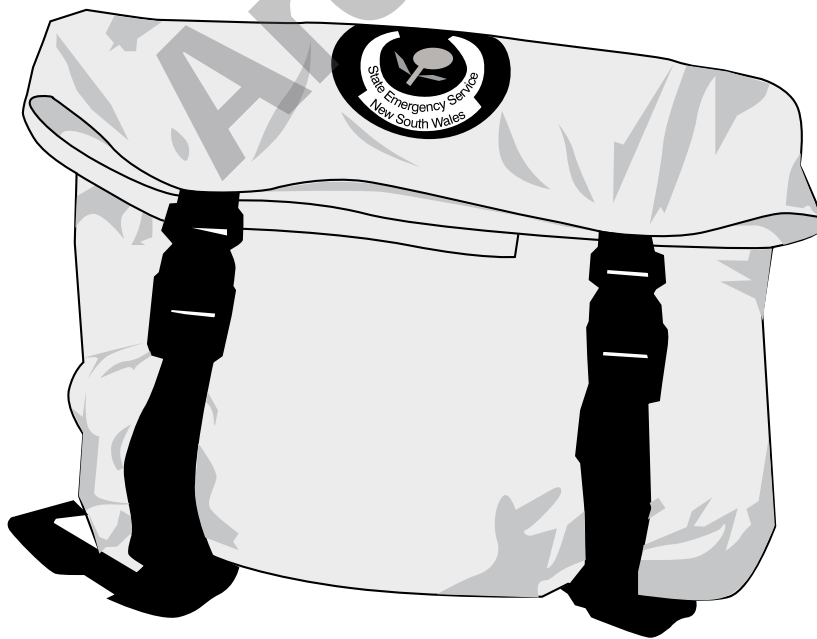

Figure 1:2
FRB first aid kit

1.3.4 Fatigue

Crew members need to take regular breaks and work realistic shift lengths to avoid fatigue and to maintain safe boat operations. Crew members must consider how long they have worked in total since the start of the day (normal job, driving, other daily activities) prior to undertaking FRB operations.

Sensible shifts need to be established (that is, a maximum 8–12 hours). Shifts may need to be shorter if crew members worked before the operation. At the end of a shift, crews must do a thorough handover to the next shift.

Crews need to take breaks at the end of an operation or during long operations. Food and drinks are necessary at breaks and should be carried on long operations.

1.3.5 Contaminated water

Floodwater picks up contamination, including dead animals, animal faeces, and human sewage from flooded septic tanks and sewers. Crew members should avoid wading or swimming in floodwaters or getting spray in their mouths. Crew members should wash their hands in clean water before eating or putting their fingers anywhere where germs can enter the body (for example, mouth, eyes, nose). Crew members should also wash and change their clothes regularly when working in contaminated water.

1.3.6 Insects

Crew members should use insect repellent to protect from diseases carried by insects (for example, Ross River virus).

1.3.7 Critical incidents

Many emergency services have critical incident support programs to help reduce the effects of critical incidents on emergency personnel. FRB crews should ensure they call their State/Territory's critical incident support number when responding to anything likely to affect crew members (for example, a body recovery). This can often be done before an operation so a peer support person can be on hand at the end to talk to the crew.

1.4 Crew positions

A FRB crew normally consists of a person in command and one or more crew members who must be qualified to hold their respective positions. Check your State/Territory's qualification requirements for these positions.

FRB crew positions include:

- the crew leader/master—the person in command
- crew members— these may be trained members or untrained members under supervision
- the coxswain—the person who drives the FRB, which may be the crew leader/master or a crew member under supervision.

1.4.1 Minimum number of crew members

A minimum of two qualified people (crew leader/master and a qualified crew member) must be in the FRB when in operation. This includes very short trips, such as moving the boat from a boat ramp to a nearby beach or driving a boat from a trailer.

1.4.2 Responsibilities of the crew

The crew leader/master, the person in command, is responsible for:

- doing a risk assessment before going out on an operation
- the safety of the crew, passengers, cargo and the FRB
- briefing and debriefing the crew and passengers
- the completion and quality of operations/tasks
- assessing, organising, leading and reviewing operations
- completing operation/incident reports
- reporting accidents and near-miss incidents.

Crew members are responsible for:

- working safely to the standard to which they have been trained
- respecting and following reasonable instructions made by the person in command
- reporting to the person in command
- ensuring the FRB is ready for each day's operation
- handling lines and stowing equipment safely within the FRB
- operating any communications equipment carried in the FRB
- acting as lookouts while underway
- control the loading of any passengers and cargo
- reporting accidents and near-miss incidents.

The coxswain is responsible for:

- driving the FRB safely, professionally and legally
- following the directions of the person in command.

WARNING

The coxswain must have the kill switch lanyard attached to them at all times when the motor is running (refer to section 2.4.3).

1.4.3 Accident and near-miss reports

The person in command is responsible for reporting any accidents or near-miss incidents. Any time a FRB or crew member is involved in an accident or near-miss incident, the event **must** be reported to State/Territory headquarters in accordance with agency incident reporting systems/SOPs.

Reporting accidents and near misses is vital for the identification of problems in operational procedures, training and equipment. For example, many accidents and near misses involving a particular type of FRB went unreported over a two-year period, and injuries could have been avoided if the problem had been reported the first time it happened. Once reported, a significant boat-handling problem was identified and corrective measures were taken.

Reporting requirements involve:

- **what**—an outline of what happened
- **when**—the date and time of the incident
- **where**—where it happened
- **who**—who was involved, including any independent witnesses
- **why**—opinions of why the incident may have happened
- **how**—recommendations about how a similar incident could be avoided in the future.

1.4.4 Final decision

Important: the person in command always has the final decision on the FRB during a task.

The person in command is guided by the:

- urgency of the task
- prevailing conditions
- suitability of the FRB and equipment
- experience and abilities of the crew and himself/herself.

Archived

End of chapter. This page left intentionally blank.

Archived

2.1 The boat

Figure 2:1 shows common boat terminology.

The front of the boat is the **bow** and the rear is the **stern**.

The boat is driven **ahead** (forwards) or **astern** (in reverse), and it is steered to **port** (left) or **starboard** (right).

Objects outside the boat are described as being seen off the port or starboard bow, beam or quarter (for example, the house is off the starboard bow).

Crew and passengers are described as sitting **forward** or **aft** within the boat.

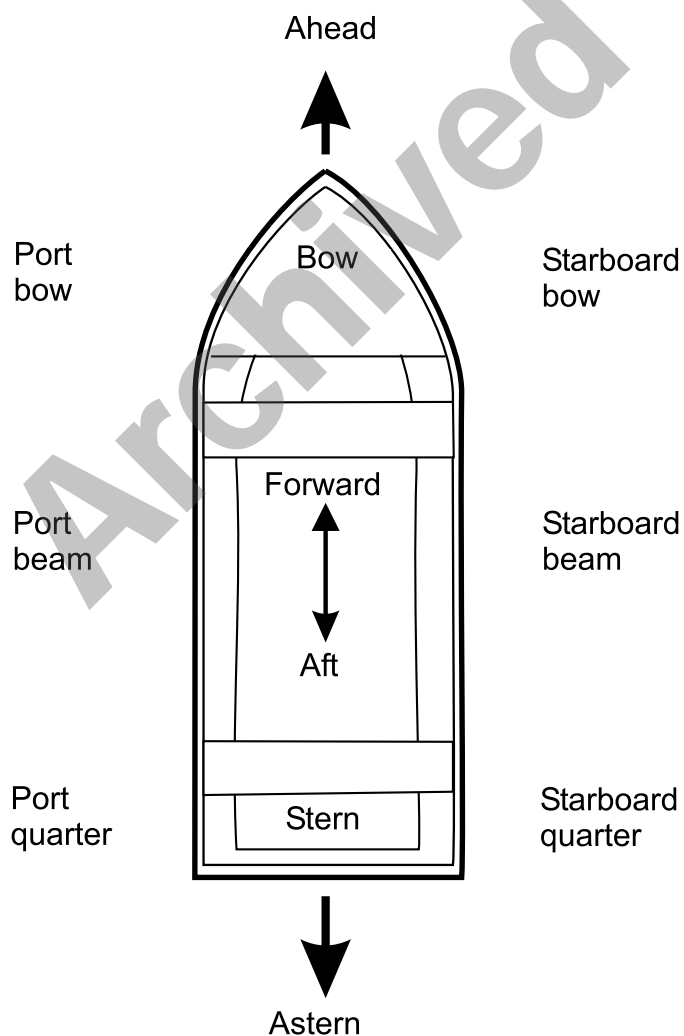

Figure 2:1
Boat terms

2.1.1 Parts of a boat

Crew members must know the parts of their boat for safety and for accurate communication.

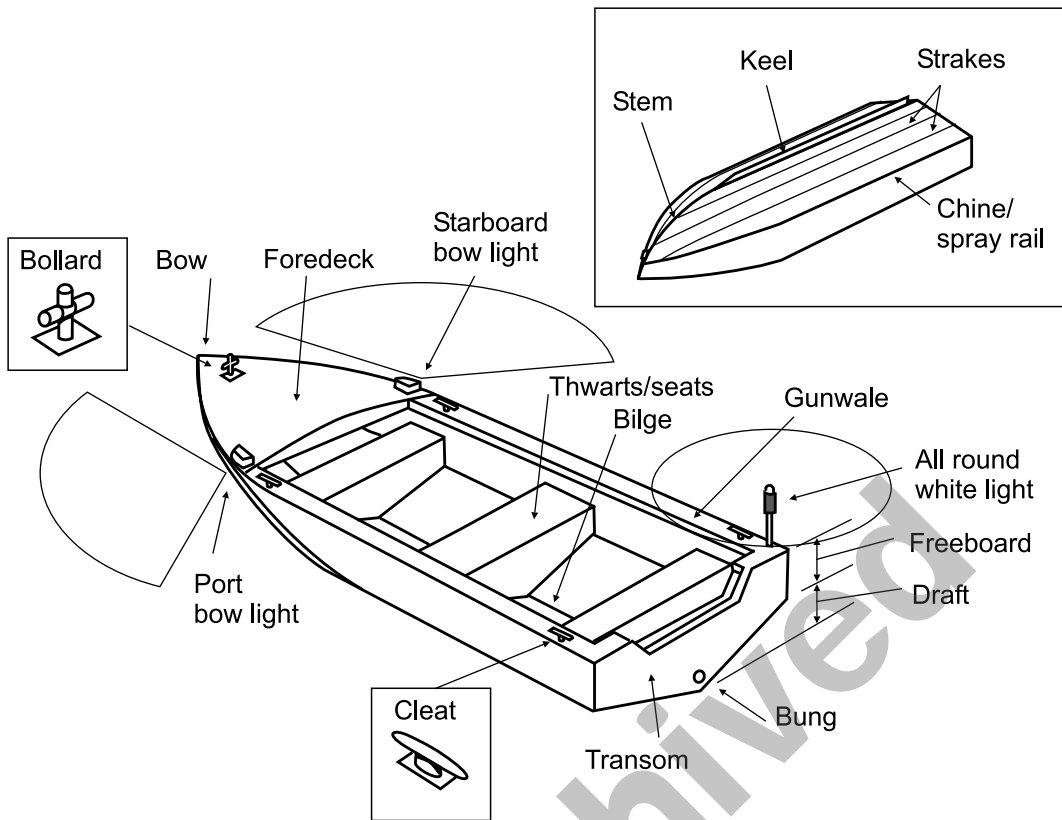

Figure 2:2
Parts of a boat

2.2 The hull

2.2.1 Hull types

The emergency services have several types of FRBs, which have different hull types.

For general operations, the following FRBs and hull types are used:

- V-nosed punt
- shallow V-hull
- moderate V-hull.

For specialist operations, the following types of FRBs are used:

- inflatable rubber boat (IRB)
- rigid inflatable boat (RIB)
- large punt
- catamaran or multi-hull.

The characteristics of the common hull types are shown in the following figures.

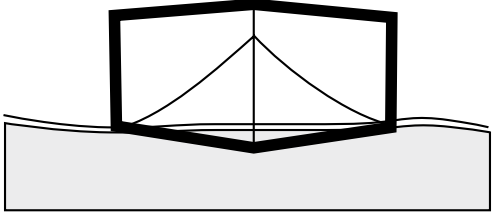
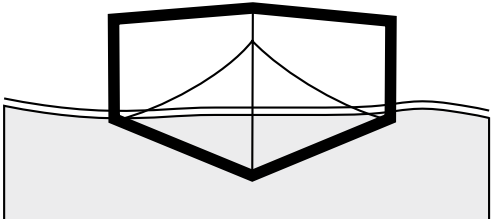
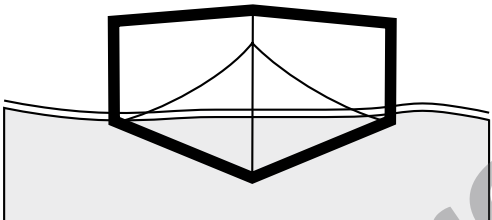
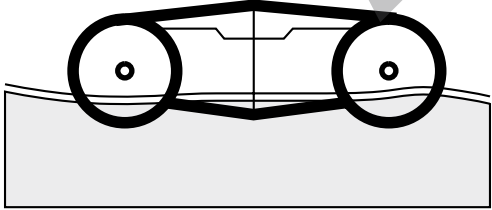
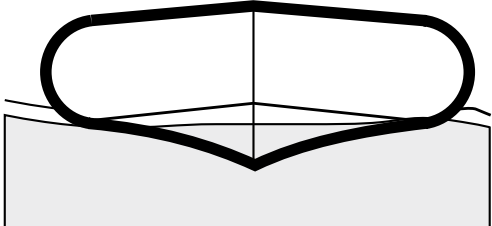
HULL TYPE	CHARACTERISTICS
<p>Shallow V and V-nosed punt</p>  <p>Figure 2:3</p>	<p>May pound in rough conditions.</p> <p>Very stable.</p> <p>Good weight-carrying capacity.</p> <p>Needs less power to plane.</p> <p>Recommended for shallow, flowing water.</p> <p>May skate in turns.</p>
<p>Moderate V</p>  <p>Figure 2:4</p>	<p>Less pounding in rough conditions than the shallow V.</p> <p>Less stable than the shallow V and V-nosed punt.</p> <p>Turns tighter than the shallow V and V-nosed punt.</p> <p>Recommended for deep water.</p>
<p>Deep V</p>  <p>Figure 2:5</p>	<p>Rides well in rough water.</p> <p>Least stable at rest.</p> <p>Turns tightly.</p> <p>Requires more power to run.</p> <p>Carries less weight.</p>
<p>Inflatable rubber boat (IRB)</p>  <p>Figure 2:6</p>	<p>Used in shallow water.</p> <p>Can be easily transported to difficult locations.</p> <p>Heavy pounding in rough waters.</p> <p>Stable.</p> <p>Positive buoyancy.</p>
<p>Rigid inflatable boat (RIB)</p>  <p>Figure 2:7</p>	<p>Not recommended for shallow water.</p> <p>Less pounding than IRBs.</p> <p>Needs more power to drive than IRBs.</p> <p>Stable.</p> <p>Positive buoyancy.</p>

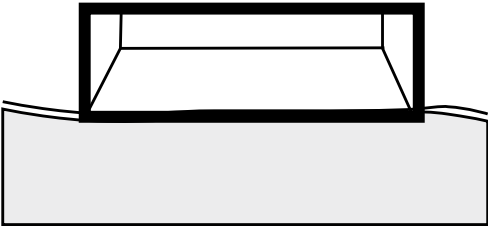
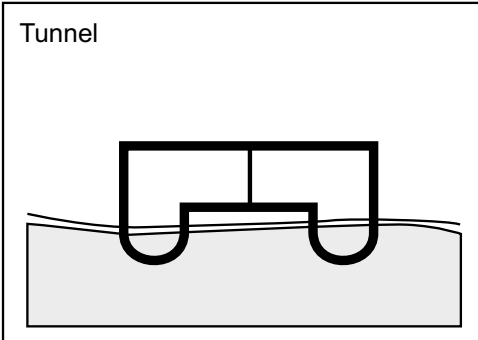
HULL TYPE	CHARACTERISTICS
<p>Punt</p>  <p>Figure 2:8</p>	<p>Good stability.</p> <p>Less manoeuvrable than V-hulls.</p> <p>Will pound in rough water.</p> <p>Tends to drive itself under waves.</p> <p>Not recommended in fast-flowing currents.</p>
<p>Catamaran or multi-hull</p> <p>Tunnel</p>  <p>Figure 2:9</p>	<p>Soft riding/little pounding.</p> <p>Stable.</p> <p>More power required to propel.</p> <p>Greater draft than V-hulls and punts.</p>

Did you know?

FRBs have planing hulls. These allow the boat to get up on top of the water and skim over it at high speeds. A heavily loaded FRB with a planing hull may behave like a boat with a displacement hull, which means that it will push through the water and have a much lower top speed.

2.2.2 Hull maintenance

FRBs must be maintained regularly in accordance with agency SOPs. The FRB should be cleaned regularly and inspected for damage such as corrosion, loose fittings, deterioration of anodes and dents. All defects must be reported.

Major damage must be repaired professionally but minor repairs like patching paintwork or knocking out small dents can be done by the crew.

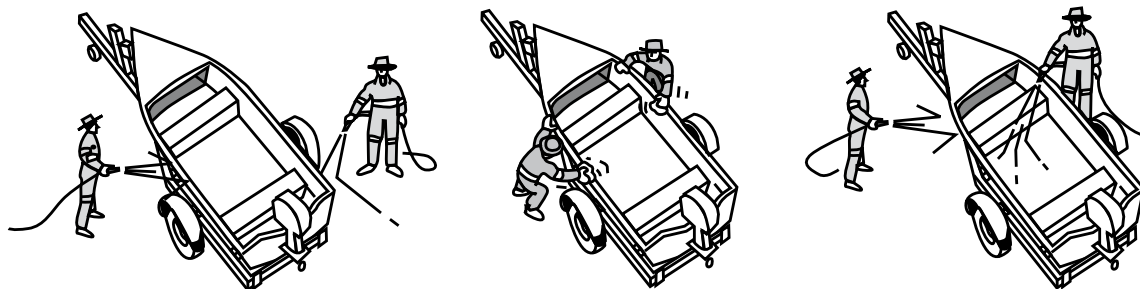

Figure 2:10
Hull maintenance

Before garaging a FRB, prepare the boat for storage:

- open hatches and spread items like PFDs out where they can air
- store the FRB inside, with the bow elevated and the bungs out
- turn off or disconnect the battery
- remove the fuel hose from the motor and close the fuel tank breathers.

2.2.3 New fittings

Electrolysis can be a major problem in aluminium boats. This occurs where dissimilar metals come into contact with each other. Where possible, use stainless steel, aluminium or plastic marine-grade fittings and avoid using fittings that are made of ferrous metals such as brass and copper.

Did you know?

Aluminium hulls corrode. Remove anything that is dropped in the FRB (for example, small tools, nuts, bolts and washers). Dissimilar metals react with each other, the worst of these being lead (commonly found in sinkers).

2.3 The motor

FRBs have a variety of designs and intended uses and, as such, require different types of propulsion.

Most FRBs are less than six metres in length and are propelled by outboard motors. Outboard motors are ideal for smaller boats. They are light and powerful and the modern outboard motors are extremely quiet.

Outboard motors provide a completely self-contained propulsion system from engine to transmission to shaft and propeller. They are most often mounted directly on the transom of the boat. However, some boat designs incorporate a motor well or bracket on which the motor is mounted. As the turning propeller pushes the stern, the entire motor swivels about to provide easy steering.

Outboard motors come in a large range of sizes, numbers of cylinders and horsepower, and can use different fuel sources. Different types of outboard motors are:

- small electric trolling motors
- pre mix (petrol and oil-mixture) two-stroke engines
- oil injected two stroke engines
- four-stroke engines
- diesel-powered outboards
- direct-injected two-stroke engines.

Most emergency services use two-stroke and four-stroke outboard motors.

Outboard motors work better if used regularly. Avoid long periods of non-use. If stored outside, the motors should be covered. If a boat is left in the water for a long period of time, raise the motor so the water intake is clear of the water to prevent clogging from silt and weed.

2.3.1 Parts of an outboard motor

Basic knowledge of motor systems helps when operating motors and fixing problems.

The parts of most motors are similar. Crew members should familiarise themselves with the motors of their FRBs (see Figure 2.11).

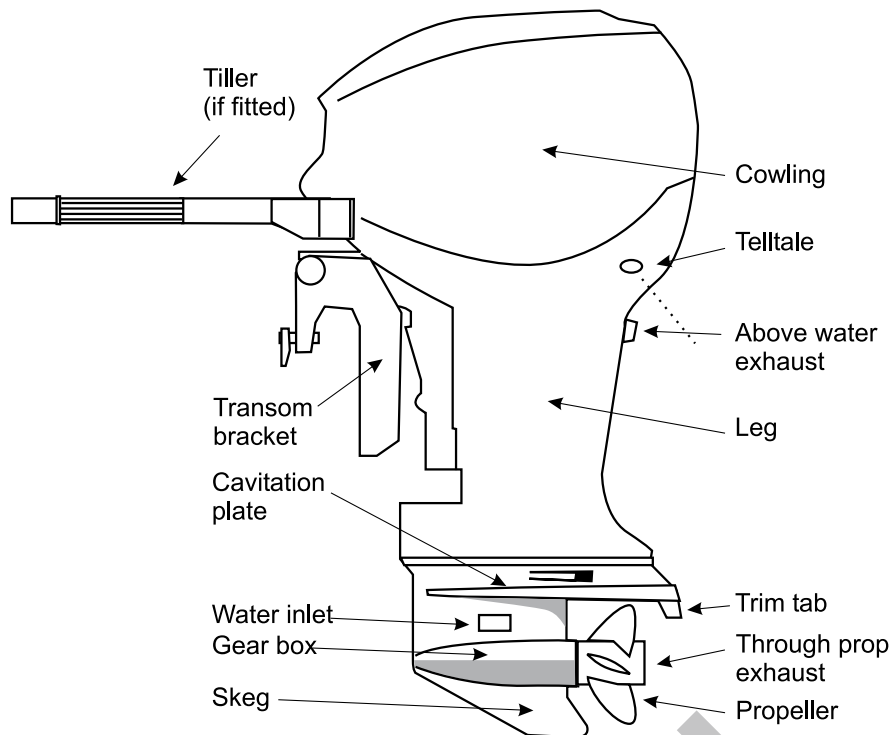

Figure 2:11
Outboard motor parts

2.3.2 The ignition system

The ignition system produces electricity, which fires through spark plugs and ignites the fuel/air mix in the combustion chamber of the motor.

2.3.3 The cooling system

Outboard motors use the water in which they operate to take away heat from combustion. If the cooling system fails, it can damage or destroy the motor.

A water pump sucks water in through intakes on the leg of the motor and pumps it around water jackets inside the powerhead (the engine) to absorb waste heat. Some of this water comes out of the telltale and is visible to show that the water pump is working. The rest of the heated water is often dumped into the exhaust. Check the telltale often to see it is still running. If it is not, stop the motor and check the water intake—it may be fouled with weeds or a plastic bag.

After running a motor in salt or dirty water, always flush the cooling system with clean, fresh water to prevent the motor from corroding.

Check the owner's manual to see if there is an alarm for overheating and what this sounds like. Some outboard motors also have a system that limits an engine's revs if it is overheated.

Did you know?

The water pump impeller needs water for lubrication and can be destroyed in fewer than seven seconds if the motor is run dry. Never start the engine out of the water unless using a hose and muffs.

2.3.4 The fuel system

The motor's fuel pump sucks fuel from the fuel tank and carries it through the fuel line to the carburetors or fuel injection system. Make sure that the arrow on the priming bulb is pointing towards the motor. The fuel usually passes through a water separator (in the boat) and a fuel filter on the side of the powerhead. The carburettor (fuel injection system) then mixes fuel with air and delivers it to the cylinders, where it is combusted to make power.

2.3.5 Lubricating oil

All petrol motors need lubricating oil to avoid damaging the motor.

A four-stroke motor has an engine oil sump that uses four-stroke engine oil.

Check the owner's manual for:

- how to check the oil level
- recommended oil
- oil change periods
- the unleaded fuel octane rating required.

Two-stroke motors do not have an oil sump but are lubricated by oil that is mixed in the fuel. They use special outboard motor two-stroke oil and it is either oil-injected or premixed.

Oil injection systems automatically mix the fuel:oil ratio. Motors with these systems have an oil tank located in the boat or under the motor cowling. Check the owner's manual for:

- recommended oil
- low-oil alarm sound
- the unleaded fuel octane rating required.

Premix systems require the fuel and oil to be premixed manually. Check the owner's manual for the correct fuel:oil ratio. As an example, a mix of 50:1 means that 50 litres of fuel needs a litre of oil (or each litre of fuel needs 20 ml of oil). So, if eight litres of fuel are needed, the oil required is 8 x 20 ml, which equals 160 ml of oil.

Write the fuel mix (as per the owner's manual) on the fuel tank in big, bold letters with a permanent marker and carry spare oil for long operations.

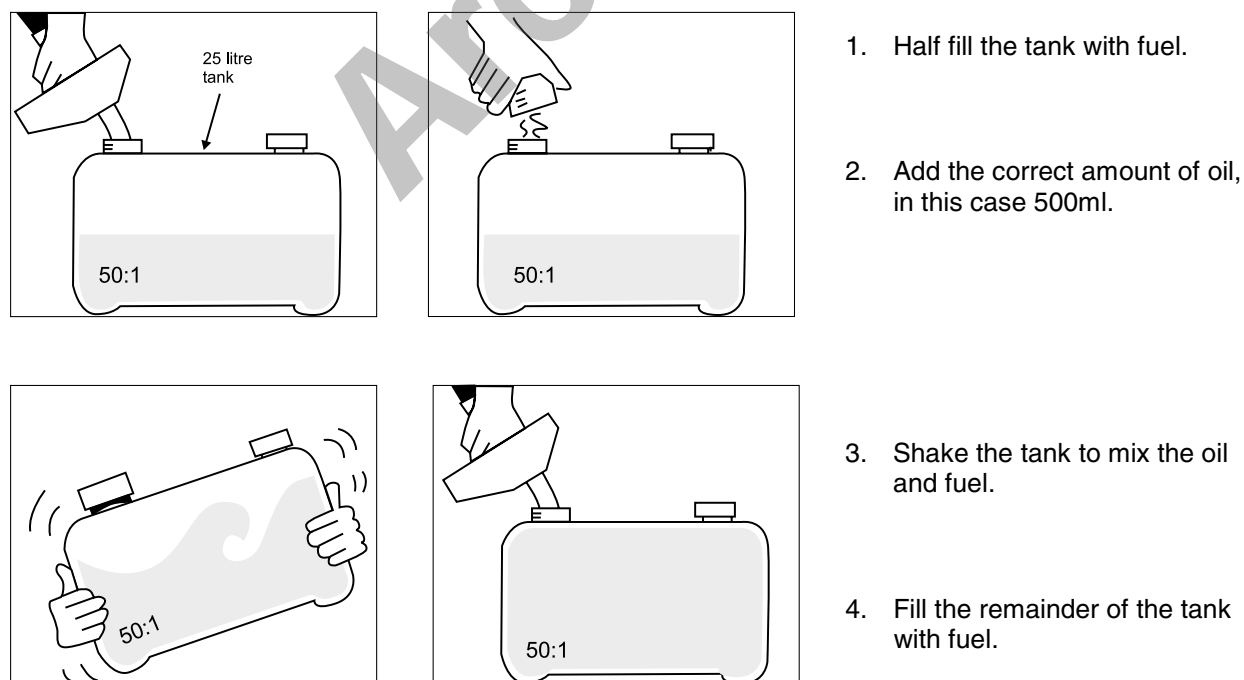

Figure 2:12
Mixing fuel

2.3.6 Guard against fire

Petrol fires on boats spread quickly and are extremely dangerous and difficult to extinguish.

Crews need to **prevent** fires rather than **fight** them.

WARNING

Do not fill fuel tanks in the FRB.

Smoking or using naked flames is not permitted in FRBs.

Where possible, take the tanks out of the boat when fuelling, as vapour is heavier than air and could fill the bottom of the boat. This could cause a fire or explosion.

To prevent fires always:

- clean fuel and oil spills quickly
- check the fuel system regularly for leaks
- check the electrical system for faults and keep all parts clean
- carry the correct fire extinguisher for petrol fires. Ensure it is checked and serviced as required.

2.3.7 The gearbox

The powerhead at the top of the outboard motors turns a vertical shaft that runs down to the gearbox, which is located in a torpedo-shaped housing in front of the propeller. The gearbox has forward, neutral and reverse positions.

The gearbox contains gear oil, which needs to be changed professionally when the motor is serviced. Regularly check the gearbox oil for water contamination. The oil will look milky if it has water in it.

2.3.8 Propellers

The propeller has two roles—it operates like both the wheels and the gearbox of a car. Propellers provide thrust to push the boat forward or pull it in reverse, just like the wheels of a car. Choosing the pitch for a propeller is like selecting a gear in a car. For example, selecting a **low gear** when the car is loaded, towing or going uphill is just like selecting a **low pitch** propeller for a boat when it is loaded, working against currents or towing.

2.3.9 Understanding propeller pitch

FRBs are operated in a variety of circumstances, from training on flat and still water, to operating in fast-flowing and rough floodwaters. For this reason every boat should have a selection of propellers (gears). To successfully select the correct propeller for the FRB operation, the coxswain needs to understand the meaning and application of propeller pitch and diameter, and their effects.

The lower the pitch of the propeller, the better the load-carrying ability. However, the motor will reach maximum revolutions per minute (rpm) at slower speeds, and the boat will not be able to travel as quickly. Conversely, a higher gear/pitch will deliver higher top speeds but slower acceleration.

For example, when the FRB is loaded with heavy cargo or extra people, a low-pitch propeller (with a greater diameter) may be required. When more speed is required, a higher-pitch propeller (with a lesser diameter) is better.

Every one inch of pitch is worth about 200 rpm. Lowering the pitch increases rpm and vice versa. For example, going from a 17 pitch to a 15 pitch will increase motor revs by about 400 rpm at full throttle. Do not over-rev the motor when using a lower-pitch propeller. Check the owner's manual for the maximum revs of the motor.

Did you know?

A propeller's diameter is measured across the circle made by the blade tips. The diameter of a propeller usually increases for propellers used on slower boats and decreases for faster boats.

The pitch of a propeller is the distance in inches a propeller would move in one revolution as if it were being screwed through wood (for example, a 17 pitch propeller would move forward 17 inches in one revolution).

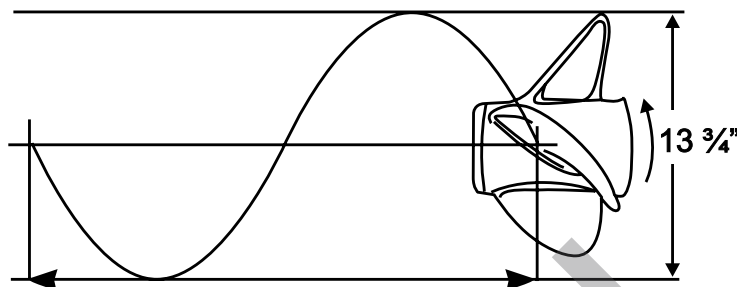

Figure 2:13
Propeller pitch

2.3.10 Propeller types

There are many different propeller types and shapes. The three main materials used to make them are:

- **aluminium**—these propellers are best for FRBs, even though they are slightly less efficient than stainless steel propellers (because the blade can flex under load). The big advantages of aluminium propellers are that they are cheap to replace, and if the propeller hits something the aluminium will tear easily and not transfer the shock into the gearbox and damage gears.
- **stainless steel**—these propellers are very efficient and are much sturdier; however, in the event of a large impact, they are likely to damage the gearbox, leaving crew members and passengers stranded
- **composite materials (plastic)**—composite materials are similar to aluminium in performance and offer the same gearbox protection but they are not as cost-effective as aluminium.

2.4 The controls

Figure 2:14 shows the different types of controls used in boats.

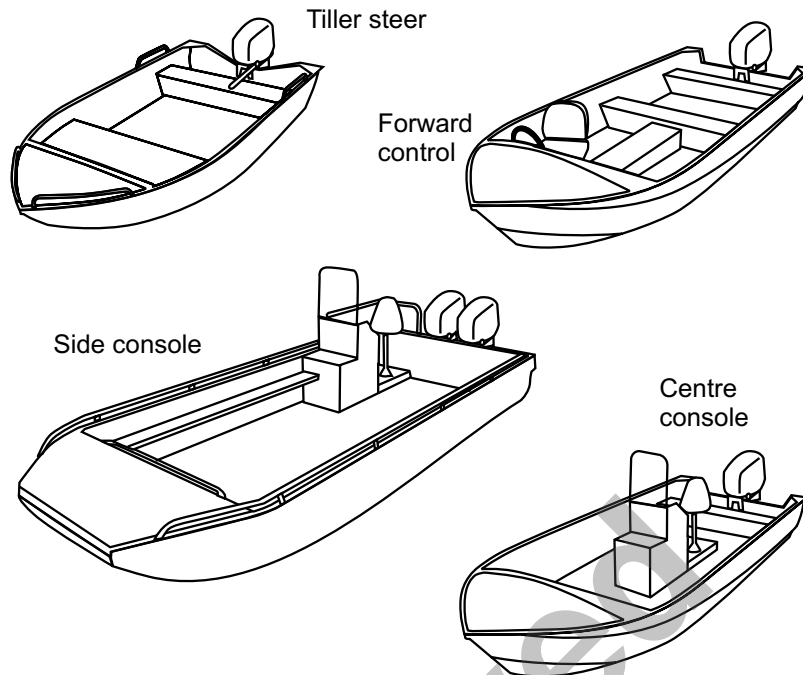

Figure 2:14
Control types

2.4.1 Boats with forward controls

Modern forward controls have a combination throttle and gear lever, which is operated by:

- pushing the lever forward to select forward gear and accelerate the motor
- pulling the lever back to engage reverse gear and accelerate the motor.

Forward controls have a neutral locking position. When the throttle lever is in neutral, it cannot be pushed forward or back without disengaging the neutral lock. This unlocking mechanism is located in the throttle lever handle.

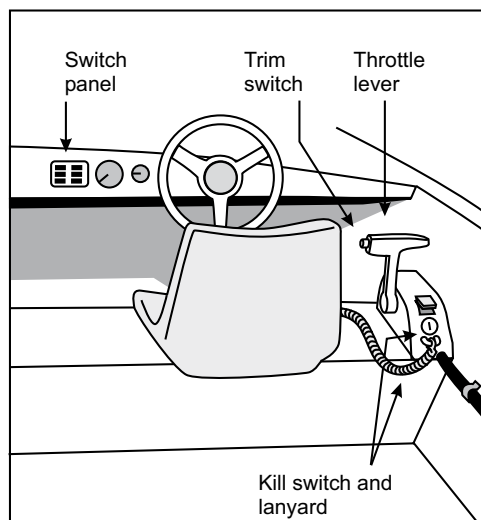

Figure 2:15
Forward control

WARNING

Do not depress the neutral lock release device when bringing the throttle lever back to neutral. Doing this allows the motor to go straight into the opposite gear, which may damage the gearbox.

2.4.2 Motors with tiller controls

Motors with tiller controls have a twist-grip throttle on the end of the tiller (similar to a motorbike) and a variety of gear options. Some have a combination twist-grip throttle and gear selector. Twisting the throttle one way engages forward gear and accelerates the motor; twisting it the opposite way engages reverse gear and accelerates the motor.

Other tiller control motors have the gear control lever on the side of the motor or at the front of the motor cowling. Check the owner's manual for more information on the motor.

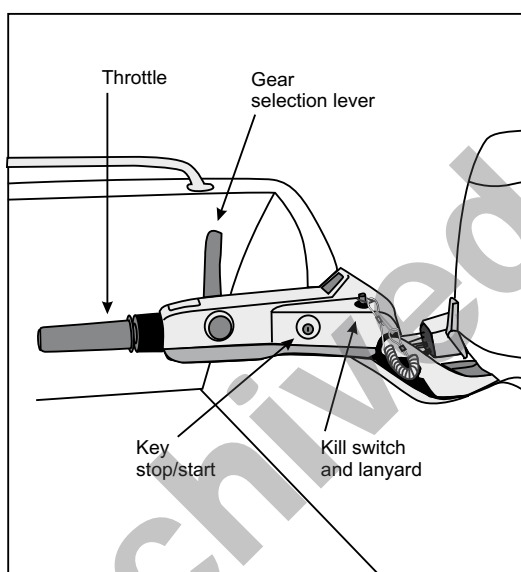

Figure 2:16
Tiller control

2.4.3 Kill switch lanyard

A kill switch is an essential safety item and should be clipped to the coxswain's PFD or wrist at all times when operating a boat. If an accident occurs and the coxswain is thrown from the operating position, the stop switch lanyard is pulled out of its socket/switch, which cuts the motor. It helps prevent injuries by stopping the motor, boat and propeller.

Important: crew members should know how the kill switch system works in their FRB. Some systems need the lanyard to be replaced before the motor can be restarted, while others don't. Always carry spare lanyards.

2.4.4 Motor trim and tilt system

Outboard motors are fitted with either a manual or an electric trim and tilt system.

The trim system allows the operator to set the outboard motor so the boat performs efficiently. Trimming in holds the bow of the boat down and trimming out lifts the bow of the boat (refer to section 6.4.5).

The tilt system allows the motor to be tilted for operating in shallow water, and to be tilted out of the water for transport, servicing and to clear objects in the water.

Trim and tilt systems (especially manual systems) are different for each motor. It is important that crew members check the owner's manual and learn how the trim and tilt system works on their FRB.

2.4.5 Motor mounting

If the motor is mounted incorrectly, it reduces efficiency. If the propeller is too close to the water's surface, air is mixed with the water, which causes the propeller to **cavitate**. Cavitation greatly reduces the power output of the motor: the boat slows down and the motor over-revs (just like spinning the wheels of a car). If the propeller is too deep it causes unnecessary drag and reduces the boat's draft.

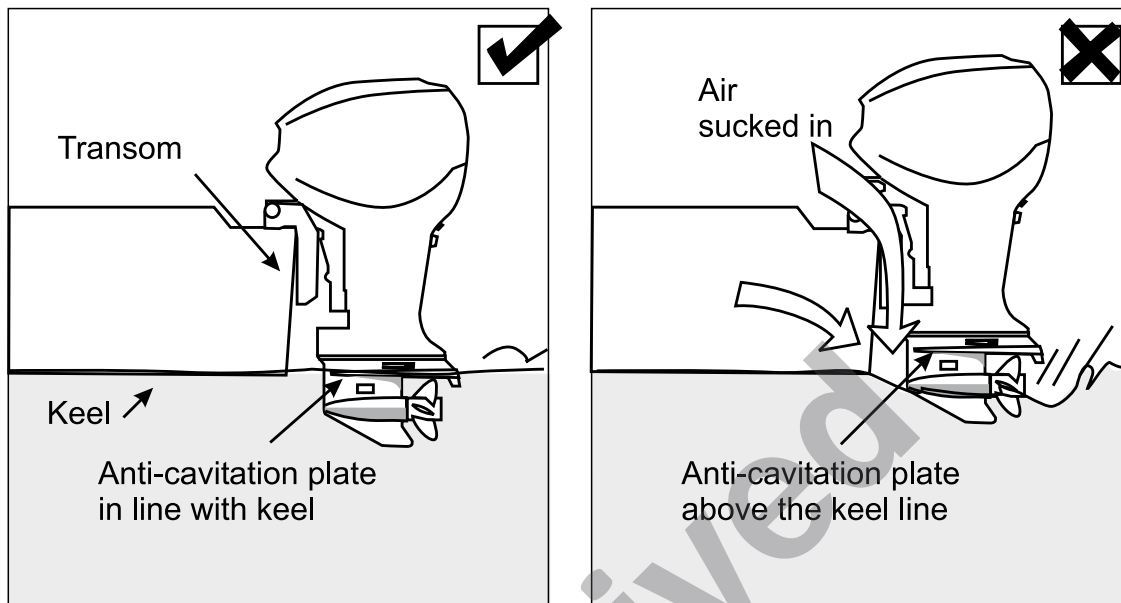

Figure 2:17
Motor mounting

2.4.6 Motor maintenance

The first step in motor maintenance is to read the owner's manual and check the recommended maintenance schedule.

FRB crew members should carry out basic motor maintenance checks regularly. They should also ensure that the motor is serviced by a qualified outboard motor mechanic as per the service schedule in the owner's manual.

Salt and sand build-up in and around the motor can cause problems. Some of these problems can be fixed by washing the exterior with warm soapy water and flushing the cooling system with fresh water after each use. This is critical in the case of engines that are run in saltwater, as it prevents the possibility of damaging salt deposits accumulating inside the engine. Accumulations of salt attract moisture, which accelerates corrosion, especially if left to sit for an extended period.

To flush an engine:

- place the muffs firmly and completely over the intake grills on the leg
- connect a hose to the muffs
- turn the water on full and then start the engine and leave it to idle until the water at the telltale is warm.

Outboard motors have sacrificial anodes, which sacrifice themselves if there is electrolysis activity. These anodes are zinc blocks that are designed to erode (rather than parts of the motor eroding). The anodes are sometimes blocks that are bolted to the trim bracket or on the leg of the outboard. The trim tab is sometimes an anode. Check the anodes regularly for excessive deterioration and replace as needed. Do not paint over anodes, as this will stop them from working.

2.5 The trailer

2.5.1 Types of trailers

Three types of FRB trailers are:

- trailers with bilge strakes
- trailers with multi rollers
- punt slide trailers.

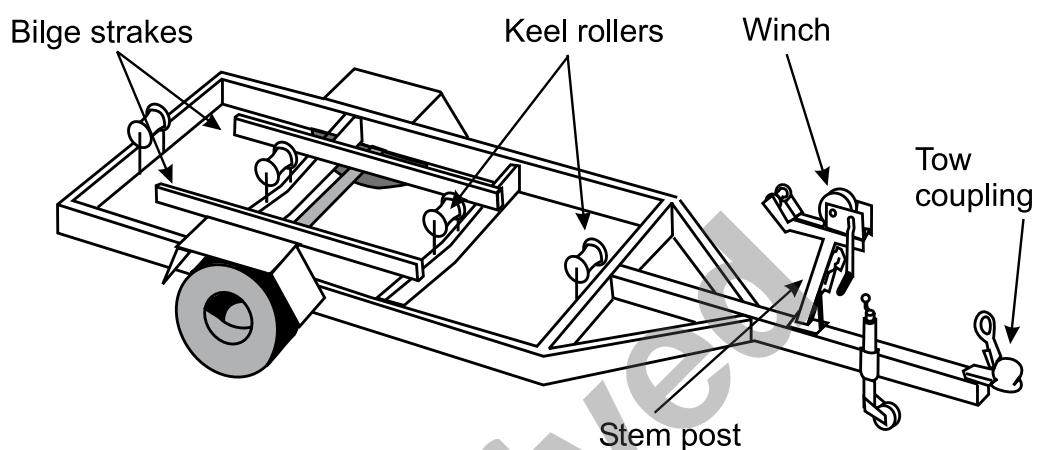

Figure 2:18

Trailer with bilge strakes

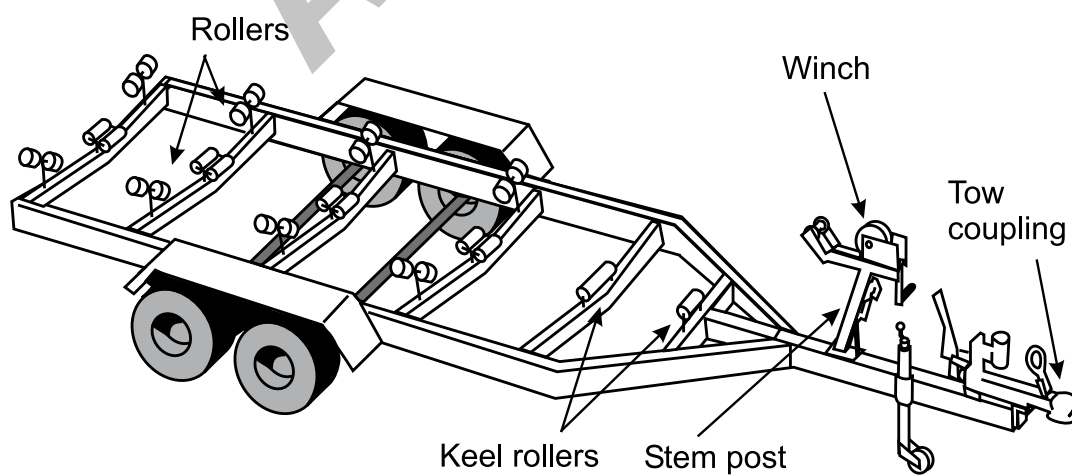

Figure 2:19

Trailer with multi rollers

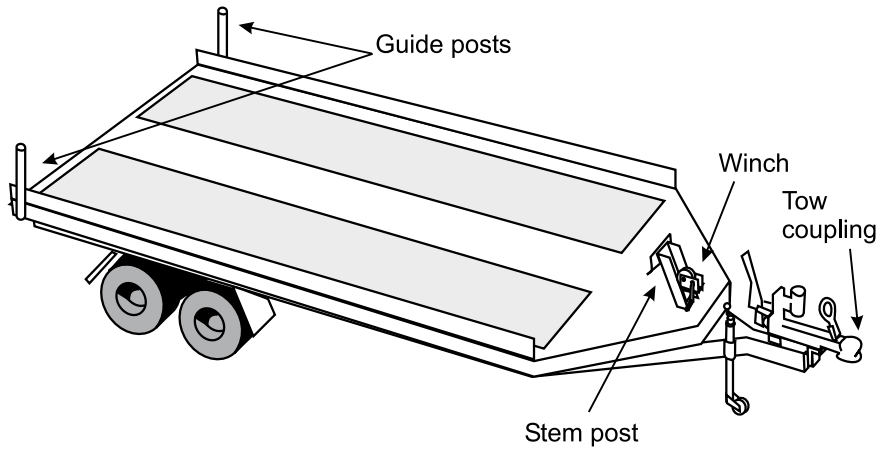

Figure 2:20
Punt slide trailer

Some trailers have tilt mechanisms to make it easier to winch the boat onto the trailer.

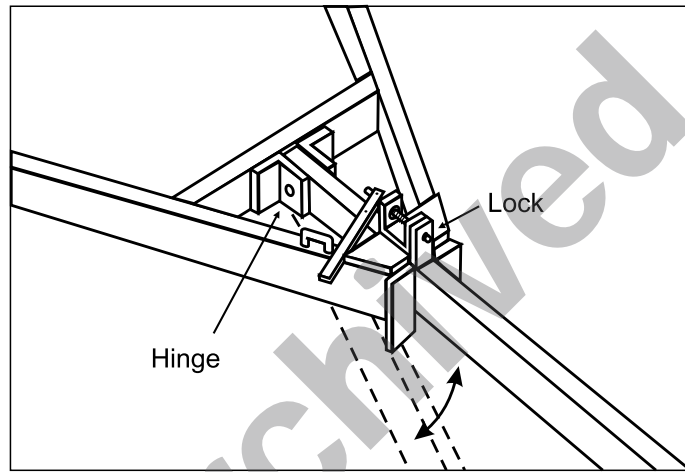

Figure 2:21
Trailer tilt mechanism

Some trailers have motor supports for towing boats long distances.

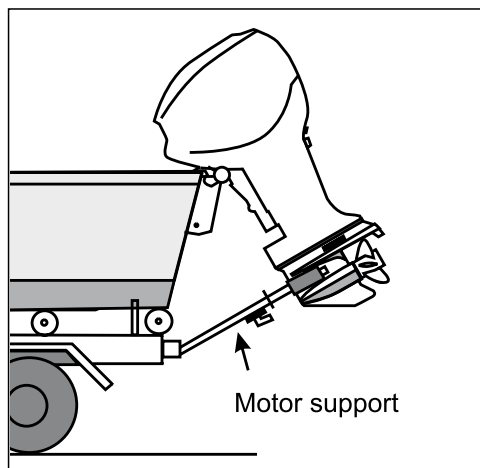

Figure 2:22
Trailer motor support

2.5.2 Trailer maintenance

Boat trailers need regular maintenance and the brakes and wheel bearings should be checked regularly and serviced every 12 months.

2.5.3 Trailer adjustment

The trailer should be adjusted to fit the boat and to ensure the balance of the trailer is correct. The position of the stem post or the axle can be adjusted to change the weight distribution of the boat on the trailer. There should be about 60–80 kg of weight on the tow bar. This downward pressure helps the towing vehicle's brakes by increasing traction on the rear wheels of the towing vehicle.

A well-balanced trailer should be able to be lifted by one person at the tow coupling. If the trailer is heavy to lift at the coupling, the weight is too far forward. If there is no weight on the coupling, the weight is too far back.

On a trailer with multi rollers, the boat needs to be supported evenly by the keel rollers, or multi rollers. All keel rollers must be adjusted to allow the boat load to be distributed evenly.

Trailers with bilge strakes are adjusted to brace the boat against lateral movement, but no weight should be carried on the strakes. Weight on the strakes makes the boat harder to recover and the boat may shift off the keel rollers. A properly adjusted trailer carries its boat on an even keel with the bow winched firmly against the stem post and the transom supported by the rear roller.

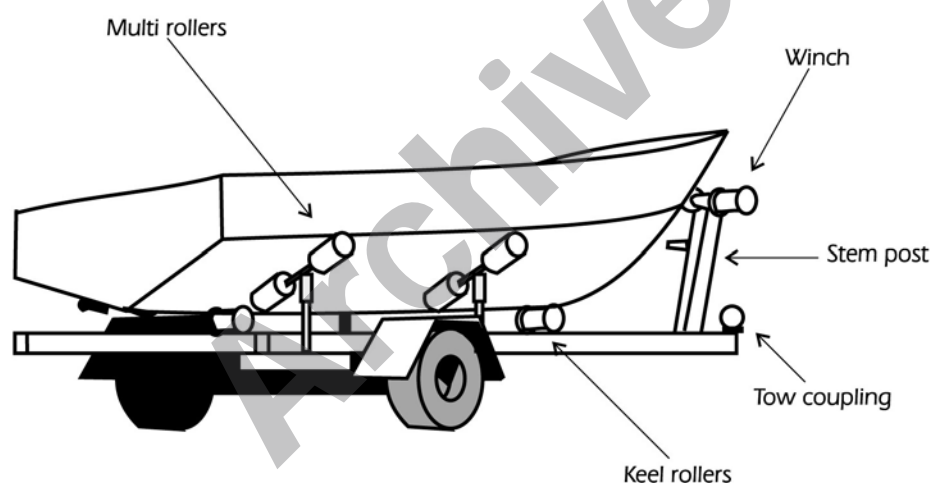

Figure 2:23

Trailer adjustment

Did you know?

The downward weight on the tow bar should be about 10% of the trailer mass up to the downward weight rating on the tow bar compliance plate. For example, if the boat and trailer weigh 600 kg, then about 60 kg of weight on the tow bar is good, as long as it does not exceed the tow bar's downward rating.

2.6 Periodic maintenance

The major causes of the breakdown of FRBs are electrical failures, fuel shortage or contamination, mechanical failure and battery failure. It is important to regularly inspect and maintain FRBs to reduce the likelihood of breakdown. Use the periodical maintenance checklist (below) at least monthly.

ITEM	CHECK	ACTION	
Logbook	List of defects	Fix any outstanding jobs/tasks.	
Hull	Cleanliness	Remove anything that may cause corrosion (aluminium boats). Stow all gear. Remove unnecessary equipment. Wash if needed, drain bilges.	
	Dents, gouges, corrosion	Repair or paint minor damage. Report serious damage.	
	Fixtures and fittings (seats, bollards, cleats)	Inspect, tighten or have repaired as necessary.	
	Winch cable/safety chain attachment point	Check safety chain is fitted. Check for damage and excessive wear to attachment point, shackles and cable/strap.	
	Bungs/self-draining scuppers	Check bungs are there, including spare. Check bung seals are in good condition. Check bung/scupper holes are clear.	
	Safety equipment	Check the PFDs are serviceable. Check the bucket/bailer with lanyard is stowed. Check the oars and rowlocks/paddles are stowed. Check that navigation lights work. Check that tools and spare parts kit are complete.	
Motor	Cleanliness	Wash and degrease if necessary.	
	Spark plugs	Remove and clean. Replace if damaged.	
	Wiring and leads	Inspect for: <ul style="list-style-type: none"> • damage • corroded joiners and terminals • loose or disconnected wires (eg main power to starter motor and earth cable on engine block). 	
	Fuel filter	Clean or replace if necessary.	
	Power head	Spray with anti-corrosive recommended by manufacturer.	

ITEM	CHECK	ACTION	
	Trim and steer pivot points	Inspect gearbox oil for water contamination (milky-looking oil). Inspect oil level; add oil if needed. Check for excessive drive shaft movement.	
	Gearbox	Inspect for damage: <ul style="list-style-type: none"> • remove propeller • grease drive shaft • file rough edges if necessary • refit propeller and check for tightness. 	
	Propeller	File away any minor burring. Knock out minor dents (take propeller off the motor first). Replace if large dents or serious damage found (send damaged propeller for professional repair and balance). Check the propeller nut split pin or retaining washer. Check spare propeller. Check the propeller shaft is well greased.	
	Anodes	Check they are fitted and secure. Replace if eaten away in excess of 50–60%.	
	Mounting bolts	Inspect for security.	
Trailer	Tow coupling	Inspect for security. Grease brake override shaft. Check coupling handle latch and safety clip. Check brake override latch is fitted and working. Check the handbrake works.	
	Safety chains and shackles	Check they are fitted and working.	
	Frame and chassis	Inspect for: <ul style="list-style-type: none"> • rust • cracks • damage. Clean if necessary.	

ITEM	CHECK	ACTION	
	Wheels and tyres	Check wheel nuts. Check tyre pressure. Check tyre wear.	
	Bearings	Jack and spin wheel. Listen for excessive noise and roughness. Wobble wheel and check for excessive movement or over-tightness. Report any problems. Grease bearing buddies if fitted.	
	Springs	Check for: <ul style="list-style-type: none"> • broken leaves • rust • pin wear—grease pins if grease nipples are fitted. Derust and spray with anti-corrosive.	
	Wiring and lights	Check the lights work. Check the wiring is in good order.	
	Brakes	Check for correct adjustment. Check brake pad wear. Check discs or drums for excessive corrosion and wear.	
	Rollers	Check: <ul style="list-style-type: none"> • damage • security • movement • adjustment. Remove, clean, grease and adjust if necessary.	
	Winch	Check winch operates correctly. Inspect rope/strap for damage.	
	Tie-downs	Check tie-downs are secure and working.	

ITEM	CHECK	ACTION	
Motor controls	Steering	<p>Check steering operates freely.</p> <p>Check engine achieves full-lock in each direction.</p> <p>Grease cable systems where required.</p> <p>Top up hydraulic oil if fitted.</p> <p>Bleed hydraulic system of air if required (see owner's manual).</p> <p>Adjust motor linkages if required (twin motor installation).</p>	
	Throttle/gear selector	<p>Check throttle/gear selector operates freely.</p> <p>Check engagement of forward/neutral/reverse gears.</p> <p>Check neutral throttle-up operates freely.</p>	
	Power trim (if fitted)	Check it works.	
Fuel system	Fuel lines	<p>Check connectors for leaks and damage.</p> <p>Check fuel line and fuel bulb for cracks and damage.</p> <p>Check fuel tank for damage.</p> <p>Check water separator/filter (if fitted)—replace if necessary.</p> <p>Check the arrow on the priming bulb is pointing towards the motor.</p>	
	Fuel	Replace old fuel (if more than three months old).	
	Oil	<p>Check oil reservoir (oil-injected systems)—top up if necessary.</p> <p>Check oil dipstick level on four-stroke motor.</p> <p>Ensure oil and filter are changed as per owner's manual (four-stroke).</p> <p>Ensure spare oil is available.</p>	
Electrical system (if fitted)	Battery	<p>Check electrolyte levels.</p> <p>Top up if necessary.</p> <p>Check terminals for tightness/cleanliness.</p> <p>Check battery tie-downs are secure.</p> <p>Check cables for damage.</p> <p>Check battery switch works.</p>	

ITEM	CHECK	ACTION	
	Cables, connections and fuses	Check they are in good order. Clean, repair, replace if needed.	
	Navigation lights	Test that they work. Replace globes/repair if needed.	
Starting	Engine runs	Start and flush the motor. Ensure telltale flows. Ensure engine runs smoothly. If cranking is slow, charge battery.	
Equipment	Compulsory safety equipment	Check: <ul style="list-style-type: none"> • anchor, chain and line (check shackles are moused with wire or cable tie) • bailing bucket and lanyard • fire extinguisher • first aid kit • navigation lights for night operations • oars/paddles • PFDs (Type 1) • radio • tools and spare parts kit (including spare pull-start rope) • torch. 	
	Recommended safety equipment	Check: <ul style="list-style-type: none"> • blankets • blunt-ended knife • boat hook • compass and/or global positioning system (GPS) • flares or electronic position indicating radio beacons (EPIRBs) • map/chart • mooring lines • signalling mirror • small bolt cutters • throw bag • tow bridle • 'V' sheet • water. 	

2.7 Safety equipment

The safety equipment carried on FRBs is required for crew safety. Much of it is required by law and must be carried at all times.

Keep safety equipment in good order and store it where it will not get wet or be in the way, but can be accessed quickly.

2.7.1 Compulsory safety equipment

Compulsory safety equipment must comply with the minimum requirements of State/Territory legislation. Items of compulsory safety equipment are:

- anchor, chain and line
- bailing bucket and lanyard
- fire extinguisher
- first aid kit
- navigation lights (for night operations)
- oars or paddles
- PFDs (Type 1)
- radio
- spare parts kit
- tools
- torch.

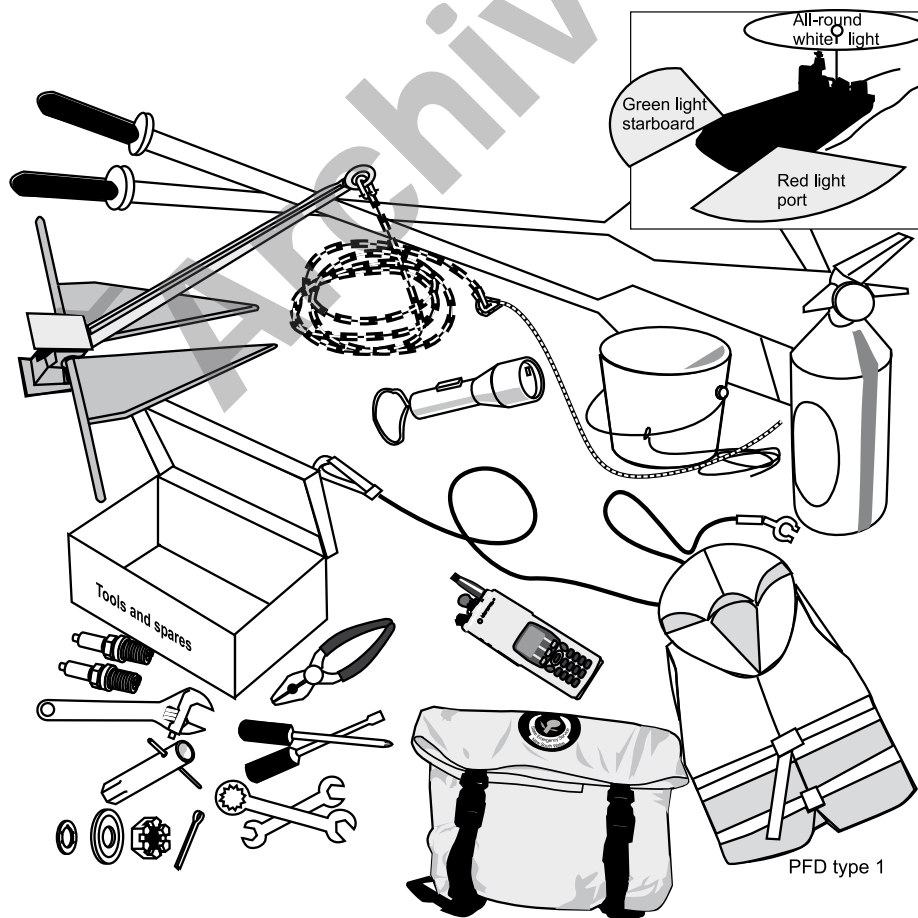

Figure 2:24

Compulsory safety equipment

2.7.2 Recommended safety equipment

FRB crew members should check their State/Territory SOPs for recommended safety equipment, which can include:

- blankets
- blunt-ended knife
- boat hook
- bolt cutters
- compass and/or GPS
- flares or EPIRBs
- maps and charts
- mooring lines
- signalling mirror
- small bolt cutters
- throw bag/rope
- tow bridle
- 'V' sheet
- water.

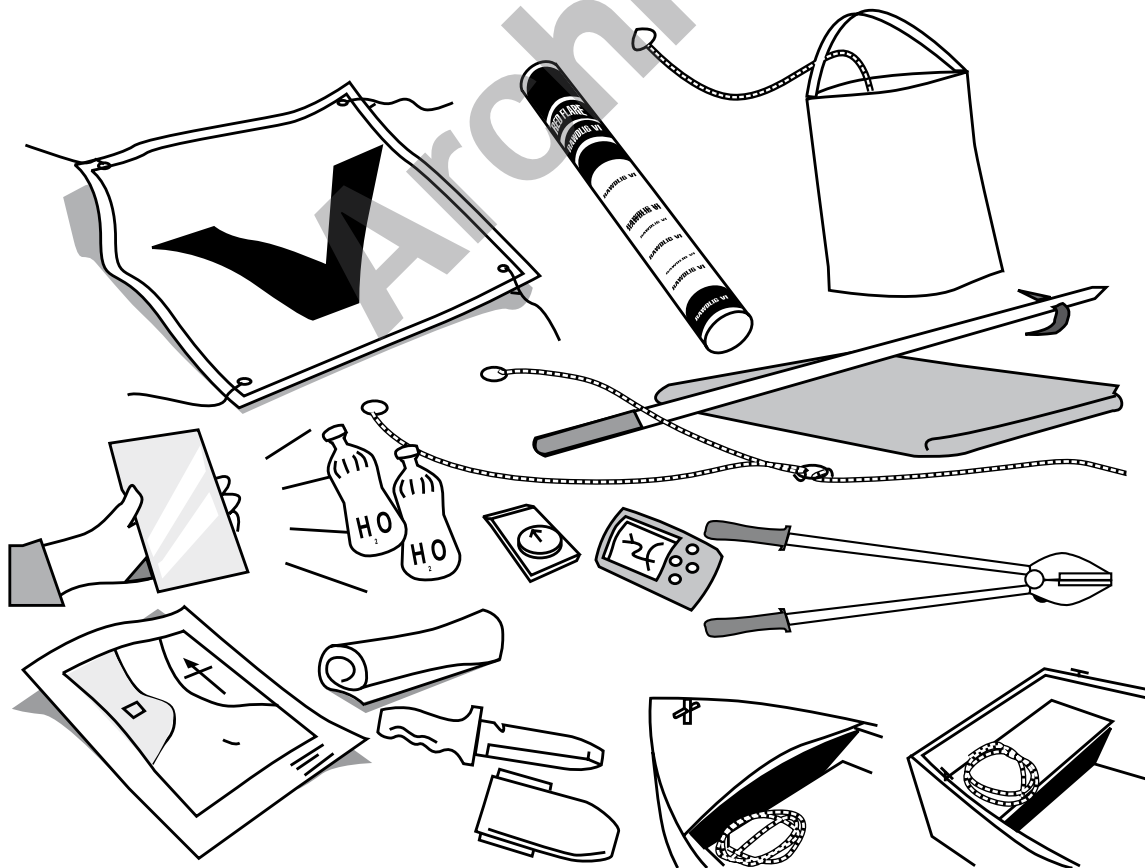

Figure 2:25
Recommended safety equipment

2.7.3 Equipment for special jobs

Depending on the nature of an operation, special equipment can include:

- basket stretcher
- body recovery kit
- shade cloth
- tarpaulin
- towing bridle.

Do not overload the FRB. Carry the necessary equipment for the task required.

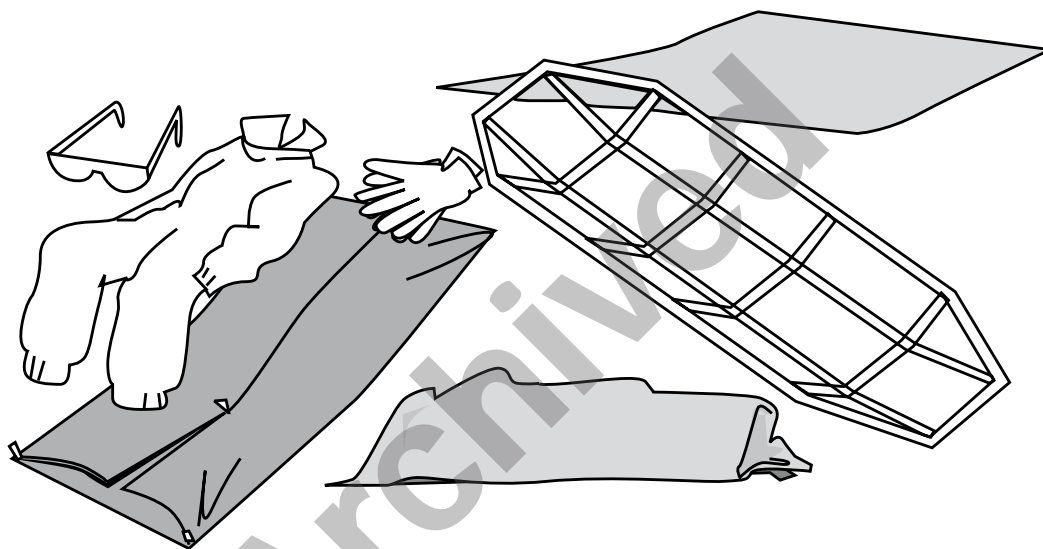

Figure 2:26

Equipment for special jobs

End of chapter. This page left intentionally blank.

Archived

3.1 Risk management process

FRB operations often involve FRB crews operating in hazardous environments and situations. Severe injuries and death have been directly caused by people working in hazardous conditions during or following floods.

A risk management approach to FRB operations ensures that:

- hazards are identified
- associated risks are assessed
- appropriate strategies are put in place to eliminate or control the risks.

The Australian Standard 4360 for risk management emphasises the need for constant monitoring, reviewing, communicating and consulting with respect to the hazards and risks identified.

3.2 Personnel

Crews have a responsibility to ensure that safety precautions are taken to prevent any injury to themselves or others. They should:

- know their own competencies and limitations
- ensure the person in command is informed of any problems that may exist with respect to an individual's health, competence and known limitations
- obey all organisational operation procedures
- understand and use safe work practices
- be physically and mentally prepared
- be aware of time pressures to complete operational requirements
- be aware of the consequences of being fatigued
- ensure compliance with organisational standards with respect to blood alcohol levels and drug usage.

3.3 Hazard identification

A hazard is anything with the potential to cause harm.

The identification of hazards often takes place during a reconnaissance of the work site.

A FRB operation requires as much care and assessment as any other potentially dangerous rescue operation. Although the types of hazards may differ from operation to operation, the assessment method remains the same. Some hazards are not readily recognised by simply looking around, so FRB crew members should employ proper questioning techniques.

They should also make full use of their senses:

- **sight**—look at the entire site and its surrounds for visual signs of danger
- **sound**—listen for any signs of danger (eg gas leaking, electric wires shorting out)
- **smell**—be aware of any odours that may indicate a source of danger (eg smoke, gas, fuel)
- **touch**—feel surfaces for signs of danger (eg heat, unstable structure, slippery surface).

Potential hazards are not usually confined to one particular area. They are normally spread out over the damage site and its surrounds. Ensure that all hazards are identified by undertaking a logical, progressive survey covering the whole site.

3.4 Common hazards

Common hazards in flooded waterways are:

- debris (trees, dead animals, building materials)
- powerlines
- muddy water
- bridges
- sewage
- currents
- waves.

Common hazards in flooded land areas are:

- fences
- sewerage
- overhead lines
- animals
- submerged buildings
- vehicles
- trees
- uncharted and changing depths.

Other flood hazards covered in more depth later in this manual include strainers, bridges, river waves, water curl back, eddies, hydraulics, holes/stoppers, whirlpools, rapids and weirs.

3.4.1 Weather conditions

Wind, rain, hail and lightning are obvious weather conditions that pose a hazard to crew members when operating FRBs. Crew members need to consider each hazard individually and undertake a risk assessment prior to determining if it is safe to proceed.

Other weather conditions that should be considered include extremes of temperature and the effects of the sun, which may result in dehydration and sunburn. These can have a direct bearing on crew member safety.

To avoid the effects of adverse weather conditions, it is important that FRB crews:

- enforce safety precautions and appropriate dress standards
- ensure the provision of adequate rest breaks, food and drinks.

Archived

3.4.2 Working at night

Working at night can increase the dangers involved with FRB operations. Crew members should take care when using lights at night, especially when working on floodwaters. The incorrect positioning or use of lights, even a torch, can affect night vision and cause accidents.

Care is also needed when moving from a lighted area into a darker, unlit area. Crew members should allow time for their eyes to adjust to the darker conditions before continuing with the task.

There are advantages and disadvantages to using spotlights. Crews need to consider each situation and their own personal preferences when deciding on the use of lights. Navigation lights should be fitted to all FRBs and used in accordance with State/Territory regulations.

3.5 Public utilities

3.5.1 Electricity

One of the most common hazards associated with flooding results from inundated powerlines, especially where the lines are close to or over the floodwaters. Take care with the movement of boats when operating under or around these lines.

Particular hazards to be aware of include:

- communication cables, which carry vision and telephone networks, can carry up to 90 volts (eg some cable television lines)
- optic fibres, which can cause damage to eye sight, so always avoid looking into the ends of these cables
- television antennas and satellite dishes, which can carry 24 volts but, if badly damaged (eg by dampness on cables), can become active to 240 volts
- a building's internal power supply, which can become a hazard if the wiring has been damaged or the circuit has suffered water penetration or been damaged by lightning strike.

In major floods where streets and houses are submerged, the power authority must turn the power off. FRB crews must wait until the power authority declares an area safe before they can go in.

3.5.2 Safe working clearance

The area surrounding big, high voltage lines is considered unsafe and is called a **safe working clearance**. A person who goes inside the safe working clearance could be electrocuted and killed. FRB crew members working near these lines must ensure they are outside the safe working clearance for the voltage concerned. If they have to cross under these lines, they must ensure the lines are de-energised and isolated by the relevant power company.

Safe working clearances are:

- 3 metres up to 132 kV
- 6 metres up to 330 kV
- 8 metres over 330 kV.

WARNING

Crews must maintain a safe working clearance of at least three metres at all times unless they have been trained to identify voltages and understand safe working clearances, or have been given approval from the network owner who owns the powerline.

When in doubt, ask the liaison officer from the power network for advice – you might have to take someone out on the first run for reconnaissance.

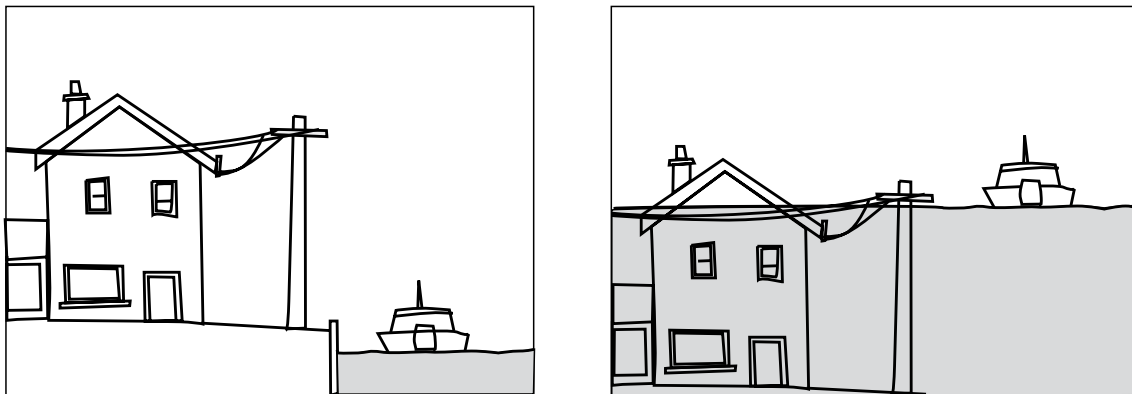

Figure 3:1

Power: Before flood

During flood

3.5.3 Powerlines

In many flood situations powerlines may be damaged and under water, making them difficult to locate.

Powerlines are particularly dangerous in rural areas, where the length spans can be 160 m or greater, resulting in a conductor sag ranging from 2.5–3.5 m. The pole tops may be visible but the depth of the conductors under the water will be unknown.

On high voltage lines there may even be an earth conductor at the top of the pole, which may be dangerous even when the live line is de-energised.

Never assume powerlines or electrical apparatus are de-energised in flood or storm conditions. Always check that the network owner has proven them dead.

FRB crews should avoid powerlines where possible, or take a power company expert with them for advice.

Wooden powerlines

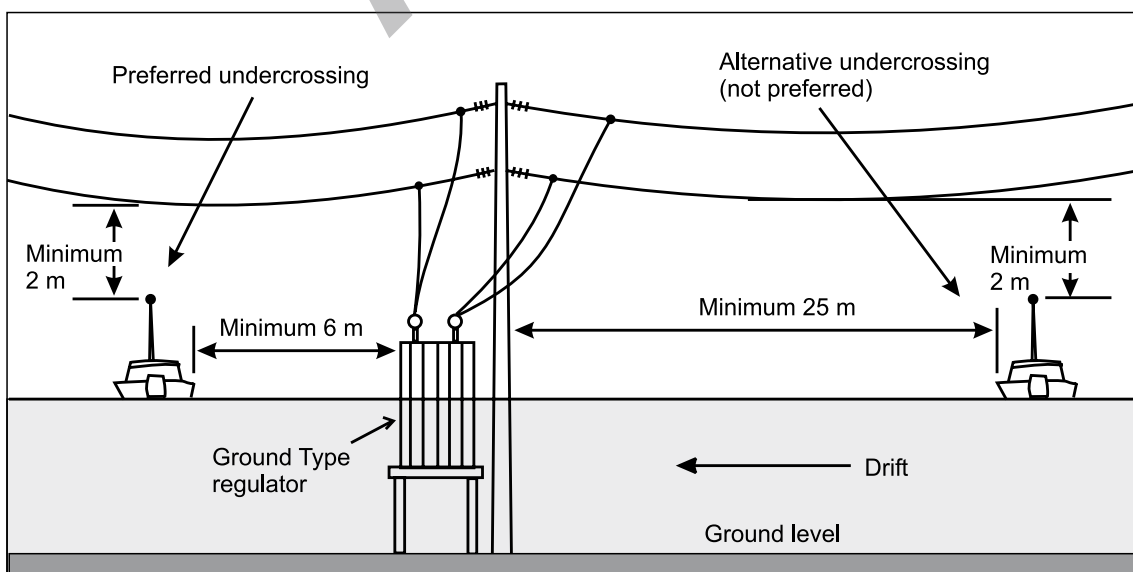

Figure 3:2

Undercrossing near ground structures—wooden pole lines

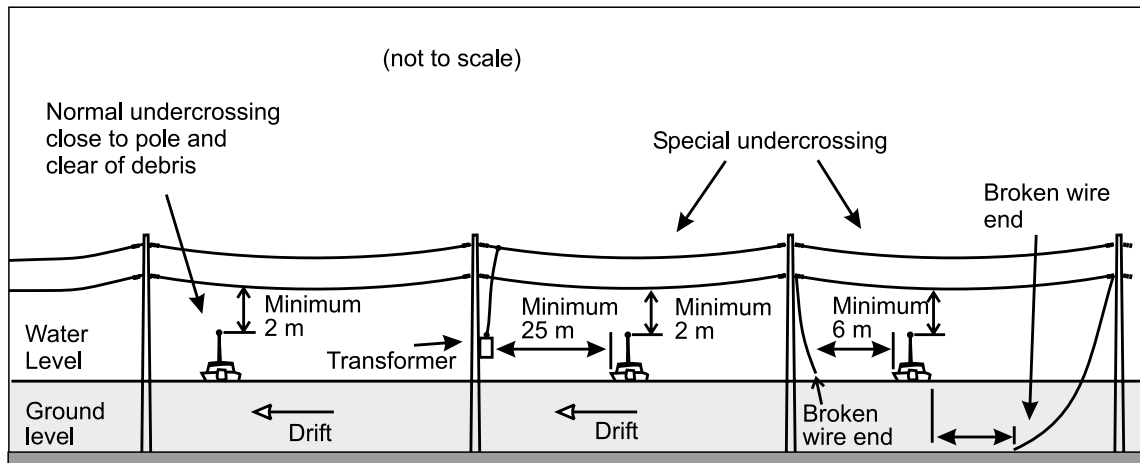

Figure 3:3
Undercrossing wooden pole lines

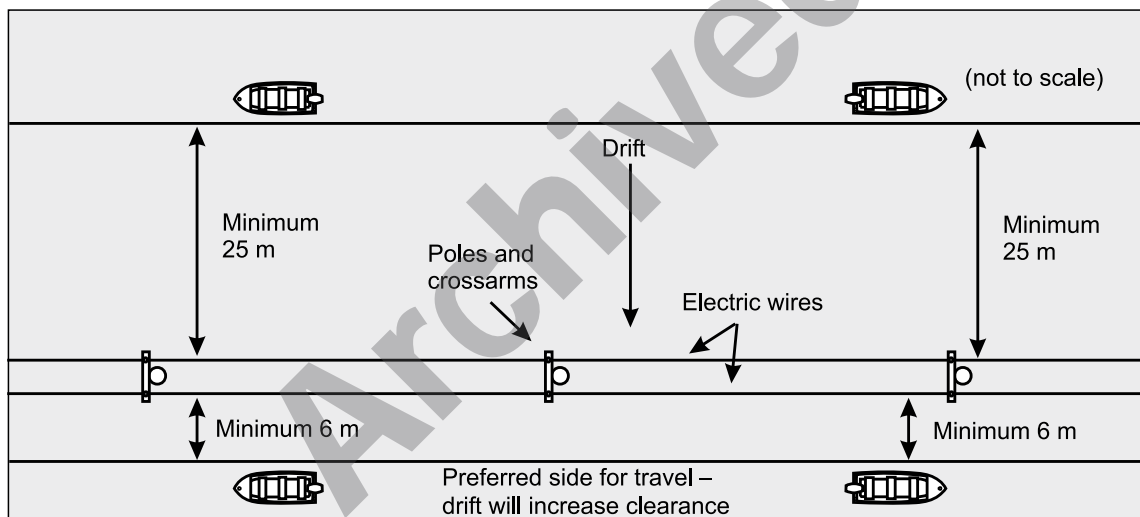

Figure 3:4
Travel alongside a wooden power pole line where there is lateral drift

Position the boat so the current takes the FRB away from danger if the motor fails (eg stay on the downstream side of powerlines if possible).

Steel tower lines

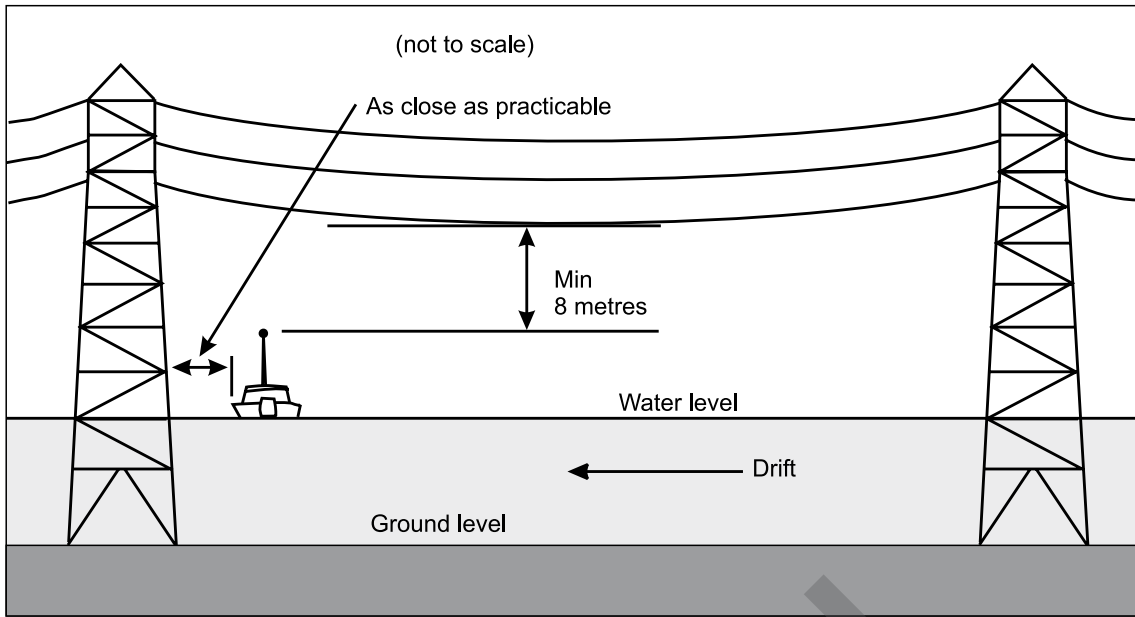

Figure 3:5
Undercrossing steel powerlines

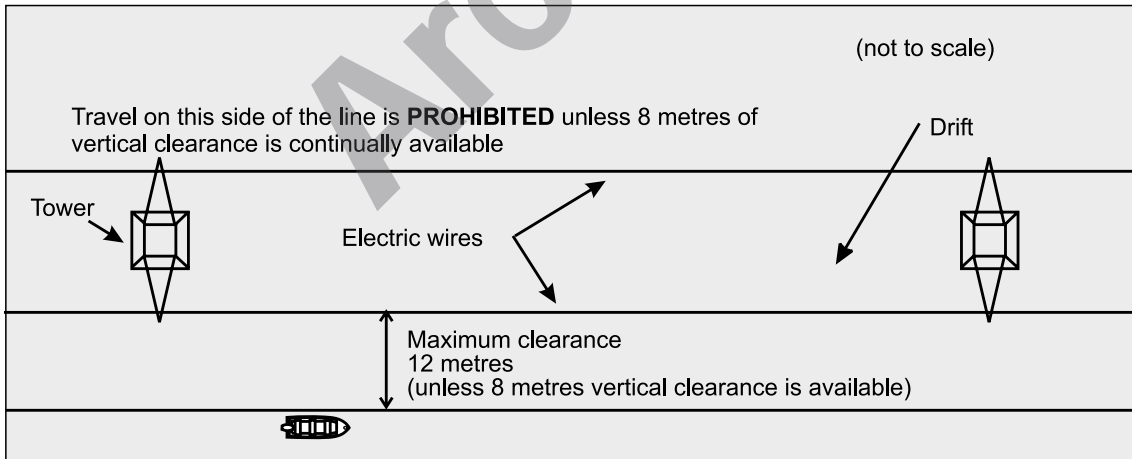

Figure 3:6
Travel alongside a steel tower line where there is lateral drift

3.5.4 Sewerage

Sewerage utilities may be damaged, causing risk to health. Contact relevant authorities where there is damage to sewerage systems.

3.6 Trees and branches

Trees, especially shallow-rooted trees, can be a hazard. Trees and branches can be weakened by storm and water damage and may only require minimal disturbance to fall.

Fallen trees can also pose a problem when they become uprooted and drift with the floodwaters.

3.7 Debris

The presence of flood debris is a potential hazard. Working among debris can be unsafe. Implement appropriate control measures to minimise the risk.

3.7.1 Chemicals

Floods often pick up chemical containers or drums from factories and farms. Do not go near them, as the chemicals inside can be dangerous and the drums may be leaking. Some chemicals can react with others and explode, burn or make poisonous gas.

Report any hazardous material to the State/Territory hazardous materials agency.

3.8 Fauna

Animals and insects may create risks during storm and water damage operations. Again, like all other hazards, undertake a full risk assessment and put appropriate controls in place prior to commencing the task.

3.9 Contamination and disease

Take care when working around hazardous materials such as chemicals and waste. Hazards such as stagnant water and sewerage have the potential to adversely affect the health and wellbeing of crew members.

3.10 Equipment and vehicles

Always use equipment for FRB operations safely in accordance with organisational policy and procedures.

Observe all road rules and organisational policy when driving a vehicle in response to a FRB operation. Excessive speed or failure to observe traffic regulations are not warranted in these situations. Road conditions are normally poor following storms and floods, so use caution when operating vehicles in these situations.

Take care when parking a vehicle on-site to ensure the vehicle is visible to other road users. At night and in poor visibility, ensure hazard warning systems are displayed as appropriate.

Allow a sufficient safe working area around the vehicle and boat for the unloading and loading of equipment and crew members.

Ensure that all items of equipment are secured to the vehicle and boat before moving off. This includes securing equipment carried inside the vehicle to prevent injuries due to unexpected movement.

3.11 Main FRB safety considerations

The main considerations for the safe operation of FRBs are listed below:

3.11.1 The weather

Weather information, conditions and forecasts—including expected rainfall, flood peaks, winds and temperatures—are critical before making a decision to commence an operation.

Helpful information to plan a FRB operation includes:

- wind direction and speed
- tide times/predicted flood heights
- wave height/current speed
- times of daylight/nightfall.

Did you know?

The Bureau of Meteorology issues forecasts several times each day and updates these regularly. The Bureau also issues special weather warnings as required (eg wind, storm and flood warnings). These are available at www.bom.gov.au and are broadcast frequently on radio, television and coastal stations. They are also available by telephone and fax from the bureau.

3.11.2 Safety before and during an operation

Before undertaking a FRB operation, crew members should:

- check the seaworthiness of the FRB, motor and equipment
- ensure that the FRB is suitable for the task to be performed
- familiarise themselves with the FRB and its equipment
- know the limitations of the FRB, equipment and other crew members
- obtain all possible information about the area of operation
- always check fuel before leaving shore, and carry sufficient for the task plus a reserve
- be aware of the amount of fuel consumed by the boat's motor under operating conditions.

Tip: crew members should use the $\frac{1}{4}$ rule when checking fuel (ie $\frac{1}{4}$ to get there, $\frac{1}{4}$ to do the job, $\frac{1}{4}$ to return and $\frac{1}{4}$ in reserve).

During a FRB operation, crew members should:

- be conscious of the load being carried, its weight and distribution
- ensure there is sufficient freeboard for the prevailing conditions
- distribute the load evenly to ensure good trim
- restrain any load to avoid movement
- keep the centre of gravity low
- ensure occupants sit on the seats provided or on the floor. They must not sit on the gunwales or on the foredeck. Hands must not be placed on the gunwales or outside the boat, as they may be crushed or injured.

The coxswain must:

- obey all speed limits—where no speed limits apply, ensure speed is related to the conditions
- avoid high-speed turns or violent manoeuvres
- when approaching any landing, reduce speed to allow a gentle, controlled docking
- where possible avoid reversing in shallow water. The propeller on a reversing motor is at its greatest risk of striking a submerged obstruction, which may cause serious damage to the propeller or the motor.

3.11.3 The stop and take 5 rule

When assessing risk and considering the safe operation of FRBs, crew members should use the **stop and take 5** rule (see section 5.4.1 for more details).

- 1 Stop, stand back and observe.
- 2 Think through the task.
- 3 Identify hazards.
- 4 Assess and control risks.
- 5 Continually monitor risks.

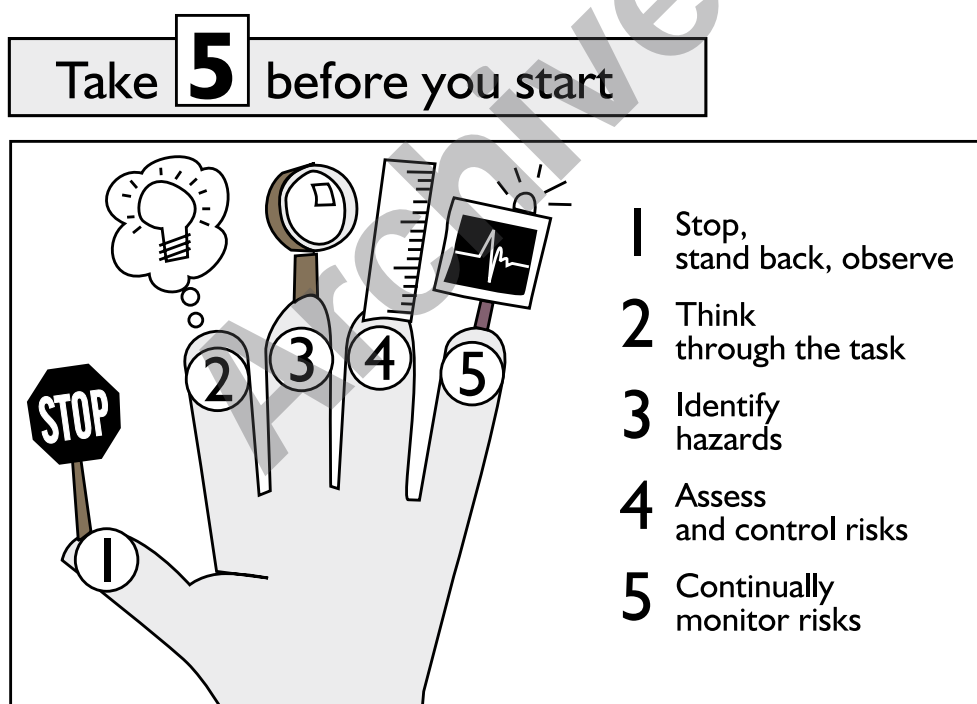

Figure 3:7
Stop and take 5

3.12 Controlling risks

Once the hazard identification and risk assessment has been done, it will probably be necessary to take action to ensure that the risks are eliminated or controlled so that they do not endanger emergency workers or personnel or the public. This action normally fits into one of the categories in the hierarchy of control.



Figure 3:8
Hierarchy of control

- a. **Design**—this is the most effective treatment option and involves selecting appropriately designed equipment or work processes to eliminate the hazard.
- b. **Elimination**—this is a solution that should remove the hazard altogether. This could involve clearing debris from the site, removal of fuel, arranging for disconnection of electricity supply, and so on.
- c. **Substitution**—the process of replacing the hazard with one that represents a lower risk is called substitution. An example may be the use of a more experienced team to replace a less experienced one.
- d. **Redesign**—redesigning or modifying plant or work processes involves a structural change to an existing piece of equipment or process in order to place an engineered barrier between the individual and a hazard or to interrupt the transmission path of a hazard. An example might be the use of a roof-top safety system.
- e. **Separation**—separating or isolating the hazard involves enclosing the hazard or increasing the distance between the individual and the hazard, such as by roping-off or barricading unsafe areas (eg a building, which could possibly collapse, or downed powerlines).
- f. **Administration**—administrative controls attempt to reduce or eliminate exposure to a hazard by introducing the need to follow workplace procedures or instructions. Examples are SOPs, appropriate training, hazard warning signs and safe work practices.
- g. **Personal protective equipment (PPE)**—PPE is worn by individuals as a last line of defence against a risk and should only be used in conjunction with a higher option. The appropriateness and effectiveness of the PPE must be considered at all times. Examples include head protection, gloves, boat shoes and so on.

The person in command is accountable for hazard identification and should make any arrangements to eliminate or reduce the risk by use of appropriate controls.

3.13 Summary of risk management

Risk management is more than just looking around for obvious dangers. It involves using all the senses and questioning techniques to identify all potential hazards.

A properly conducted risk management process can prevent serious injury or even death, and should be carried out at each individual site regardless of location or urgency.

The safety of team personnel and the public is far more important than the protection of property. Personnel should not allow property owners to pressure them into attempting to effect repairs if the hazards present warrant other action.

Risk management is for the safety of the team personnel and public on site. Notify the tasking headquarters of any delay in the completion of a task or inability to provide assistance because of unsafe conditions.

3.14 Safety responsibilities

Safety is the responsibility of all personnel at all levels. Take note of the following safety responsibilities:

- each person has a duty to draw attention to any matter relating to any aspect of safety
- each individual is required to act safely at all times and not, through their actions, endanger themselves, others or their environment
- organisational SOPs must be followed.

REMEMBER: SAFETY IS EVERYONE'S RESPONSIBILITY

The safety of team personnel and the public is far more important than the protection of property. At no time should unacceptable risks be taken. To ensure unacceptable risks are not undertaken, implement the risk management process at all times for the safety of all those involved in the operation.

End of chapter. This page left intentionally blank.

Archived

CHAPTER 4

Plan and Prepare for an Operation

4.1 The AOLR process

FRB crews should use the AOLR (Assess, Organise, Lead, Review) process to plan and prepare for an operation.

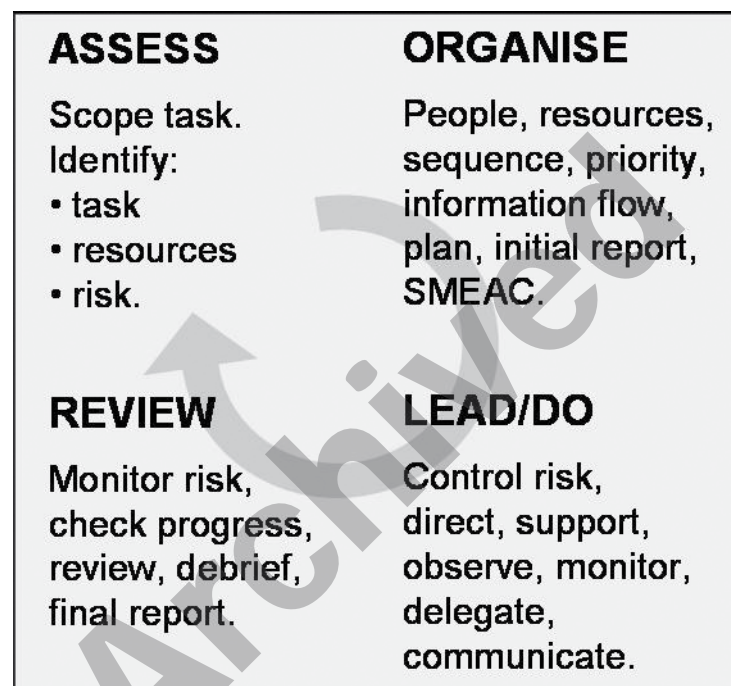

Figure 4:1
AOLR process

4.2 Assess

Crew leaders and crew members in command of a FRB are tasked with operations, often by operations staff with little or no FRB experience. They need to assess the operation and make the final decision on whether to go out on an operation. When deciding if an operation can be done, assess the:

- nature of the operation
- type of FRB available and the capabilities of crew members
- operation priority
- lay of the land (also look at a map)
- weather.

4.2.1 Make the decision

Operating boats during floods can be extremely dangerous. Water moves down rivers very quickly with great force, and can carry all sorts of debris including trees, cars and parts of houses. High winds can also cause dangerous conditions, especially on open water such as dams.

The person in command must consider if the operation is within the experience and ability of the crew, the FRB and him/herself. During the assessment the person in command must ask him/herself, 'Is this possible to do safely?' If the answer is 'no' or looks like it should be 'no' at the time the FRB is to be put in the water, then say 'no'.

REMEMBER

The people who task FRB crews with operations may not have enough information and experience to make this decision.

4.2.2 Local knowledge

FRBs are operated in two types of flooded areas:

- areas where they normally operate but with higher water levels, currents, debris and many new hazards
- in places that are normally travelled across in vehicles or by foot (eg roads, streets and paddocks). In some areas these places may be very large.

Be aware of the local issues in normal operating conditions (fill in the 'local details' column in the following table).

Issue	Local details
Access to the waterway	
Launch and recover sites	
Water depths	
Banks and sand bars	
Weirs, rapids and isolated dangers (eg a sunken barge)	
Navigation markers	
Bridge heights	
Submarine cables	
Ferries, dredges, commercial and private vessels	
Other	

Before flood

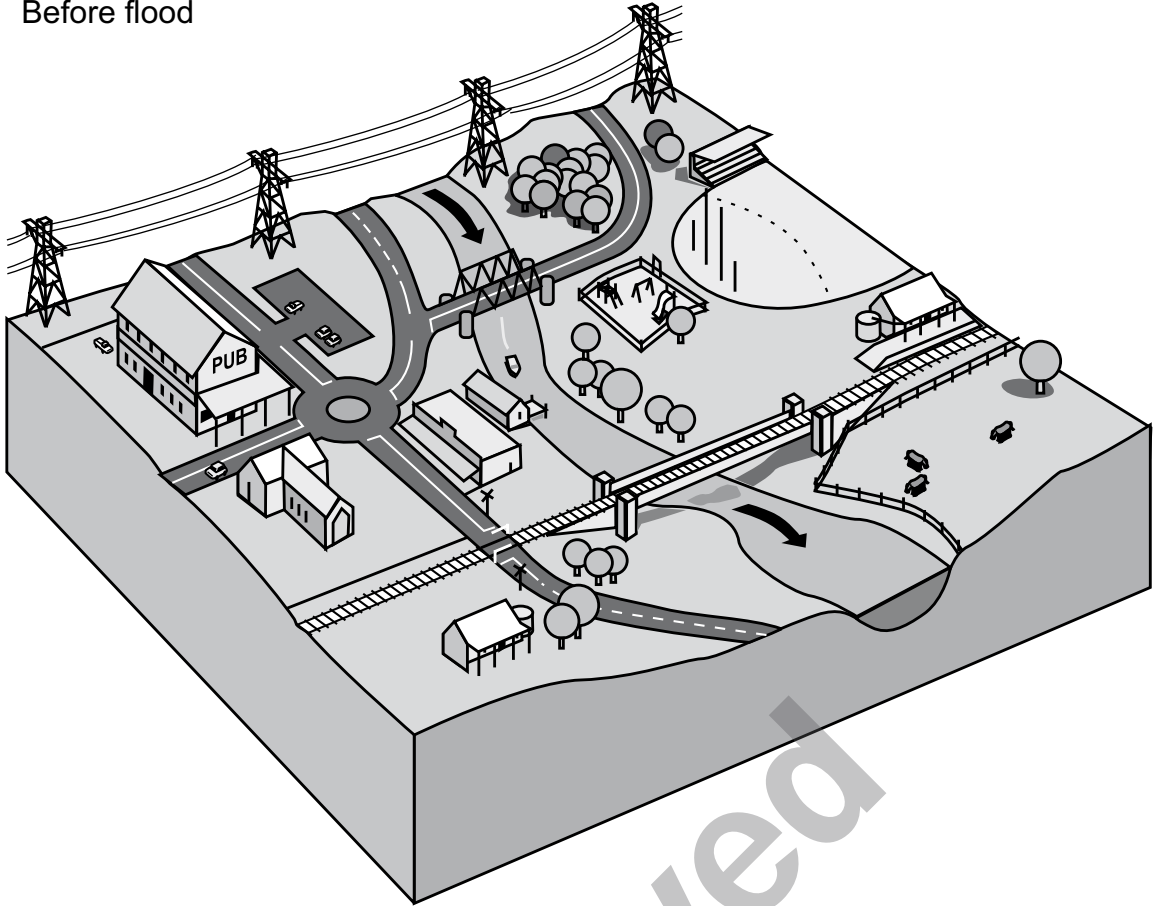

After flood

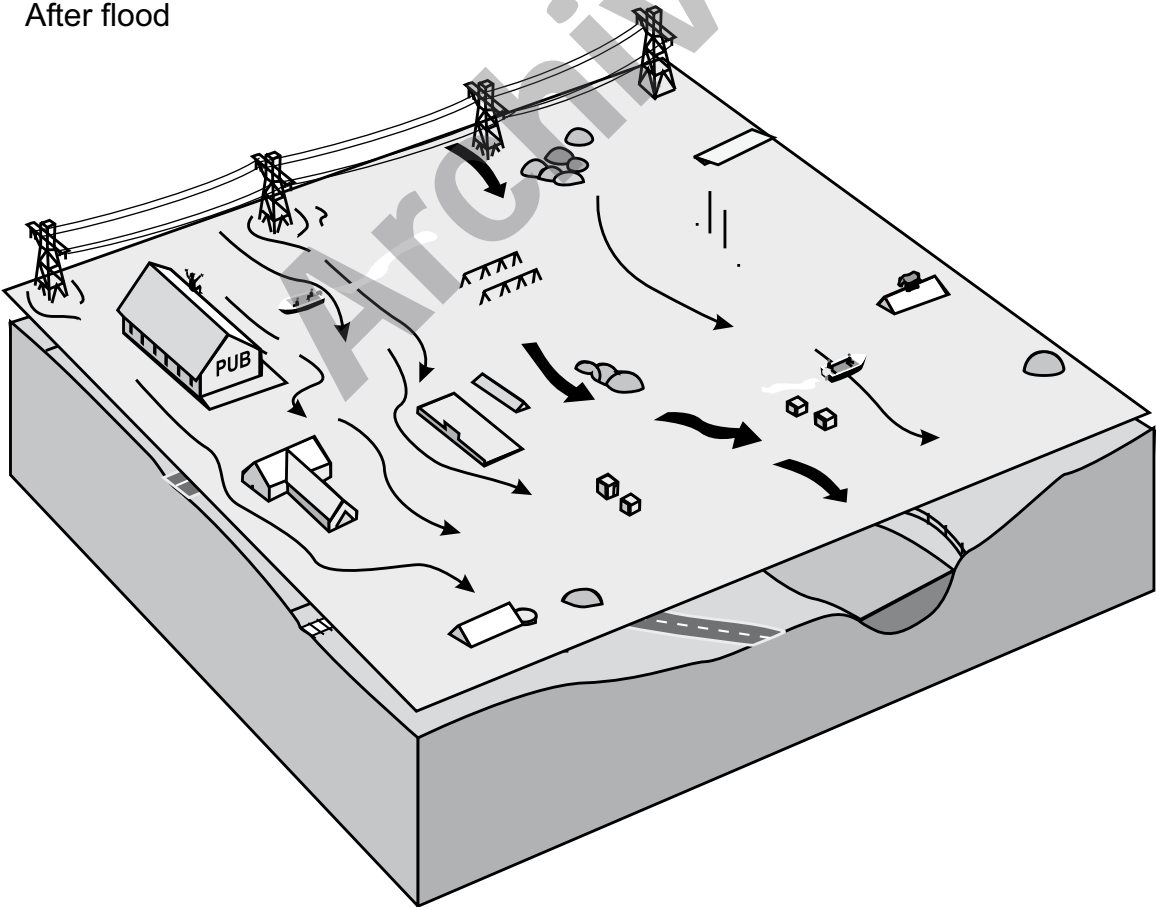



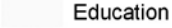







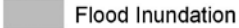





Figure 4:2
Local knowledge (before/after)

Inundation maps provide an idea of where FRBs may be needed and can be checked for hazards. Past flood experiences can also be helpful. In flood conditions things such as landmarks, navigation and reference points can change. Note any hazards or data that will help during an operation. This information can be found in local flood plans.

Legend

 SES	Roads	General Land Zones
 Aged Care Facilities	 Sub Arterial Road; Arterial Road	 Education
 Airport	 Local Road	 Parkland
 Caravan Camping	 Vehicular Track	 Residential
 Child Care Facilities	 Flood Inundation	
 Hospitals	 Rivers	
 Educational Facilities		

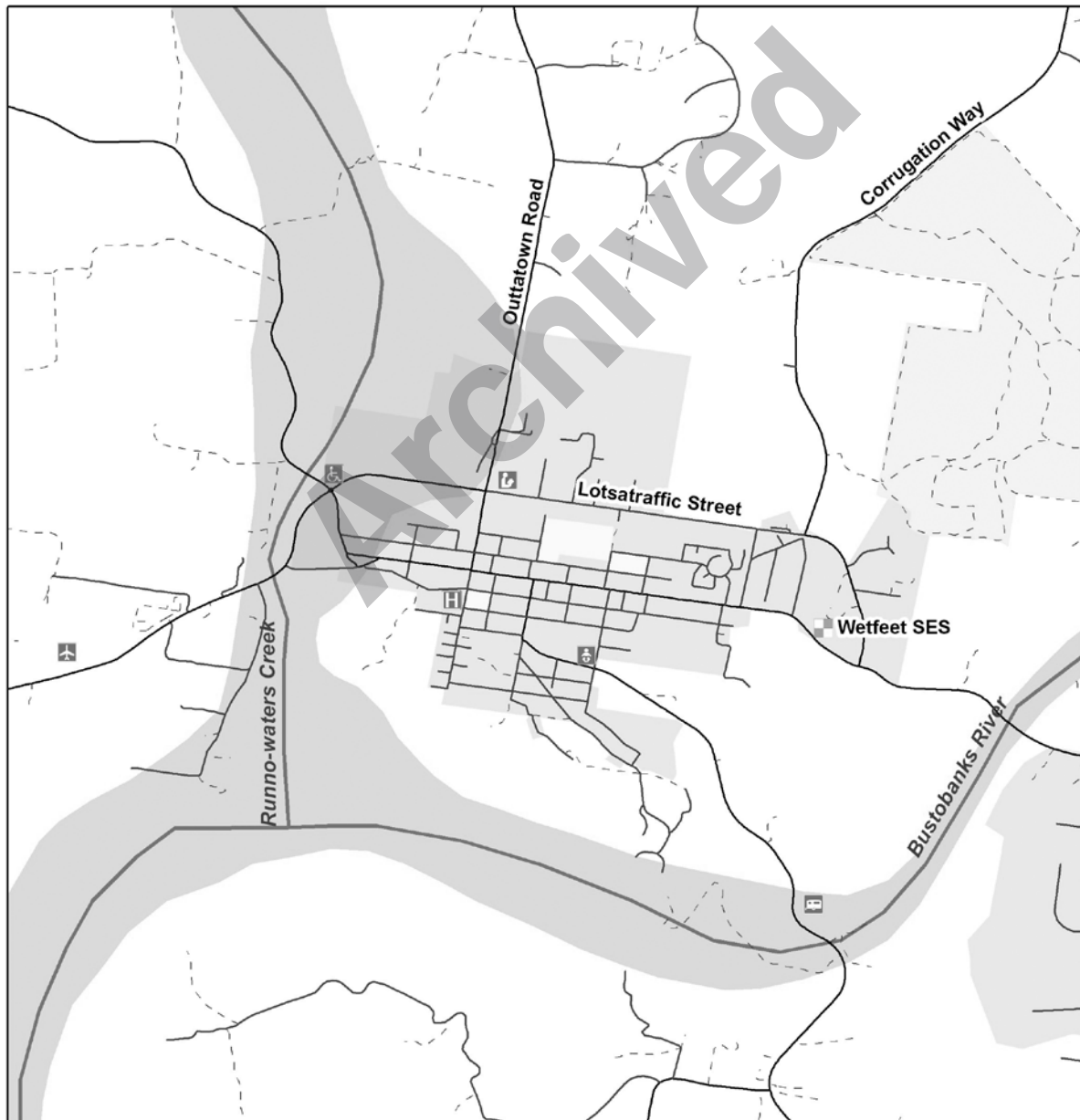

Figure 4:3
Inundation map

4.3 Organise

The crew leader or person in command should make a plan about how to do the operation, and organise any people and materials needed. Things to consider include:

- picking the right crew for the operation
- ensuring every crew member is dressed correctly (including PPE)
- organising supplies or equipment (eg stores or feed if doing a resupply or fodder drop)
- working out how long the operation will take
- doing the pre-departure checks
- reporting the crew's departure.

Complete the pre-departure checks before leaving the local unit (see section 5:1).

4.3.1 Report the departure

Before departing the boat ramp on an operation, the person in command must advise the local unit of the departure. The report should include:

- time of departure
- place of departure
- where the FRB is going
- the operation that is being done
- estimated time of return
- number of people on board.

4.3.2 SMEAC briefing

Once a plan has been worked out, the crew members must be given information. The best way to do this is by using a SMEAC briefing, which is a proven method of relaying instructions to a team.

S M E A C

SITUATION

What happened, what's the situation now.
Relevant intelligence, information and assumptions.

MISSION

A concise single sentence statement of the overall outcome.

EXECUTION

Who, what, when, where and how?

ADMINISTRATION AND LOGISTICS

Support – equipment, personnel, vehicles, accommodation, catering.

COMMAND, CONTROL, COMMUNICATION AND CONFIRM

Command structure, comms arrangements and confirm.

Figure 4:4
SMEAC

Consider the following when conducting a briefing:

- location
- lighting
- protection from the weather
- seating arrangements, and
- sequence.

4.4 Lead

To ensure a crew performs well, crew leaders or the person in command have to continually provide support, direction, focus and motivation, and lead by example.

Crew leaders or the person in command must supervise and monitor their crew and FRB to maintain safety and to carry out operations efficiently and effectively. They should take into account crew members' ideas about how to conduct an operation, but they are accountable for making final decisions.

They should also ensure they report to unit headquarters regularly on the progress of the task.

4.5 Review

The person in command must hold an after-action review at the end of an operation.

Note: debriefing is about improving personal and crew performance, not about blaming people.

4.5.1 The `www.debrief`

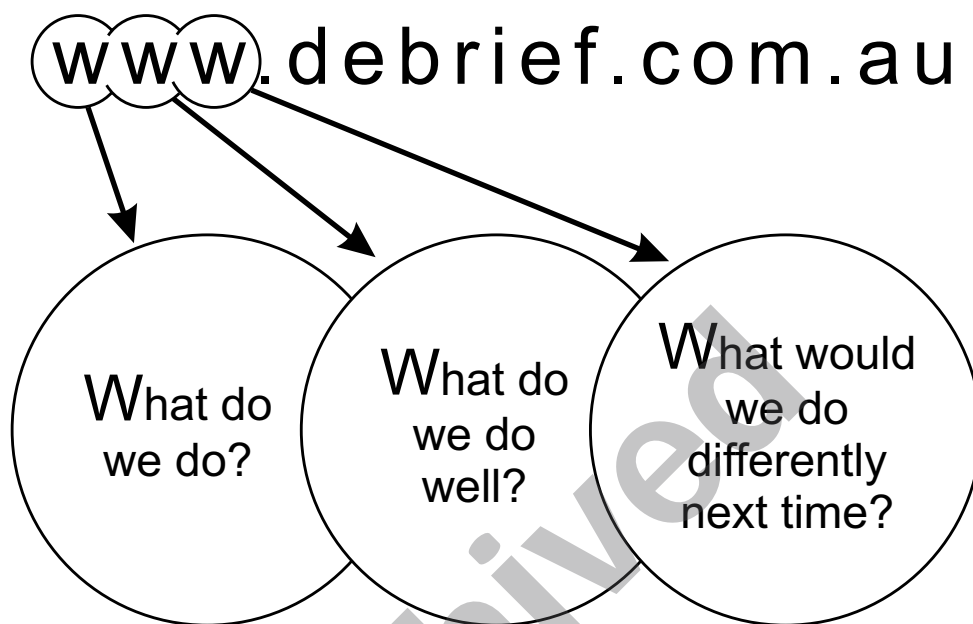

Figure 4:5
www.debrief

The `www.debrief` is a process that asks three questions:

- **What did we do?** This is extremely important and may have to be documented, especially if a body was recovered. These details need to be written and/or given to police. Follow the ‘who, what, where, when, why?’ formula to write down significant events. These details can also be radioed back to the unit headquarters to record in the operations log as they happen.
- **What did we do well?** This shows what worked well so that the same or similar techniques can be used next time.
- **What would we do differently next time?** Anything that went wrong or could have been done more efficiently should be discussed, and any learning point acted upon.

REMEMBER

Crew leaders or the person in command should make a call to the peer support number if they or their crew have been exposed to anything stressful or upsetting while carrying out the operation.

End of chapter. This page left intentionally blank.

Archived

CHAPTER 5

Tow, Launch and Recover

5.1 Pre-departure checks

FRB crew members should do a pre-departure check before leaving for an operation. Complete the following checklist before leaving the local unit.

PRE-DEPARTURE CHECKLIST			
ITEM	CHECK	ACTION	
Boat	Equipment	Check all equipment is stowed and/or tied down.	
	Safety equipment	Check safety equipment is stowed correctly.	
	Specialist job equipment	Assess the operation and take the appropriate equipment (eg body recovery kit and basket stretcher).	
	Tie-downs/safety chains	Check boat is tied down to trailer. Check safety chains are secure.	
	Bungs	Check bungs are carried.	
Motor	Ignition key and kill switch lanyard	Check the key and lanyard are on board and in a secure place.	
	Travel position	Ensure the motor is in the travel position (eg use motor support if fitted).	
	Power	Check that the battery is charged.	
Fuel/oil	Levels	Have enough fuel and oil for the operation.	
Trailer	Coupling	Check coupling is on tow bar, locked down fully, safety clip in place. Check safety chains are shackled to towbar.	
	Brakes	Check brake override latch is open if brakes are fitted. Check handbrake is off.	
	Lights	Connect lights and test.	
	Wheels	Check jockey wheel is stowed. Check spare wheel and wheel-changing kit is carried.	

5.2 Towing

The driver of the vehicle is responsible for checking the condition of the trailer and its load before towing. Before leaving the local unit, check:

- if the vehicle can legally tow the FRB
- if the tow bar is rated to tow the FRB
- the down load on the tow ball (it is recommended at 50–80 kg)
- the car owner's manual and registration papers and the tow bar's compliance plate.

Always follow traffic regulations when driving and towing trailers on the road. If possible, avoid carrying equipment in FRBs while towing. Anchors, fuel tanks and other bulky objects can wear holes in aluminium hulls through vibration and movement.

When towing a FRB long distances, stop every two hours and check:

- trailer coupling
- safety chains
- brake latch
- tie downs
- wheels and tyres (including bearings)
- security of equipment.

The trailer will cut corners, so it may be necessary to swing wide around turns.

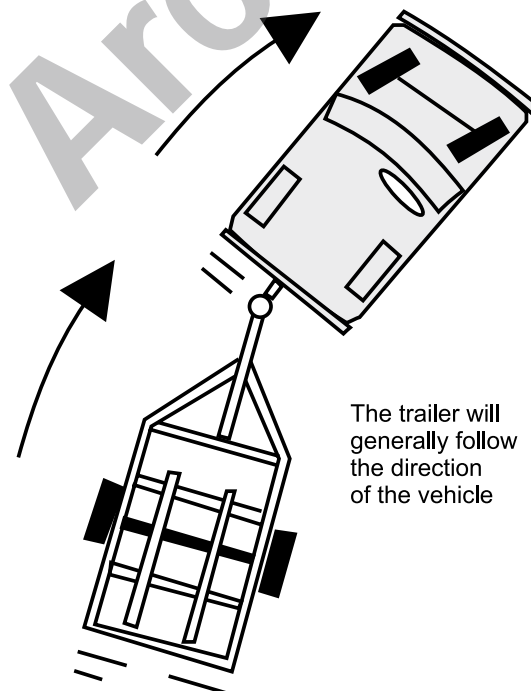

Figure 5:1
Pulling a trailer

5.2.1 Reversing

Before reversing, the driver should:

- stop and look around for hazards
- ensure the brake reversing latch is in the closed position; otherwise, the trailer brakes will come on when the weight of the boat and trailer are forced onto the towing vehicle
- ensure the outboard motor leg will not hit the ground
- use a guide if necessary
- ensure no one is between the trailer and tow vehicle or behind the boat.

Did you know?

Drivers can engage low-range four-wheel drive vehicles without locking the hubs. This lowers the reverse gear ratio, allowing the driver to drive very slowly without riding the clutch. The hubs do not need to be locked unless the launch site is slippery or boggy and more traction is needed. Locking the hubs on hard surfaces will cause drive train wind-up and may cause mechanical damage (check the vehicle owner's manual).

Tip: at night, a torch light shone on the trailer wheel/arch can assist the driver or guide.

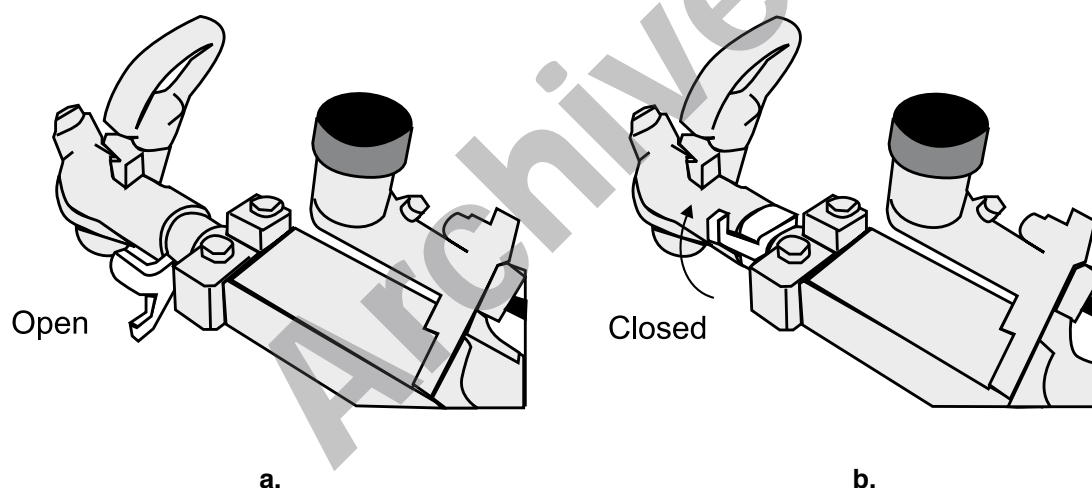

Figure 5:2
Brake latch

Figure 5:2 shows the brake latch, which:

- needs to be open when towing
- needs to be closed when reversing.

5.2.2 Reversing with a guide

A guide should use the following commands when guiding a reversing vehicle and trailer. The guide should be looking at the trailer and standing near the driver so the driver can hear the commands. When the guide is looking at the trailer, it will go in the direction of the command (eg left hand down means the trailer will go left).

COMMAND	DRIVER ACTION	RESULT
Left hand down	Driver turns wheel to his/her left.	The rear of the trailer will go left (as the guide looks at it).
Right hand down	Driver turns the wheel to his/her right.	The rear of the trailer will go right (as the guide looks at it).
Straighten up	Driver turns the wheel to straighten up the wheels	The vehicle will follow the trailer.

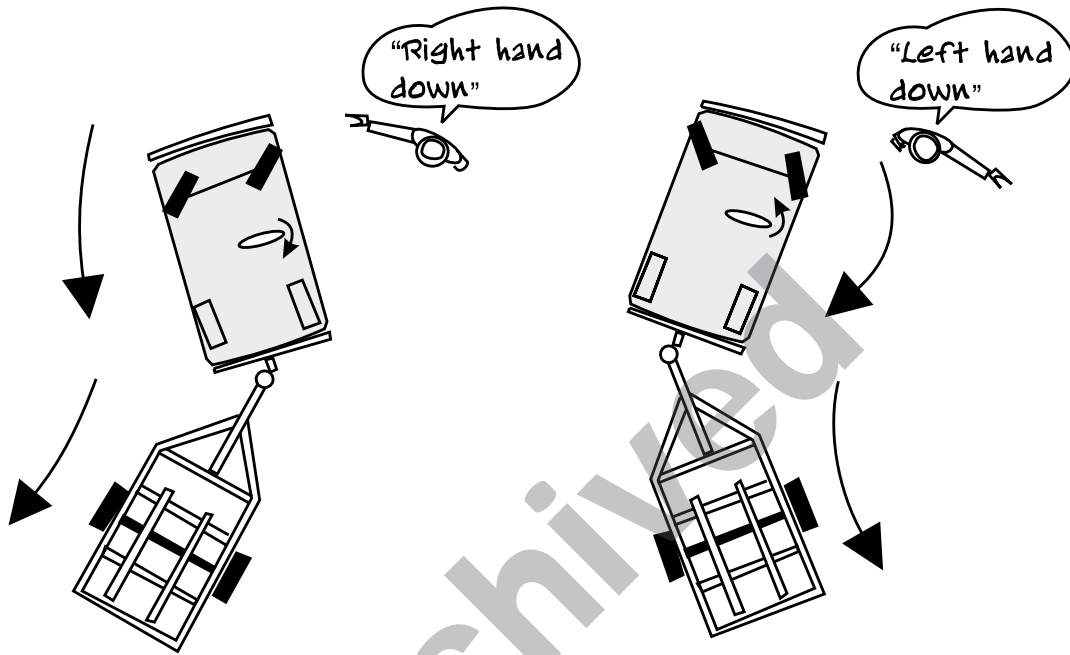

Figure 5:3
Reversing a trailer

5.2.3 Reversing using the mirrors

When reversing a trailer using the mirrors, use the following technique to help:

- if the trailer appears in either mirror, turn the steering wheel towards that mirror to straighten the trailer or to turn it the other way.

5.3 Launch and recovery from a boat ramp

The FRB crew should consider the following factors before launching the boat.

- It is safer to launch a FRB from a prepared launch site rather than from an improvised launch site.
- The urgency of the task might dictate that it is a better proposition to launch the FRB at a prepared site and travel 10 km to the scene of the operation. However, if the scene of the operation is 40–50 km from a prepared launch site, it might be quicker to transport by road and launch at an improvised site closer to the area of operation.
- Fuel usage over long distances and the operational range of the FRB will often determine the acceptability of a launch site.
- The availability of a four-wheel drive vehicle. Nearly all launches from improvised sites necessitate the use of a four-wheel drive vehicle and, at the very minimum, a winch or Tirfor.
- Is vehicle access to the area of operation possible?

5.3.1 Launching from a boat ramp



Prepare the FRB away from the public boat ramp, so others can use the ramp. Most boat ramps have a rigging/derigging area to prepare for launching or towing.

Boat ramps are often very slippery and may have hazards such as broken bottles around them. FRB crew members should wear appropriate footwear and be careful.

FRB crew members should do a pre-launch check at the boat ramp rigging area. Complete the following checklist before launching the FRB.

PRE-LAUNCH CHECKLIST			
ITEM	CHECK	ACTION	
Boat	Tie-downs/safety chains	Remove boat tie-downs. Remove engine stand. Loosen (but do not remove) safety shackle.	
	Bungs	Put bungs in place and secure.	
	Ropes and lines	Attach a bow line to the front of the boat. Prepare mooring lines if needed.	
Trailer	Lights	Remove light bar if needed.	
	Brakes	Engage override latch for reversing.	
Motor	Prepare for starting	Open fuel tank breather. Connect fuel lines. Prime fuel bulb. Switch battery on.	
	Prepare for launch	Trim motor up. Put key in ignition. Fit kill switch lanyard (to the ON position).	
Communications	Radio	Conduct radio check with the local unit.	
	Departure report	Report departure, including: <ul style="list-style-type: none"> • task details • crew on board • estimated time of return • estimated time of SITREPs (situation reports) • any other relevant information. 	

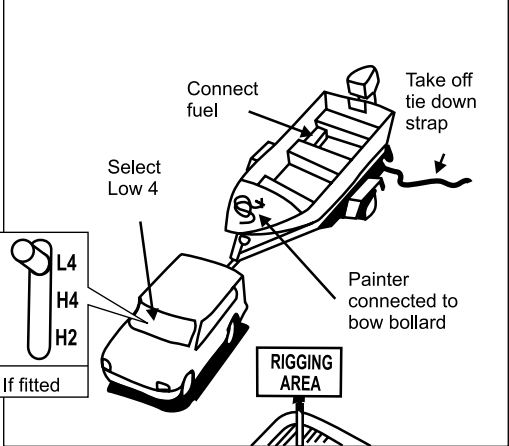
FRB crew members should use the following procedure to launch from a boat ramp.

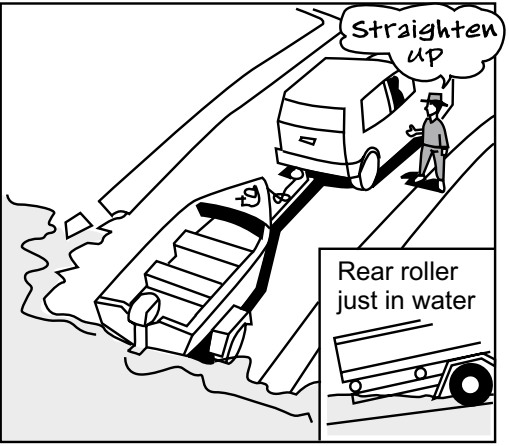
<h2 style="margin: 0;">LAUNCHING PROCEDURE</h2>	
<p>1. Complete the pre-launch checklist.</p>  <p style="text-align: center;">Figure 5:4a</p>	<p>Use the pre-launch checklist.</p>
<p>2. Check for hazards.</p>  <p style="text-align: center;">Figure 5:4b</p>	<p>Check the ramp and water for debris and sudden drops to ensure the ramp is safe and the water is deep enough for safe launching.</p>
<p>3. Reverse the trailer into the water.</p>  <p style="text-align: center;">Figure 5:4c</p>	<p>Using a guide, reverse to the water.</p> <p>Only reverse the trailer into the water as far as necessary to launch the boat. Factors affecting this include:</p> <ul style="list-style-type: none"> • the type of FRB and trailer • ramp angle—the shallower the ramp angle, the further the trailer needs to be reversed into the water. <p>As a guideline, only the bottom of the transom or rear roller needs to be at water level to successfully launch a boat.</p> <p><i>Tip:</i></p> <p>Avoid having crew in the boat while it is being reversed to the water's edge. If this is unavoidable, make sure they board at the water's edge and are sitting and hanging on.</p> <p><i>Note:</i></p> <p>Cold water entering warm wheel bearings can cause trailer wheel bearing failure, particularly if the water is salty. Allow wheel bearings to cool down before launching.</p>

4. Check the vehicle is secure; prepare to push the boat off.

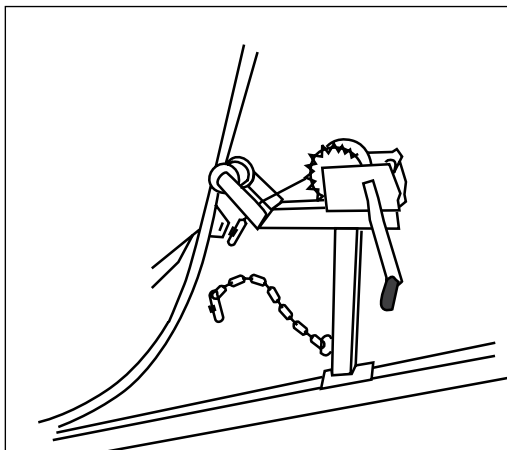

Figure 5:4d

Secure the vehicle—set the handbrake, select first gear and turn the engine off. On steep ramps the driver may have to stay in the vehicle with a foot on the brake or the wheels may need to be chocked.

Remove the safety chain and winch straps.

5. Launch the boat.



Figure 5:4e

Push the boat from the trailer, making sure someone is holding the bow line (also known as a painter).

Tip:

Many trailers have a trailer tilt mechanism, which is very handy for launching on shallow angle ramps. If it is fitted, find the release handle and use it if needed. Do not forget to lock it back down after use or it could tilt while driving along.

6. Secure the boat.

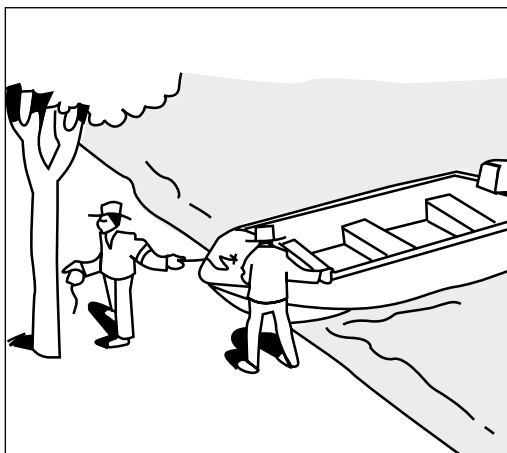

Figure 5:4f

Secure the boat to the bank, jetty or shoreline.

7. Park the car and trailer.

Park the car and trailer well above likely flood or tide heights.

WARNING

Do not disconnect the safety chain and winch wire/rope until the boat is ready to be pushed from the trailer. Modern boat trailers use very slippery strakes and rollers for easy launching, and an unsecured boat will easily slide off. Loosen (to finger-tight) the safety chain shackle pin before reversing down the ramp to avoid using tools at this time.

5.3.2 Driving the FRB from the trailer

Some FRBs (large punts) can be driven off the trailer. First, follow the launch procedure up to the point that the trailer is in the water and the vehicle is secure. Once the trailer is in the water:

- Board the FRB at the water's edge. **Remember**, the minimum number of crew is two at all times when underway.
- Ensure there is enough water to lower the motor(s).
- Trim the motor down until the propeller and water intakes are covered by water. Do not trim the motor down fully, as the transom can dip as the boat comes off the trailer, which may cause the skeg to crash into the bottom.
- Connect the motor kill switch lanyard and start the motor(s). Check that the motor is pumping water.
- Disconnect the winch strap and safety chain.
- Engage reverse gear and drive the boat straight back. The boat may also need pushing at the same time until it is free of the trailer.

5.3.3 Winch-on recovery

FRB crew members should use the following procedure for winch-on recovery from a boat ramp.

1. Prepare the boat and trailer.

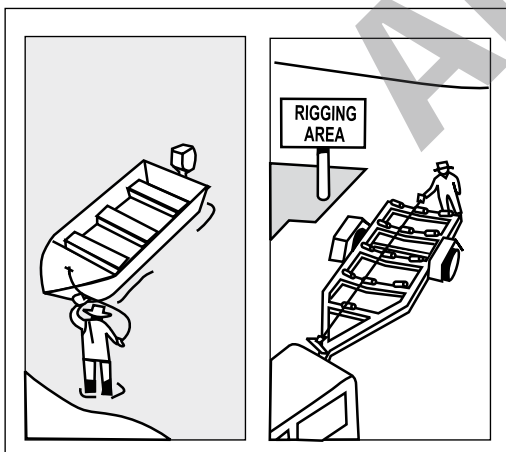

Figure 5:5a

Attach a bow line and trim the motor up.

Run out the winch wire to the end of the trailer and hook it to the chassis. Ensure the safety chain shackle pin is free.

Put the vehicle into low range. Only lock the hubs if it is on loose or slippery surfaces.

2. Reverse the trailer into the water.

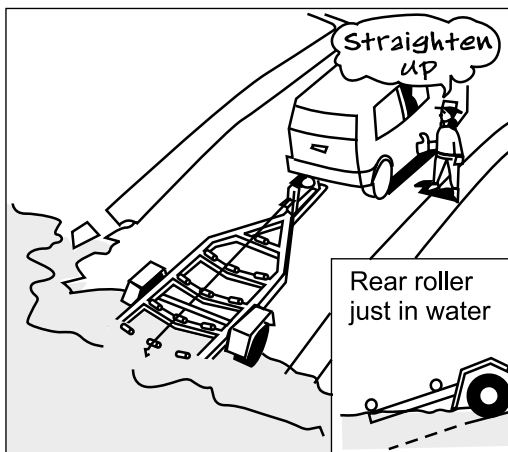

Figure 5:5b

Reverse the trailer into the water, taking care not to submerge the wheel bearings where possible. Ensure the vehicle is secure.

3. Place the boat on the trailer.

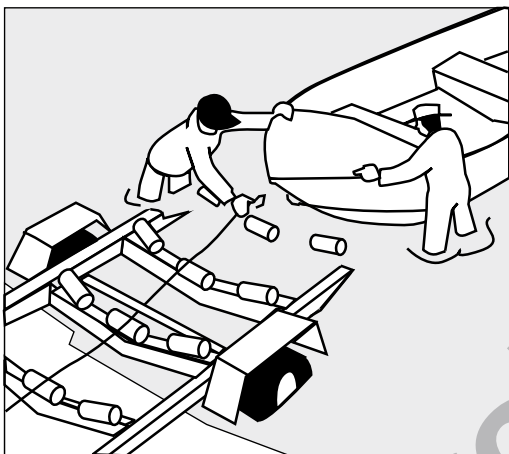

Figure 5:5c

Crew members move the FRB to the rear of the trailer and rest the bow on the rear roller, then hook on the winch wire to the bow eyelet.

The bow line will also help position the boat.

Ensure the outboard motor is trimmed up to avoid hitting the ramp.

4. Winch on.

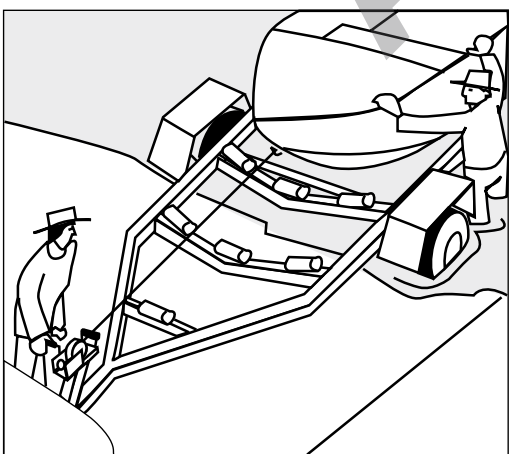

Figure 5:5d

Wind in the winch with the ratchet engaged while crew members steady the FRB and keep it in line with the trailer.

Use the trailer tilt if necessary.

5. Attach the safety chain.

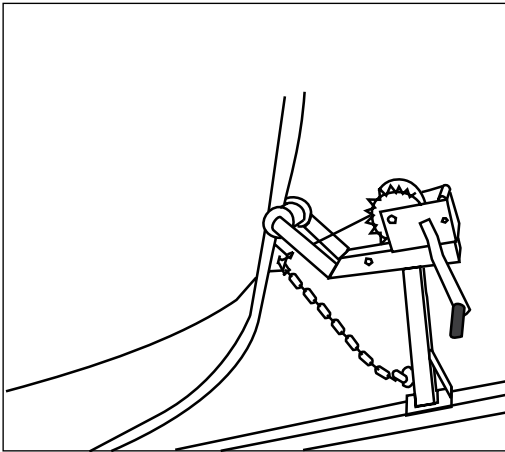

Figure 5:5e

Attach the safety chain after the bow is secure against the winch post.

6. Drive to a rigging area and complete post-recovery checks.

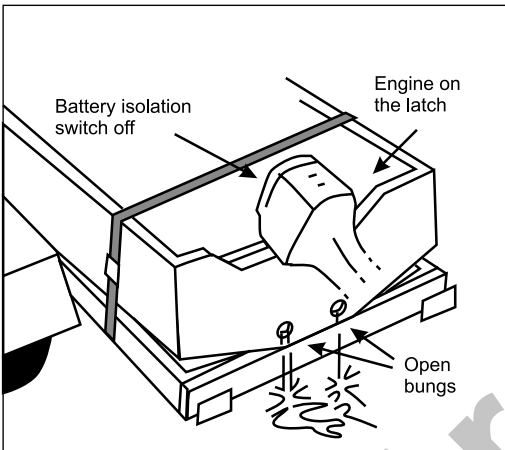

Figure 5:5f

Use the post-recovery checklist (below).

5.3.4 Drive-on recovery

Some boat trailers are designed for drive-on recovery. This can easily cause damage to the boat and trailer, so ensure an experienced operator is supervising.

After preparing the boat and trailer for recovery as for a winch-on recovery:

1. Reverse the trailer to the water's edge.

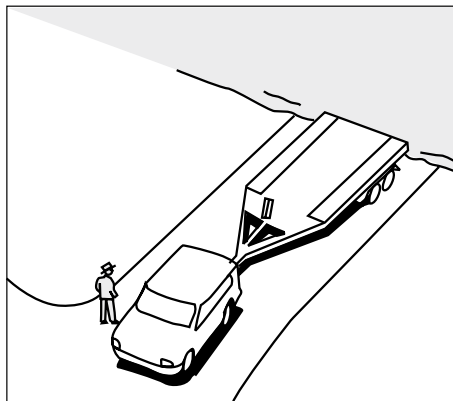

Figure 5:6a

Reverse the trailer into the water and check that the vehicle is secure.

The trailer may need to be reversed further into the water than for a winch-on recovery. How far will depend on the ramp angle, depth of water and type of boat being recovered.

2. Guide the boat driver.

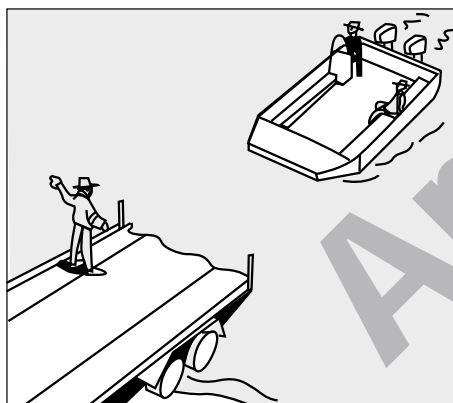

Figure 5:6b

Using a guide is the safest way to avoid damage to the boat and trailer. Use clear hand and voice signals to direct the boat to the trailer.

The boat should approach as slowly as possible. Stop the boat at the end of the trailer.

3. Guide the boat onto the trailer.

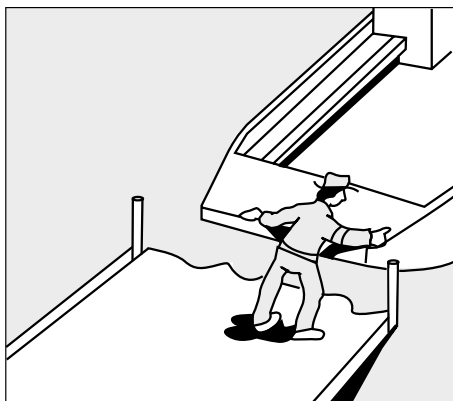

Figure 5:6c

A crew member should stand on the trailer and guide the bow of the boat onto it.

This is done manually; the engines should be in neutral.

4. Trim motors up for shallow drive and drive the boat on.

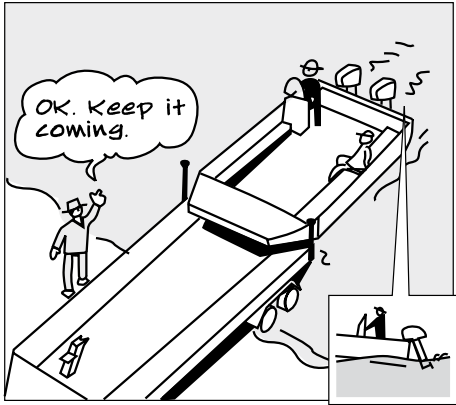

Figure 5:6d

Once the boat's bow is located on the trailer, engage forward and drive slowly onto the trailer.

Ensure the motors are trimmed up for shallow drive to avoid a skeg or propeller strike. This can happen when the transom dips as the bow mounts the trailer. Drive the boat up slowly using a guide.

5. Attach the winch and safety chain.

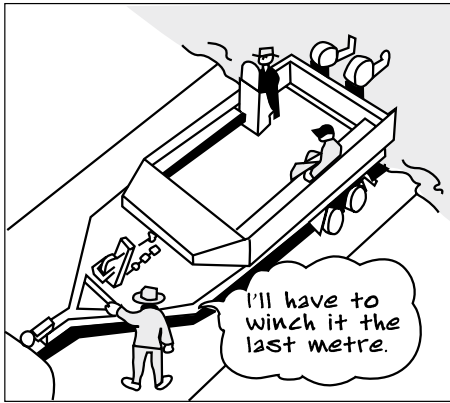

Figure 5:6e

It may be necessary to winch the boat for the final metre or so. Before towing the boat away, ensure the winch cable and safety chain are attached.

Archived

5.4 Launch and recovery from an improvised site

Sometimes a FRB needs to be launched where there is no boat ramp and crew members need to improvise. Potential sites include shorelines, banks or any places where the FRB can reach the water. Often in flood conditions a steep road can be used where it dips down into the floodwater.

5.4.1 Safety during an improvised launch

When launching from an improvised site use the **stop and take 5** rule.



1. Stop, stand back and observe

- Inspect the site.
- Choose a spot where the bank is least steep and most even.



2. Think through the task

- Is the launch site suitable?
- Is the route to the launch site driveable?
- Is there enough water to launch into?
- Are there any underwater hazards?
- Is there a better option?



3. Identify hazards

- Are there ruts, washaways and boggy ground?
- Are the river banks high?
- Are there deep drop-offs in the water?
- Are there strong currents?
- Is there heavy debris in the water?
- Are there powerlines?



4. Assess and control risks

- Fill in ruts.
- Clear logs and debris.
- Use four-wheel drive vehicles or winches.
- Find a more suitable site.



5. Continually monitor risks

Once the risks have been assessed and controlled, crew members should launch the FRB following the steps they would use at a boat ramp.

There is a possibility of a launching vehicle sliding on a slippery ramp surface into the water. Drivers may choose not to wear a seatbelt and have the windows down during the launching operation. Chocking the wheels of the tow vehicle can help secure the vehicle while the boat is launched.

A tow ball mounted to the front of the vehicle may help if improvised sites are used regularly.

5.4.2 Improvised launch without a vehicle

If the bank is too steep to use a vehicle, the following techniques can be used:

- vehicle or manual winch
- rope system
- carry/drag
- beach rollers/logs.

When using a winch/rope system:

- reverse the trailer as close as possible to the launch site
- chock the wheels of the trailer then disconnect it from the tow vehicle
- secure the winch/rope system to the trailer
- as the winch/rope system is payed out, guide the boat and trailer down the bank.

When the trailer is in a position where the boat can be launched, tilt the trailer and allow the boat to slide off into the water with the following precautions:

- a. Never disconnect the boat winch cable from the boat until the boat is ready to be launched.
- b. Never step over a winch cable or rope while it is under tension.
- c. Always use gloves when handling steel wire rope.
- d. Use a log or bag to prevent the cable/rope from dragging or cutting into the top edge of the bank.
- e. It may be necessary to extend the length of the winch cable by using a winch extension strap.
- f. On very steep launch sites, in most cases, launching a FRB down a vertical or near-vertical incline can be made easier by sliding the FRB off the trailer and lowering it over the edge with the aid of ropes and/or winches.

- g. Care must be taken not to let the progress of the boat get out of hand:
- at no time must anyone be between the boat and the water
 - if the motor is fitted, always launch the boat with the motor in the tilt position to prevent fouling.

Crew members should use their general rescue skills to help in these jobs.

Always check equipment for damage before packing, especially equipment that may be used in the next operation.

It may be possible to use the vehicle with a redirected tow line as in Figure 5.7.

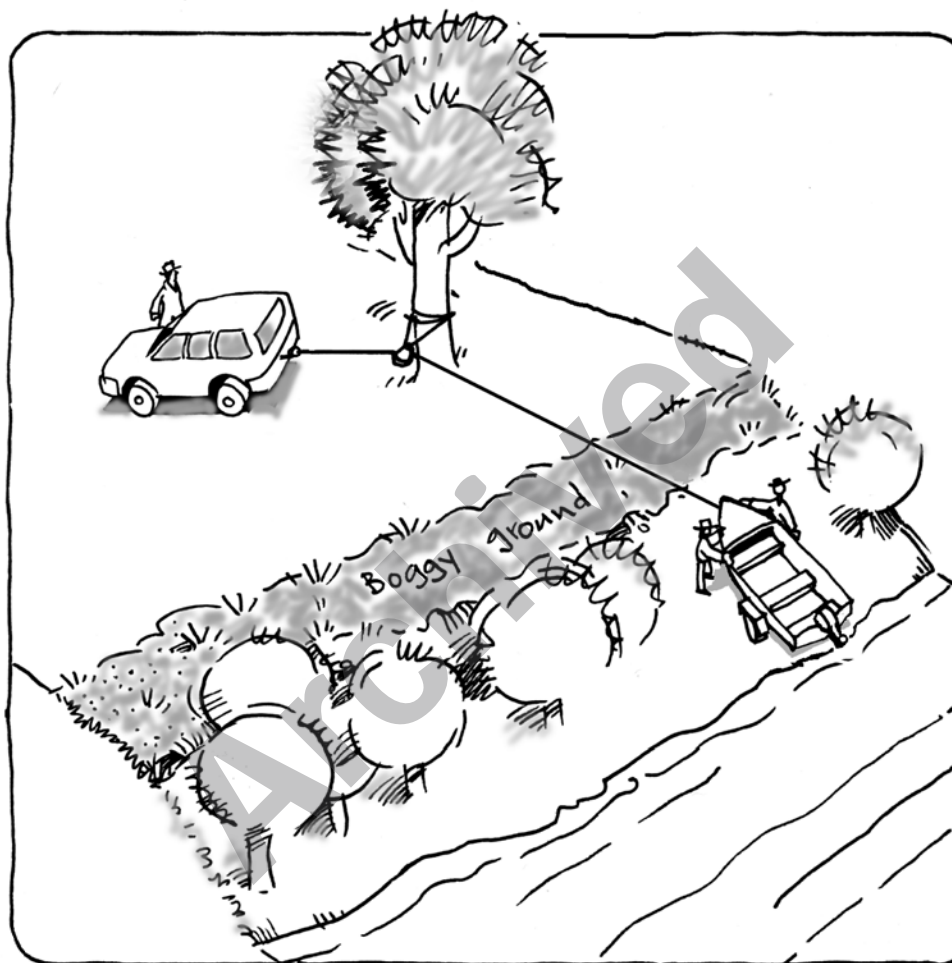

Figure 5:7

Improvised recovery

5.5 Post-recovery checks

Once the FRB has been recovered, prepare the boat for towing. Use the post-recovery checklist as a guide and complete it at the boat ramp rigging area.

POST-RECOVERY CHECKLIST			
ITEM	CHECK	ACTION	
Boat	Tie-downs/safety chains	Fit boat tie-downs. Fit engine stand. Check safety shackle and winch cable (winch up fully if needed). Stow winch handle.	
	Bungs	Remove bungs or open scuppers.	
	Ropes and lines	Stow all ropes and lines.	
	Equipment	Stow and/or tie down equipment.	
Trailer	Lights	Fit and test light bar.	
	Brakes	Disengage override latch for towing.	
	Coupling	Check security of safety chains/shackles. Check coupling is on tow bar, locked down fully, safety clip in place.	
Motor	Prepare for travel	Close fuel tank breather. Disconnect fuel lines. Switch battery off. Put motor in travel position. Remove key and kill switch lanyard; stow in a secure place.	
Communications	Return report	Report return, including: <ul style="list-style-type: none"> • estimated time of arrival at local unit • any other relevant information. 	

5.6 Launch site hazards

Major hazards can be encountered during a launch from an improvised site. No matter what the hazard may be, remember that it is better to slow down and launch smoothly rather than make haste and damage the boat.

Prepare an improvised site by removing obstacles (eg rocks and branches). Use hand tools to fill in holes and flatten the intended course if needed.

Some of the major hazards are:

- **sand**—it is difficult to launch a FRB from dry sandy areas without the aid of a four-wheel drive vehicle. Even with a four-wheel drive, it may be necessary to lower the pressure in the tyres of the vehicle and the boat trailer. The main factor to remember when operating (driving) in sand is not to spin the wheels. Once the wheels start spinning, the vehicle may become bogged. Clearing sand away from in front of the wheels and/or winching are usually the options available in these circumstances.
- **mud**—mud greatly increases the hazards of launching from improvised sites. Crew members must use great care when operating on steep muddy slopes. The loss of footing can result in one or more crew members in the water or someone being run over by the trailer or vehicle. Vehicles do not have the same traction in muddy conditions, so the vehicle may have to be secured to a tree or some form of anchor. Improvised anchors can include vehicles, trees, fence posts and pickets.
- **crosswinds/currents**—strong crosswinds and currents may require the aid of a person to hold a rope tied to the stern cleat and to stand on the upwind/up-current side of the boat to keep the boat in line with the trailer until the boat is fully launched. The bow line can also be used as a belay around the winch post to control the speed at which the boat is launched from the trailer.
- **onshore wave action**—for lake or sea launches, when the wind and wave action is directly onto the launch site, care must be taken that waves do not wash over the boat and swamp it.

5.7 Restoring the FRB

After an operation, check and service the FRB and its equipment so it is ready for the next crew or the next day. Crew members should ensure they:

- flush the motor
- clean the FRB
- service and prepare the FRB for further action or garaging
- report any defects
- fill in the FRB's logbook.

End of chapter. This page left intentionally blank.

Archived

CHAPTER 6

Driving and Handling the FRB

FRB crew members should get to know how their FRB handles, which will help in making safe decisions when operating the boat and in handling the boat well. Sometimes crews may have to use different boats, so they should take time to familiarise themselves with other boats, which may handle quite differently to the one they are used to.

6.1 Boarding small vessels

It is important to understand stability when boarding FRBs.

Boats are most stable when the load is kept low and even. If two or three crew members board a small V-hull FRB at the same time and on the same side, the boat could dip the gunwale and capsize. Crew members should board the boat one at a time and spread the weight of the crew and the load around to keep the boat level and stable.

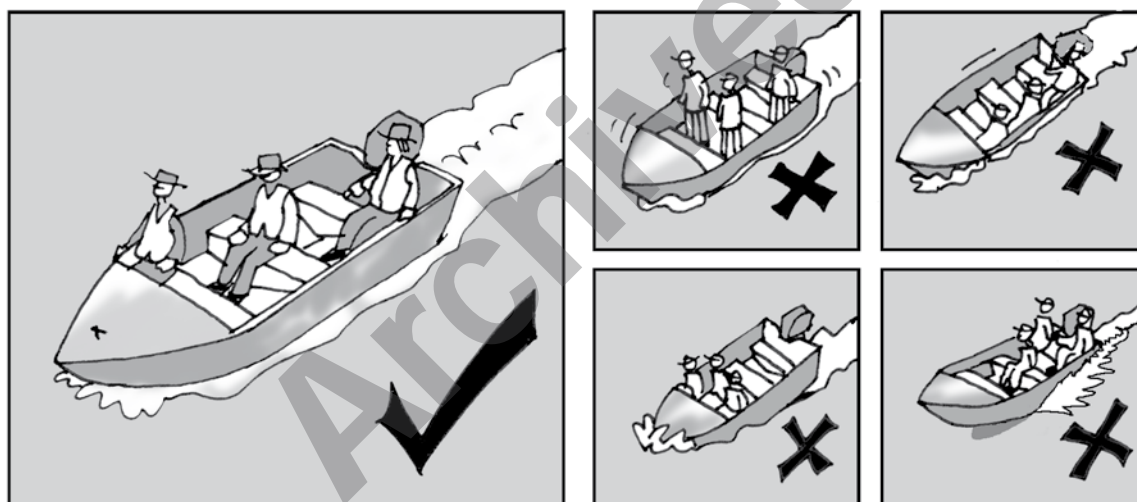

Figure 6:1

Trim

Important points for crew members to remember are:

- step aboard amidships (in the middle) where possible, crouch down and hold onto something
- never jump into a FRB or pause with one foot aboard and the other foot ashore
- when moving about the FRB, keep to the centre line and crouch down to lower your centre of gravity and hold on
- check the FRB's capacity sticker or compliance plate for the legal number of occupants allowed.

6.2 Start-up procedure

Crew members should use the following start-up procedure:

- a. Have a crew member hold the bow or tie the boat to the bank. The crew member may have to hold the boat by the side and keep the bow pointed into the wind, waves or current if needed.
- b. Check the boat for leaks.
- c. Check the boat's trim—move the load around to trim it correctly if needed.
- d. Move the stern into deeper water so the propeller is clear of the bottom when lowered.
- e. Trim the motor down until the water intakes are under water.
- f. Attach the kill switch lanyard to the kill switch and to the coxswain's wrist.
- g. Put the throttle in neutral.
- h. Start the motor and apply choke and/or neutral throttle advance, if needed.
- i. Once started, check that the water pump is working by looking at the telltale.
- j. When the motor is warm and should not stall, the crew member holding the bow should push the FRB towards deeper water and then board.
- k. The coxswain should reverse out.

Remember: never start the motor out of the water. The impellor requires water for lubrication.

6.2.1 Emergency starting

Many outboard motors have provision for emergency starting. Details of emergency starting procedures can be found in the owner's manual.

6.3 Lookout

FRB crew members should keep a good lookout by looking and listening. A crew must be fully aware of the surroundings, especially in bad weather, poor visibility and darkness.

The crew leader is accountable for the safety of the FRB and crew at all times; however, all crew members are responsible for keeping a lookout for hazards and reporting them. Not all collisions occur with other vessels.

Look all around—even behind the boat. Be familiar with the local area.

6.4 Driving the boat

6.4.1 Accelerating

To accelerate in forward and reverse:

- trim the motor in (see below)
- engage the desired gear
- apply throttle smoothly until the desired speed is reached.

This will allow the boat to accelerate from a standstill to up on the plane efficiently. This is known as a 'hole shot'—getting the boat 'out of the hole' and up on the plane.

Select gears quickly and positively. Trying to ease the motor into gear will grate the gears and may cause gear damage.

Look behind and around the boat before selecting reverse gear.

The coxswain should tell crew members when he or she is about to accelerate, turn or reverse so they can sit and be ready, and not be thrown around and hurt.

Did you know?

FRBs have powerful motors for running with heavy loads and in fast-flowing water. It may be dangerous to run at full power in some unloaded boats. In particular, punts can lose control from porpoising at a fast speed in a straight line.

6.4.2 Safe speed

A safe speed is a speed at which the boat can be stopped in time to avoid a collision. Collisions are usually caused by not travelling at a safe speed. Sometimes collisions are with underwater hazards that cannot be seen (eg trees in a lake). When working in a dam with low water levels and dead trees, many underwater hazards will exist. In these cases travel at a speed where hitting something will not cause damage or injuries (ie dead slow—idle speed). A safe speed is always slower at night and in poor visibility.

6.4.3 Reversing

Boats and propellers are designed to push boats forward and they work most efficiently in that direction. They work much less efficiently in reverse because the transom is flat and will push a lot of water as the boat reverses. A boat should only travel in reverse slowly. If a boat is reversed quickly, water may come over the transom into the boat and could swamp it.

With manual trim motors, ensure the motor is locked down or it will climb out of the water when reversed.

6.4.4 Stopping

Outboard motors have the advantage that the normal boat rudder is replaced by a propeller, and steerage, even at slow speeds, is generally positive and effective.

Once the propeller stops, however, the boat loses some steerage. FRB operators must travel at a speed appropriate to conditions, avoiding the need for emergency stops. When operating in a current, the coxswain should assess the situation and select an appropriate method to slow down or stop. Some methods are:

- throttle back and stem the current
- turn into the current and then stem it
- manoeuvre into slower moving water.

It is important to understand how to stop a boat because, unlike a car, there are **no brakes**.

To slow down:

- reduce the motor revs to idle—the friction of the water on the hull will slow the boat.

To slow quickly:

- pause the engine in neutral (allowing the engine revs to drop to idle) and engage reverse gear. Once the reverse thrust is great enough, the boat will come to a stop.

Do not hold the neutral lock release and run the motor from forward to reverse. It may stall the engine or damage the gearbox.



Figure 6:2
Neutral lock

6.4.5 Trimming the motor

Outboard motors are trimmed to:

- maintain propeller clearance in shallow water
- help the boat get onto the plane
- gain maximum efficiency when planing
- set the attitude of the boat for handling different water conditions.

The motors on many FRBs have power trim and tilt. The coxswain can:

- **trim out**—move the propeller out, away from the transom
- **trim in**—move the propeller in towards the transom by moving the trim switch
- **tilt** the motor up out of the water by continuing to trim out.

Before trying to move the boat, ensure the motor is trimmed in. This holds the bow down and helps the boat get out of the hole and onto the plane. Once the boat is planing, trim the motor out until:

- the boat frees up
- the revs increase (without adjusting the throttle)
- the steering lightens as the bow lifts.

Setting the correct trim will vary depending on the load in the boat and wind and wave conditions. Crew members need to practise this skill, watching the difference between engine revs and speed, as these are good indicators of correct trim.

As a guideline for good trim, crew members should get the boat up and planing and trim the motor to be perpendicular with the water or get the motor cowling parallel to the water.

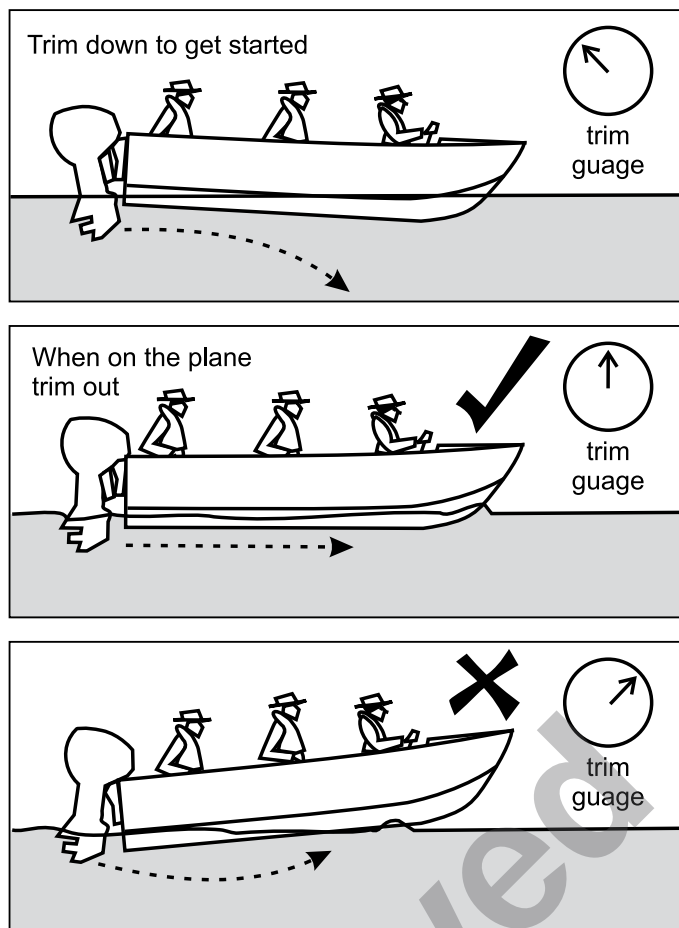

Figure 6:3
Power trim

Other points to remember in relation to trim are:

- **ploughing**—boats will run nose down (ploughing by the head) when the motor is trimmed in fully. A boat trimmed like this will be heavy to steer and need more power to maintain speed. Trimming out will improve this, as it lifts the bow and lightens the steering.
- **cavitation**—if the motor is trimmed out too far, the propeller may suck air in from the surface (cavitation), making it spin faster, lose grip and slow the boat. It may also over-rev the motor. To stop cavitation, trim the motor back in and/or ease off the throttle.
- **porpoising**—too much trim may also cause the boat to porpoise, which is when the bow rises and falls. If this happens, trim the motor back in and/or ease off the throttle until control is regained.
- **manual trim**—many boats do not have power trim, which means the trim cannot be adjusted on the move. The trim is adjusted manually by moving a locating pin near the mounting bracket of the motor.

Crew members should set the trim on a day when they are able to practise with the FRB, to see how it feels. A good position for most conditions is when the FRB gets up onto the plane well, and has good handling characteristics at speed.

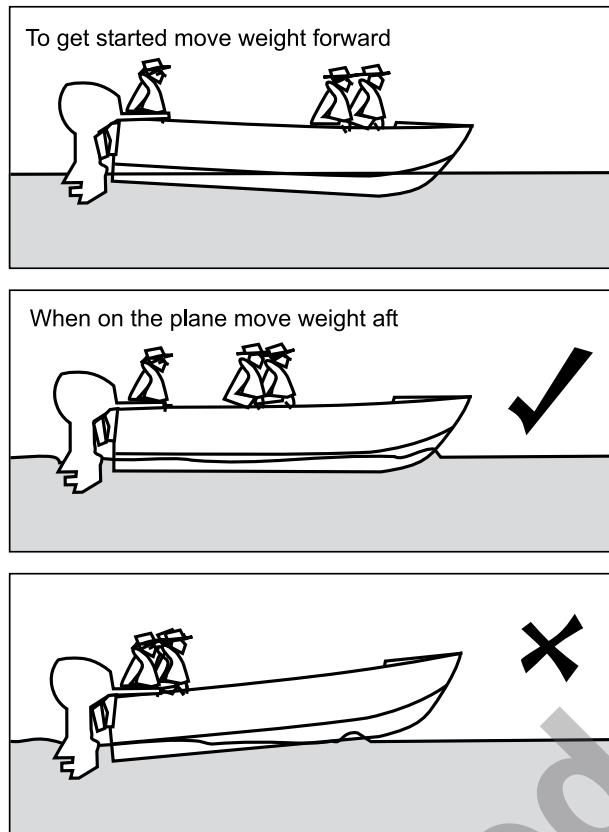

Figure 6:4
Manual trim

Did you know?

The trim of the boat can be adjusted by moving weight forward or aft in the boat. For example, to get the boat on the plane easier, put a crew member up in the bow. This helps keep the bow down and gets the boat out of the hole quickly. Once out of the hole, move the crew member aft to get the best trim for continued planing.

6.5 Steering the boat

Boats with outboard motors are steered by the thrust of the propeller, and the outboard leg acts as a rudder. A rotating propeller bites into the water, converting a lot of its power into thrust. Power not used in forward momentum is dissipated sideways, giving a sideways thrust. Although this effect is relatively small, it makes itself felt, particularly at slow speeds.

It is important to understand that boats steer differently to cars. Cars steer by the front wheels but boats steer by the stern and the power of the motor pushing the boat. When going forwards the boat pivots at a position just forward of the centre of the boat. This causes the stern of the boat to swing wide in turns.

In reverse, the boat pivots at a point near the stern of the boat. The engine, in effect, 'pulls' the boat around. Because the back of the boat is turning, the bow swings wide when turning.

Sometimes crews may have to use different boats, so they should take time to familiarise themselves with other boats, which may handle quite differently to the one they are used to.

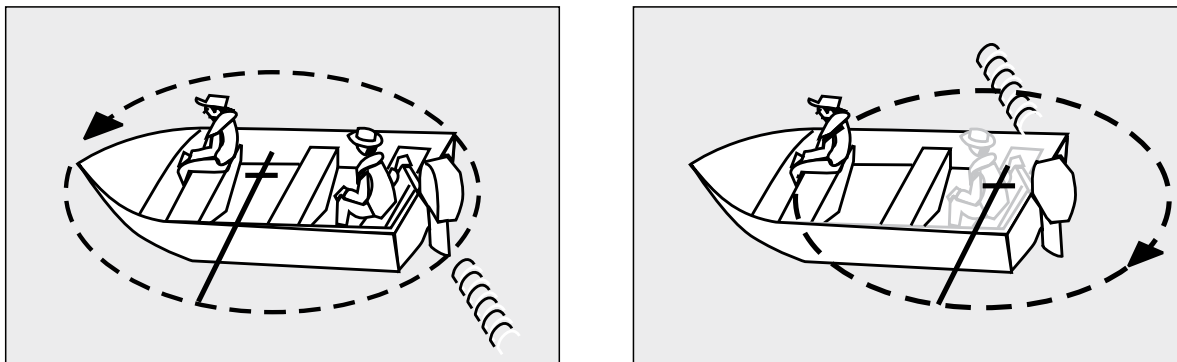

Figure 6:5
Steering pivot point

Did you know?

Boats steer best when driving into the wind or current, so when approaching something (eg a jetty or person in the water), it is best to approach into the wind and current, or the stronger of the two.

6.5.1 Steering with a tiller

When going forward, the coxswain should move the tiller in the opposite direction that he or she wants the boat to go. If steering to the left, pull the tiller to the right.

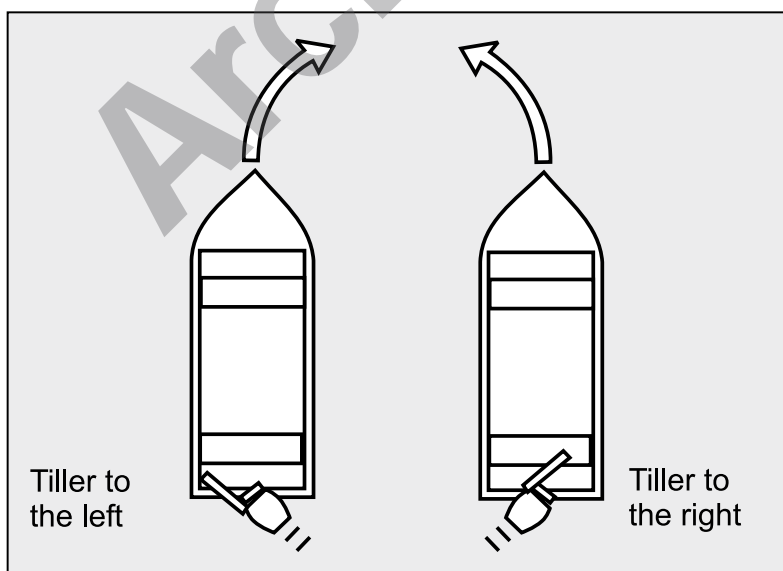

Figure 6:6
Steering with tiller

6.5.2 Steering with forward/side controls

A FRB with a steering wheel steers in the same way as a car—steer left, go left; steer right, go right.

6.5.3 Turning

When steering and turning, it is good practice to slow down before the corner and accelerate smoothly out of the corner. Crew members should understand the characteristics of turning a boat:

- turning radius—all boats turn differently due to their hull shape, size, loading and the conditions (eg because large punts tend to slide around turns, they need far more room to turn than V-hulls)
- **tight turns**—most boats can be turned more tightly by applying some throttle during the turn, which helps push the stern of the boat around quicker
- **fast turns**—most FRBs can be run and turned at fast speeds. All boats handle differently in fast turns and it is important to know how a particular boat handles. Generally, the deeper the V of the hull, the tighter and faster the boat will be able to turn. Flat bottom boats (eg punts) will turn at fast speeds but tend to skate sideways in the turn and have a bigger turning radius. They can also overturn in extreme cases if they hit waves or wakes side-on in fast turns. Small punts can be turned more quickly by moving the crew's weight to the inside of the turn.

Remember: Newton's second law of motion: objects in motion—like the crew—tend to keep moving.

WARNING

It is possible to turn too tightly at too high a speed, and lose control of the boat. This can be extremely dangerous. Both punts and V-hulls are capable of biting in a hard, fast turn, causing the crew to be thrown from the boat.

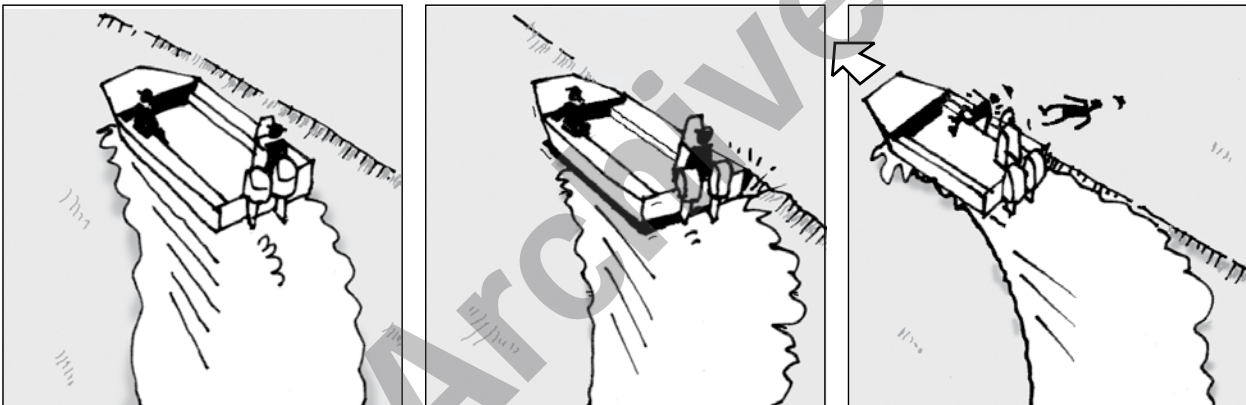

Figure 6:7a
Fast and tight turns



Figure 6:7b
Fast and tight turns

6.5.4 Turning around using the three-point method

This method can be used where turning space is restricted. To turn a boat around using the three-point method, the coxswain should:

- a. Put the helm hard to starboard or port, slow ahead. After turning part-way select neutral.
- b. Put the helm hard to port or starboard, then engage slow astern. After turning part-way, select neutral.
- c. Hold until the FRB is turned around and engage forward.

Turning the motor while in neutral increases the turning response when the gear is engaged.

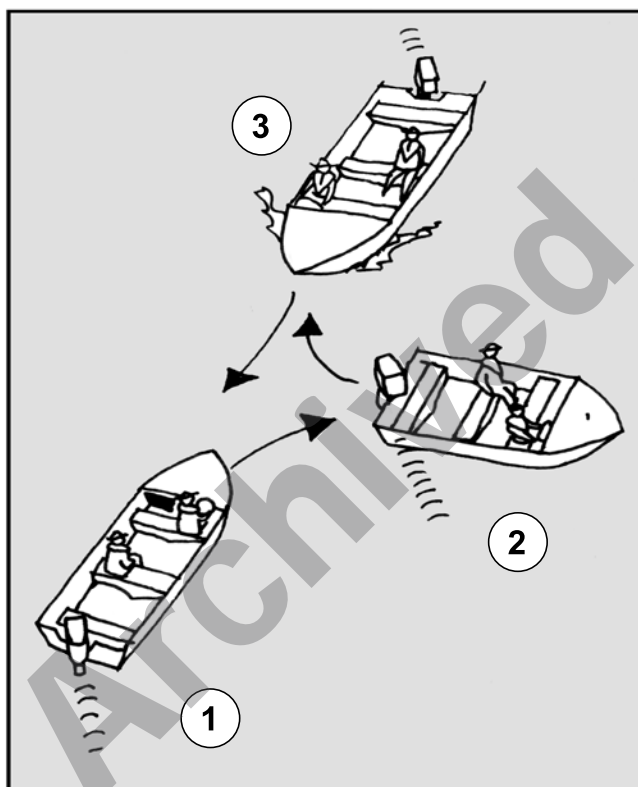

Figure 6:8
Three-point turn

6.5.5 Turning around using twin outboards

This method can be used to turn boats with twin outboards in confined space. Twin outboard vessels are very manoeuvrable at low speeds using one or both motors.

To turn tightly using one motor:

- lock the wheel opposite to engine power
- turn the wheel hard over to the starboard, go ahead on port motor, and engage neutral
- turn the wheel hard over to port. go astern on starboard motor, and engage neutral
- turn the wheel hard over to starboard, go ahead on the port motor
- straighten the wheel when the turn is complete, engage the starboard motor and match the engine revs.

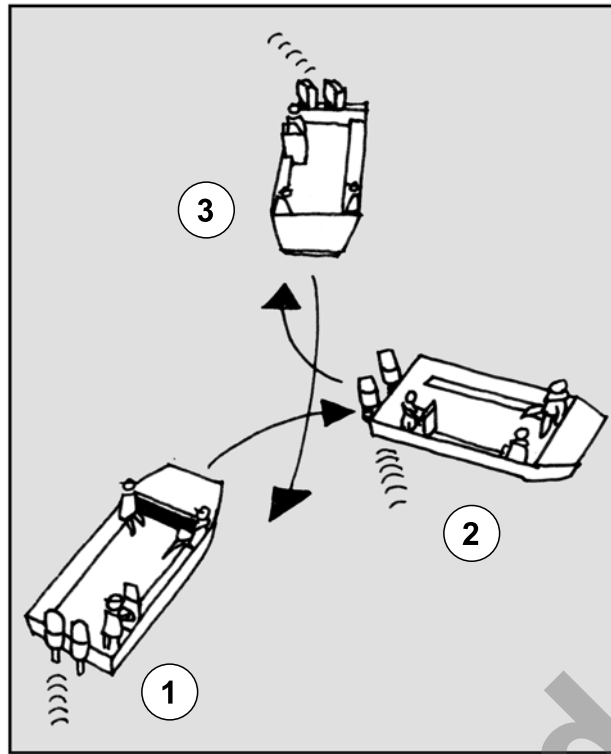

Figure 6:9
Turning with twin outboards

6.5.6 Pivot turn using twin outboards

Twin outboard boats can pivot turn by using the motors in opposition to each other. To do this:

- turn the wheel hard over to starboard; go ahead on the port motor; go astern on the starboard motor
- when the boat has turned around, go ahead on the starboard motor (remember to pause at neutral before engaging forward gear)
- straighten the wheel.

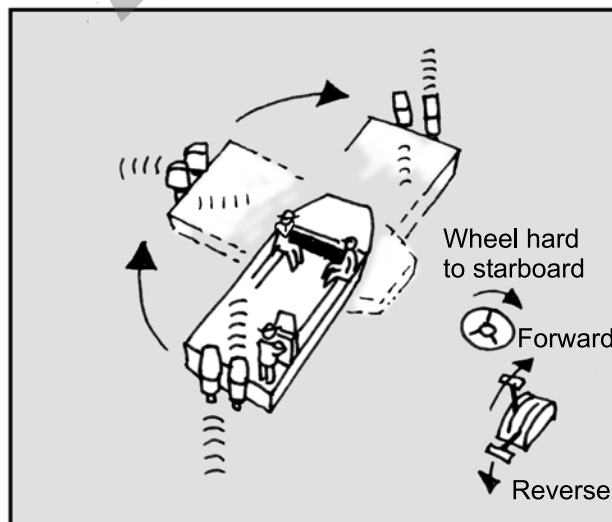

Figure 6:10
Pivot turn using twin outboards

6.6 Beaching

In FRB operations it may be necessary to land on beaches or river banks. Crew members should bear the following points in mind.

- Select a landing point that can be approached safely and with minimum effort. Avoid landings in muddy areas or areas that require crew members to wade long distances through water.
- Allow for the effect of the current and wind when approaching the landing point.
- On the approach, slow down and keep clear of shallows.
- When close enough for the boat's momentum to reach the shore, select neutral and trim the motor out for shallow running.
- When the FRB has grounded, secure the boat. Turn the motor off and tilt it up.

In wind or currents, the coxswain may have to drive the boat all the way under power and hold the boat on the bank with power. Remember to trim the motor out to avoid propeller damage, but keep the water intakes under water while the motor is running.

Never attempt to beach at high speeds. Only go as fast as needed to make the shore. If possible, approach into the current or wind.

Remember: when landing people on a sloping beach or bank, FRBs tend to float away as each person steps out, so make sure the boat is secured. It is best to unload people on the upstream side or upwind side of the FRB to avoid the boat being swept on top of them.

6.6.1 Tying the boat on a bank

Use the methods outlined as required to tie your boat to a bank.

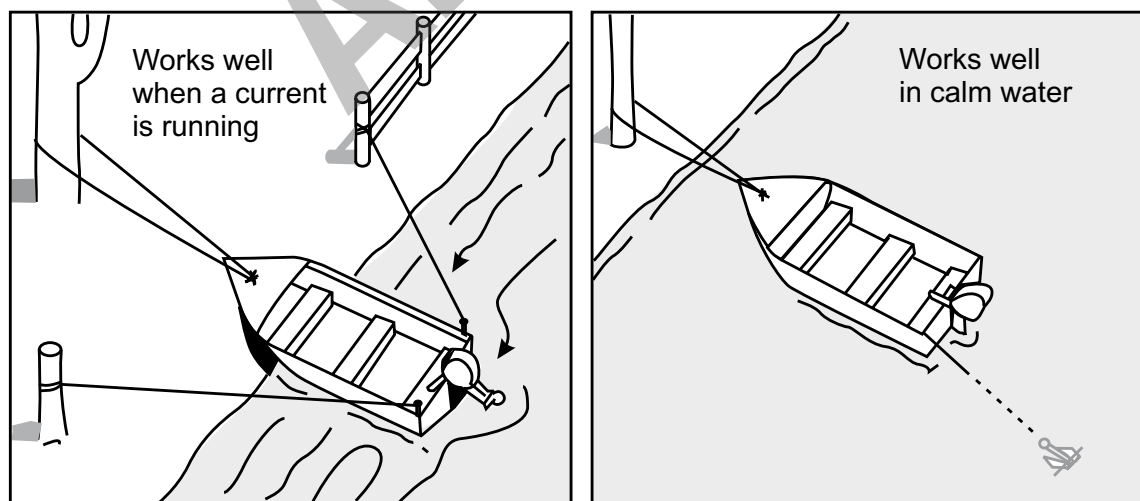

Figure 6:11

Securing the boat to a bank

6.7 Leaving a fixed structure

It is possible to move away from a jetty or pier by merely pushing the boat off and, once sufficient space has opened up between the boat and jetty, to go ahead slowly with a gentle outward turn. A sharp turn may mean that the stern of the vessel will hit the jetty with some force. This must be avoided. If the boat is being pinned to the jetty or wharf by the wind or current, it is best to reverse out (ie turn the outboard motor propeller away from the jetty and slowly apply power, in reverse, so that the propeller draws the boat smoothly and safely away). Take care to reverse far enough out from the wharf so that, when forward thrust is applied, the boat does not come right back to the wharf and hit it. When reversing, watch for waves that may come over the transom into the boat.

The two techniques below help to get clear of a bank, jetty or structure and into deeper water without damaging the boat or propeller.

6.7.1 Using a spring line (forward)

Most of the time, the coxswain can steer towards a bank or jetty and the bow will catch enough to allow the stern to pivot around into deeper water. If not, attach a **spring line** to a pylon, fence or tree and spring the boat's stern into deeper water away from the jetty or bank.

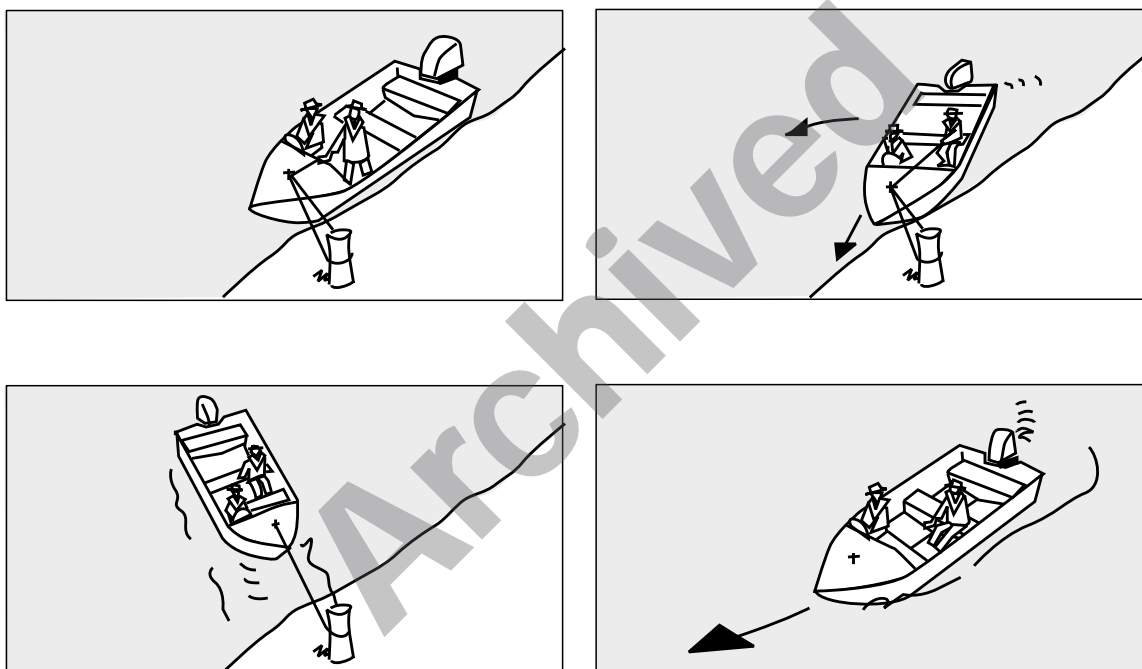

Figure 6:12

Moving off with a spring line

To leave a fixed structure using a spring line:

- attach a spring line
- wheel hard over to port
- engage forward and drive into the bank
- ease the spring line and reverse into midstream
- drive forward and straighten when well clear of the bank.

6.7.2 Using a spring line (reverse)

Sometimes reversing away using a spring line may be an appropriate option. This is useful when a strong wind is holding the boat on the jetty or shore and there are close obstacles to clear. This method allows the boat to get further into the waterway before the spring has to be released.

6.8 Coming alongside a fixed structure

Propeller torque, wind and current affect manoeuvres when coming alongside a fixed structure. It is essential to maintain safe momentum to maintain control of the boat. To achieve good docking always position the approach so that if the motor fails, any resulting collision will result in a slow and glancing blow.

The coxswain must be aware of the current and wind when coming alongside a dock, wharf, jetty or flooded house. Follow these steps when docking:

- approach as slowly as possible (Figure 6:13a)
- once there is enough momentum to get to the dock, select neutral and steer away from the building (starboard) (Figure 6:13b)
- when just off, wheel hard over to port and engage reverse gear (Figure 6:13c)
- when parallel, straighten the wheel. Reverse thrust if needed to stop (Figure 6:13d)
- secure the boat.

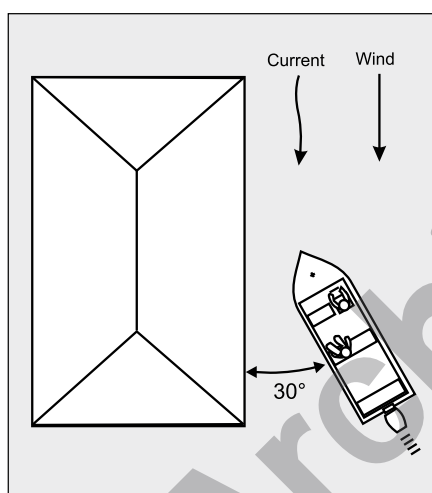

Figure 6:13a
Coming alongside

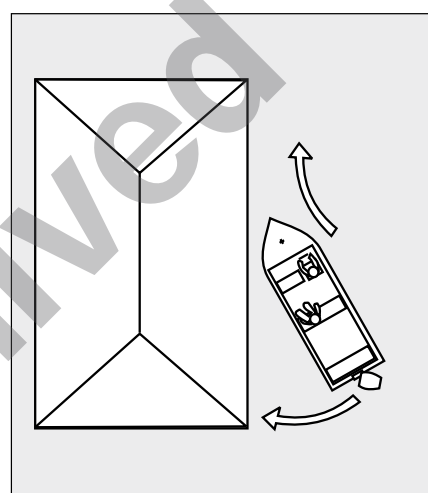

Figure 6:13b
Coming alongside

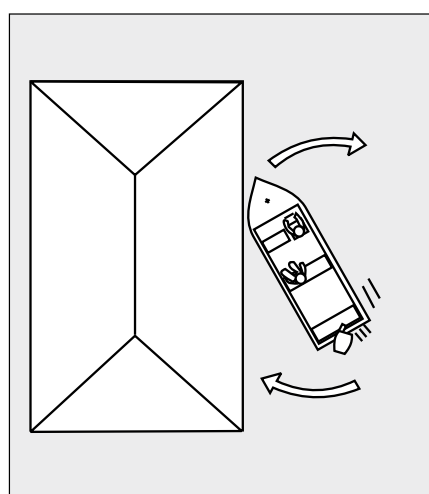

Figure 6:13c
Coming alongside

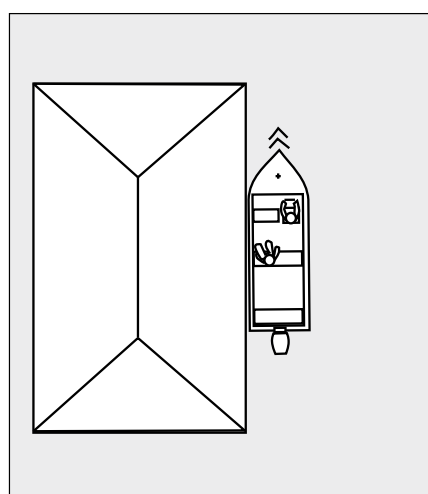

Figure 6:13d
Coming alongside

It is best to tie the FRB fore and aft alongside the shore or jetty, or even to the bank.

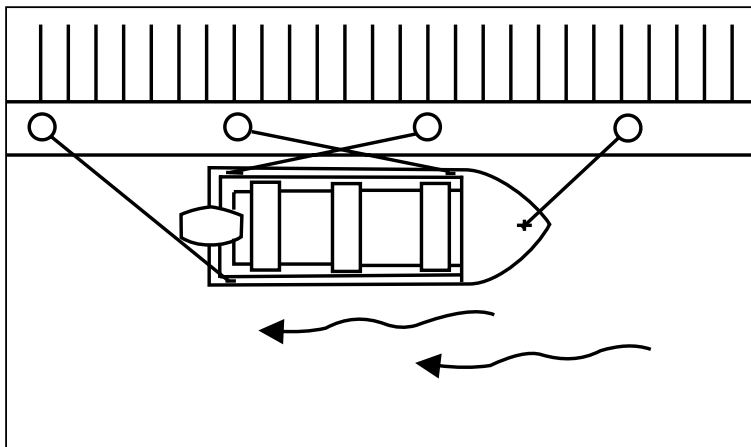

Figure 6:14
Securing to a jetty

WARNING

Keep hands and fingers away from the gunwale when docking the FRB. Plan the approach and adjust the speed so that the manoeuvre is controlled and safe.

6.8.1 Coming in bow on

When approaching a landing bow on, watch for wind, current and torque effect. The coxswain should:

- put the motor into reverse to lessen the approach speed—the boat should come to the stop position almost touching the landing
- before the reverse thrust has time to move the boat astern, select forward gear and open the throttle slowly to allow the boat to rest on the landing
- use the propeller as forward thrust, and compensate for wind and drift, which should enable the boat to remain in that position until the task is completed
- reverse clear of the landing when the task is completed.

6.9 Ropework

Ropes are used in FRBs to secure boats to jetties, shores and other boats, and to tow other boats and join ropes. It is important to only use the cleats and bollards as primary fastening points, as the rope will not bind during loading.

6.9.1 Knots

The following knots are some of the knots that can be useful when bollards and cleats are unavailable or are not suitable.

Bowline: use a bowline knot for tying eyes in the ends of ropes, which can then be used to secure the vessel, or on the end of tow lines.

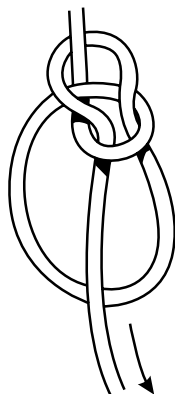

Figure 6:15

Bowline

Sheet bend: sheet bend knots are used to join ropes together.

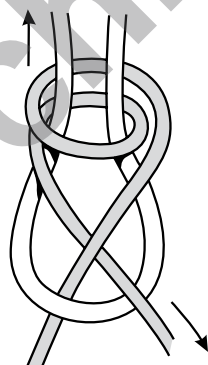

Figure 6:16

Double sheet bend

Round turn and two half-hitches: use these knots when tying to rails.

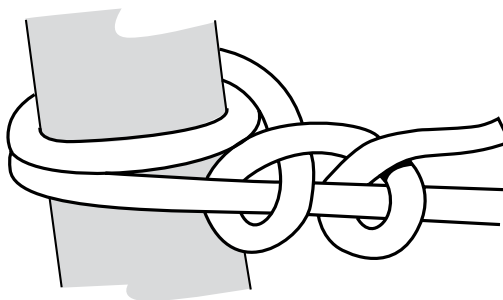

Figure 6:17

Round turn and two half-hitches

Clove hitch: a clove hitch is used for tying fenders to rails.

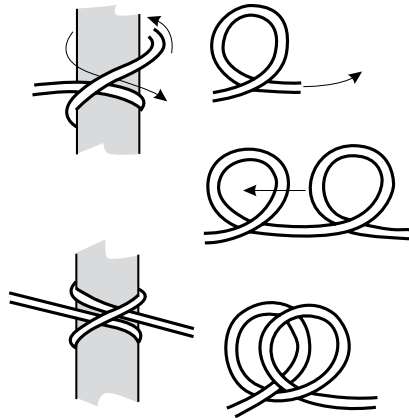

Figure 6:18
Clove hitch

Timber hitch: a timber hitch is useful for securing boats to trees and poles on the shore.

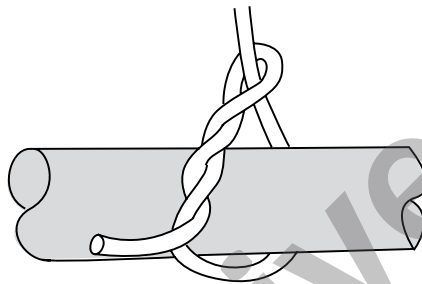

Figure 6:19
Timber hitch

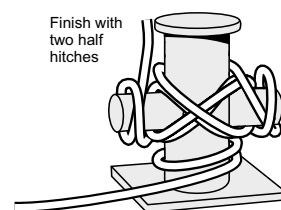
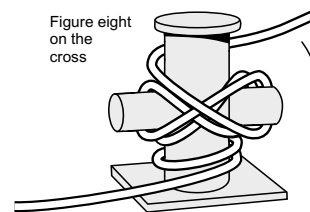
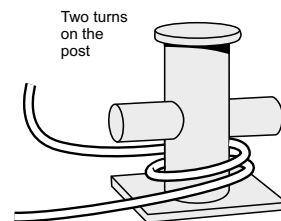
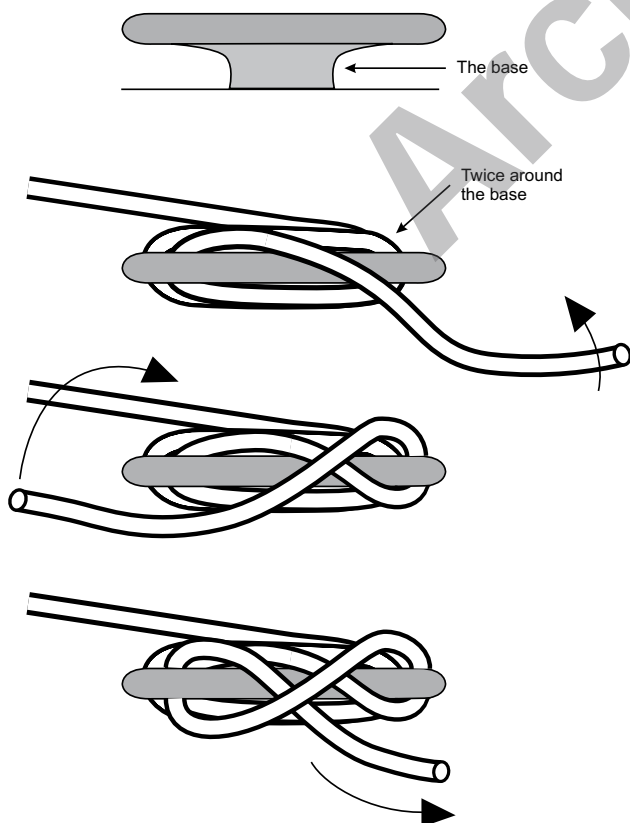

Figure 6:20
Tying off cleats and bollards

Details of rope construction, care and maintenance, and various knots are provided in the Australian Emergency Manual *General and Disaster Rescue*.

6.9.2 Belaying

When a rope needs to be cast off while still under strain, it cannot be secured with a bend or a hitch, except perhaps a slipping one. It is therefore belayed to a fitting made for the purpose, such as a cleat or bollard. The action of belaying consists of taking sufficient turns round the fitting to hold the rope by friction existing between rope and fitting. A wet and slippery rope or bollard, or a smooth cleat and a well-worn rope, may require extra turns.

6.9.3 Belaying to a cleat or bollard

To belay a rope to a cleat or bollard:

- take initial turns as shown in Figures 6:21 and 6:22
- continue with figure-of-eight turns round the horn of the cleat or bollard as many times as required.

When the figure-of-eight turns are removed, the rope is ready for casting off at a moment's notice; therefore, the turns should not be completed with a half-hitch, which may jam them. Cleats are not suitable for belaying wire rope.

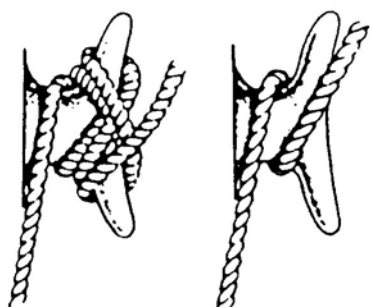

Figure 6:21
Belaying a rope to a cleat

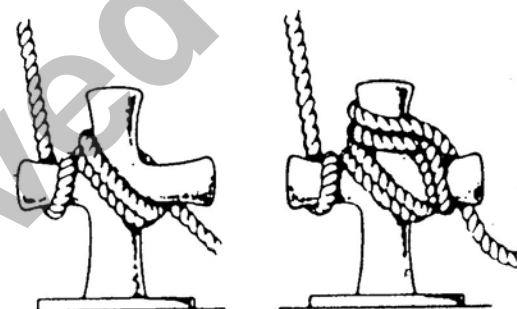

Figure 6:22
Belaying a rope to a bollard

6.9.4 Rope stowage

Whenever possible, rope should be stowed so as to keep the deck clear and the rope dry.

6.10 Anchoring

Anchors can be used to secure the FRB to a beach or river bank, or in midstream or at sea.

6.10.1 Dropping anchor

Crew members should follow these steps when laying an anchor (refer to Figure 6:23).

- First choose a spot carefully. Consider wind, depth of water under the keel, the tide, type of bottom and positions of other boats. Also ensure that State/Territory regulations and signage are complied with.
- Drive into the current/wind to where the boat is to be anchored.
- Lower the anchor and chain over the bow.
- Select reverse if needed and feed out the anchor line. Feed out three to four times the depth of water.
- Tie off and ensure the anchor is holding. Remember to check if there is enough swing space for current or wind change.

A dragging anchor can sometimes be felt bumping along the bottom by holding the rope lightly in the hand. In the event that the anchor does not grip and there is plenty of warp out, raise the anchor and try again.

A line buoyed to the crown of the anchor will permit it to be pulled up if it becomes fouled. This line should be long enough to prevent the buoy pulling the anchor should the water level rise.

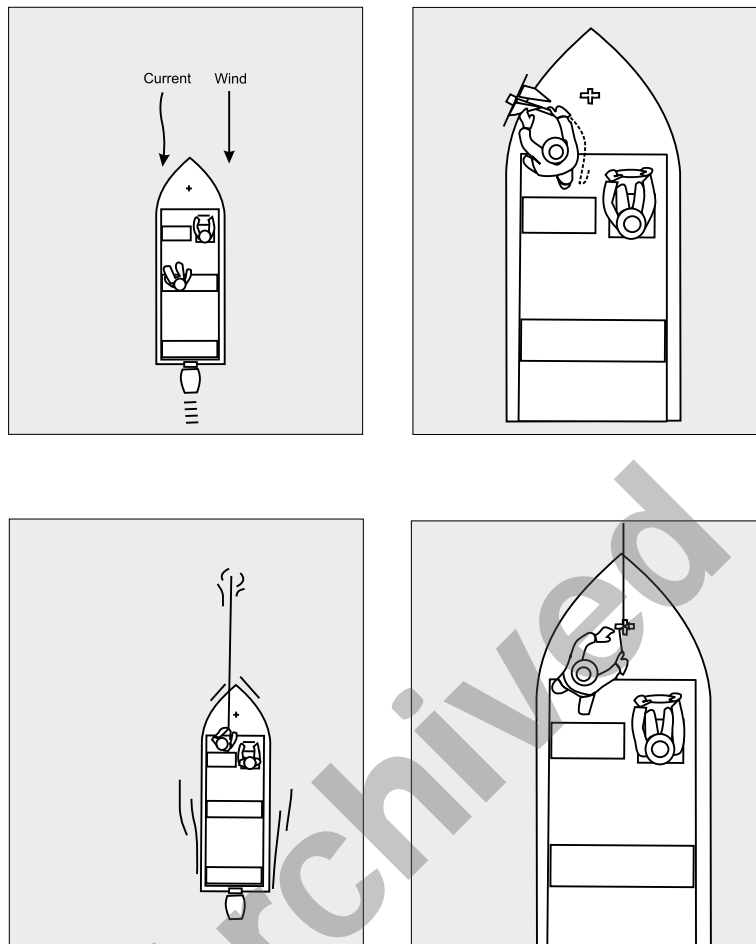

Figure 6:23
Laying an anchor

WARNING

Allow enough room for the boat to swing if the wind or current direction changes.

The tail of the anchor rope should always be tied to the boat.

6.10.2 Recovering an anchor

Use the following procedure when recovering an anchor:

- engage forward gear and drive forward slowly
- undo the anchor line from the bollard or cleat when the anchor line slackens
- drive the boat towards where the anchor is laid, and haul in the slack anchor line
- when the boat is over the anchor, stop and haul the anchor in and stow it.

Note: do not drive past the anchor, as the anchor line may be fouled in the propeller. If the anchor is fouled, tie the anchor line off to a strong bollard and drive the boat forward until the anchor comes free.

6.10.3 Danforth anchor

The Danforth anchor is the most common anchor found in FRBs. It is very effective on mud or sand bottoms but can be difficult to retrieve if it becomes wedged in rocks or trees.

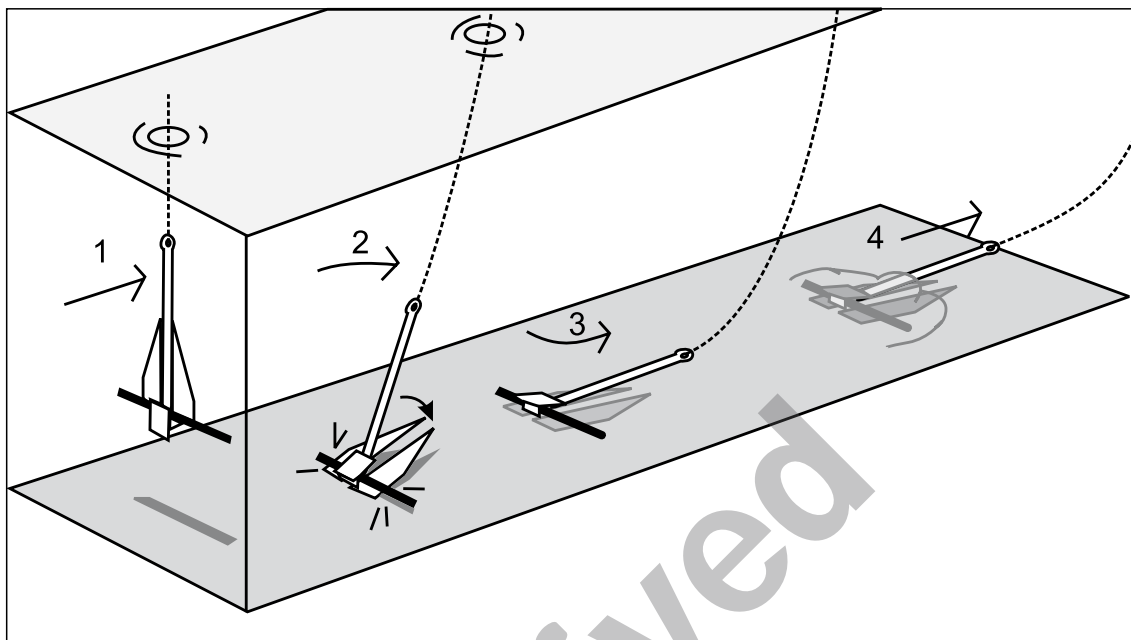

Figure 6:24
Danforth anchor

6.10.4 Grapple or reef anchor

Grapple or reef anchors are useful for rocky bottoms, where a Danforth anchor may not dig in.

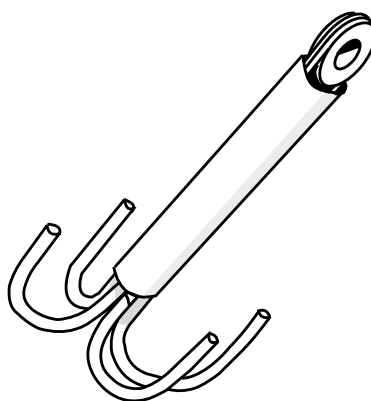

Figure 6:25
Grapple/reef anchor

6.10.5 Anchor warp

To ensure the anchor holds, let out the anchor line three or four times the depth of the water (eg if the water depth is 2 m, the anchor line should be paid out 6–8 m). In extreme cases, such as fast-flowing currents, up to eight times the depth could be required.

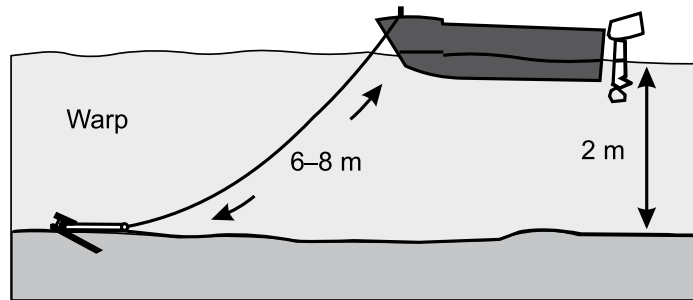

Figure 6:26
Anchor warp

6.11 Wind and waves

The surface of the water in rivers and dams can become very rough in windy conditions. Wind-driven waves are generally short and steep and come from the same direction as the wind. Driving into the wind, therefore, means driving into the waves.

Note: the further the wind travels over the water, the bigger the waves become.

6.11.1 Handling a head sea

When running into waves it is important to trim the motor in. This holds the bow down, reducing bow lift and pounding as the boat crosses the waves.

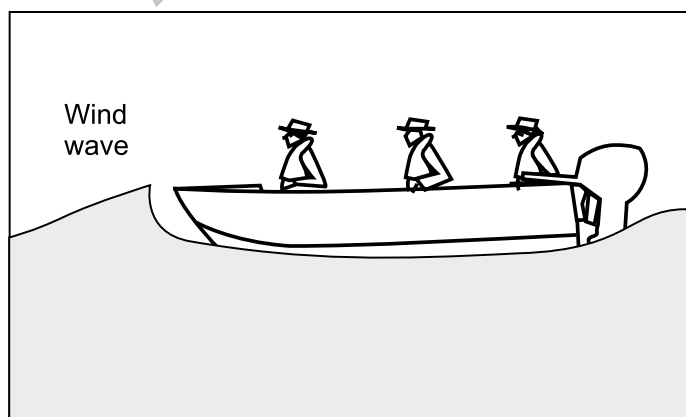

Figure 6:27
Head sea

If the waves are large, ease off the throttle as the boat reaches the crest of the wave so that the boat does not launch into the air behind the wave. Once on the back of the wave, accelerate to raise the bow till the trough is cleared.

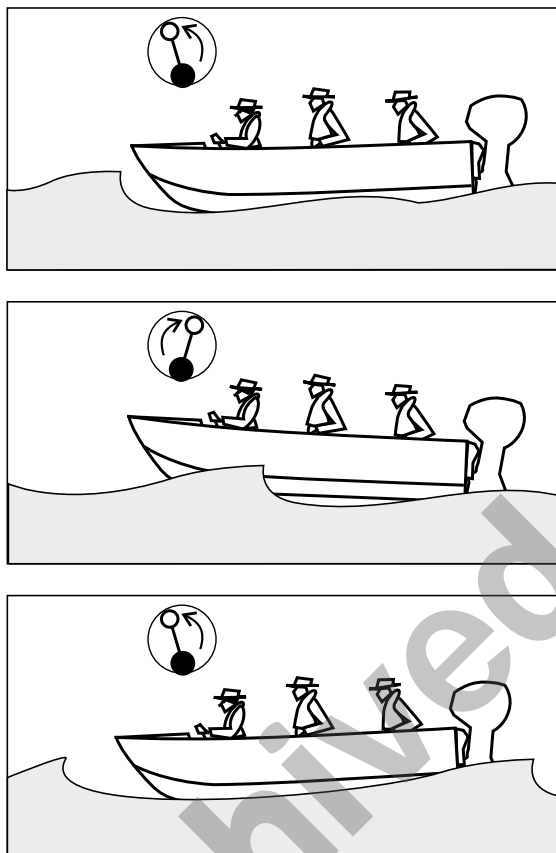

Figure 6:28

Handling a head sea

6.11.2 Handling a following sea

When running in the same direction as the wind and waves, it is important to trim the motor out. This lifts the bow and helps the boat clear the troughs. Driving in a following sea is usually comfortable with minimal pounding if the correct speed and trim are maintained.

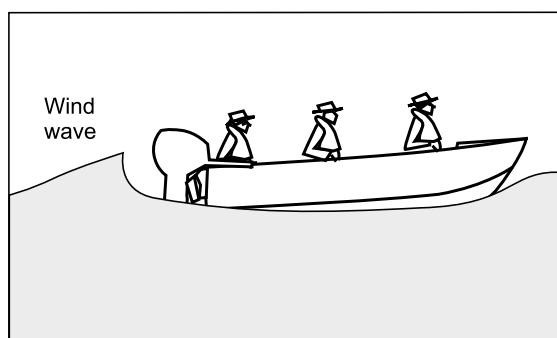

Figure 6:29

Following sea

If the waves are large, be careful not to go too fast, as the troughs between waves may be deep. When crossing the crest of the wave, keep the power on so the bow does not drop into the trough. The bow could punch into the next wave and swamp the boat.

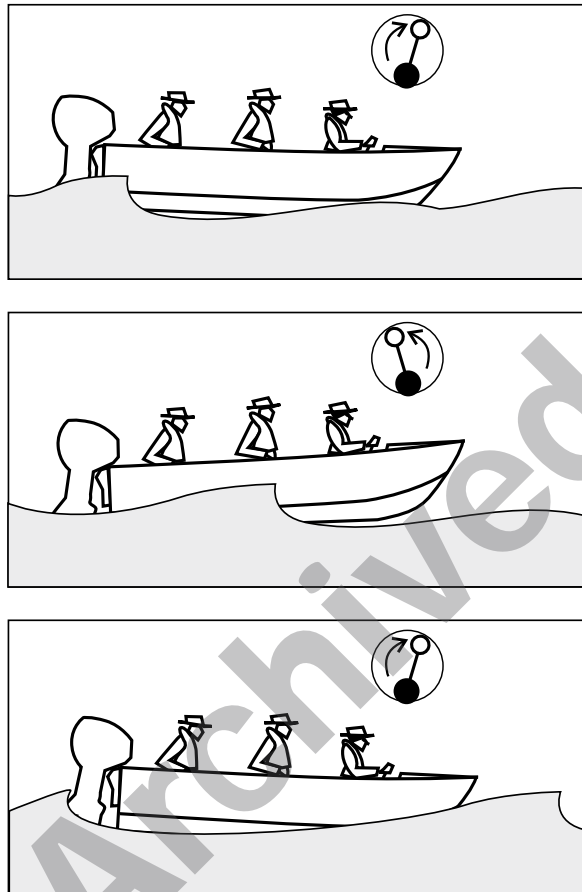

Figure 6:30
Handling a following sea

If waves are too big to cross, stay in between them and on the back of the front wave. If a big following wave catches the boat, the boat could be broached and rolled.

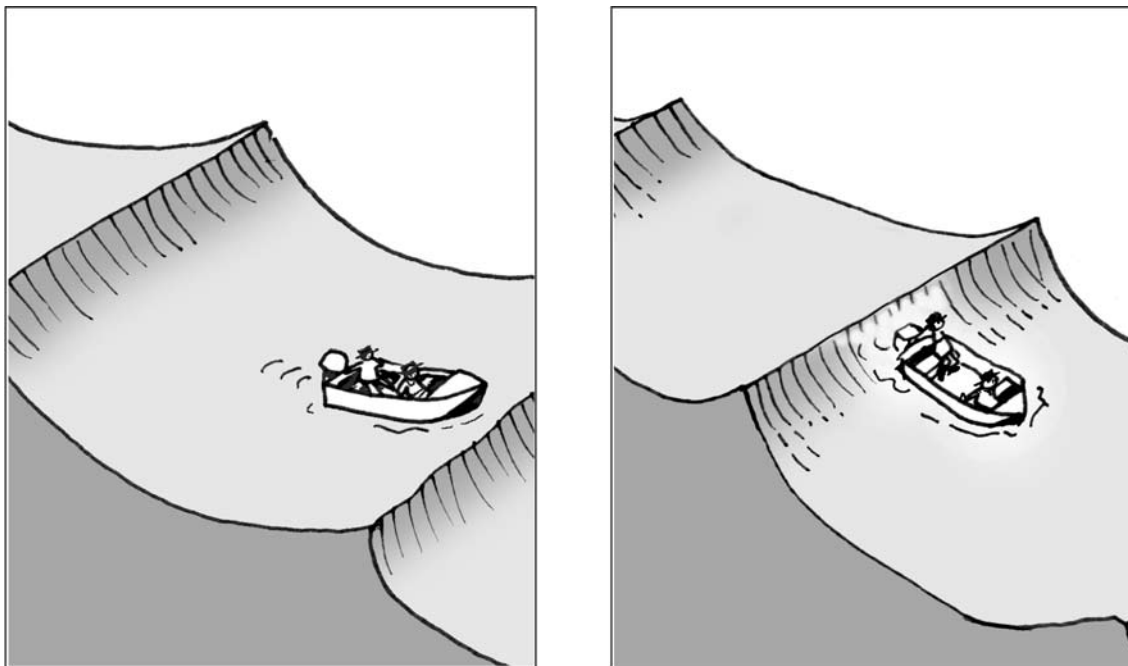

Figure 6:31a
Broaching

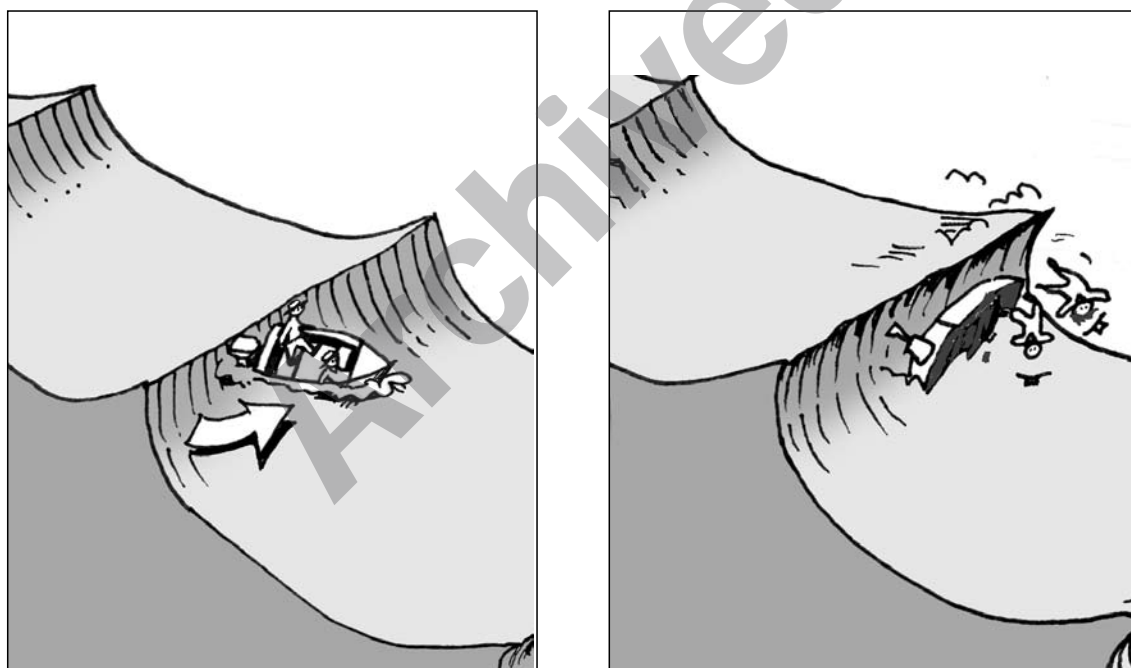

Figure 6:31b
Broaching

6.11.3 Boat wash/wake

Boats can also create waves. The wash/wake of a FRB can break windows and damage flooded buildings or levies and create hazards for other vessels. The best way to avoid creating destructive or dangerous wash is to reduce speed.

Archived

7.1 Rowing/paddling the FRB

FRBs carry oars or paddles in case the motor fails. To row or paddle a FRB:

- fit the rowlocks (if the FRB carries oars)
- place the oars in position or distribute the paddles to crew members
- trim the motor up
- commence rowing with a crew member on each paddle or oar.

To turn, row or paddle on one side only, dig the paddle or oar in on the inside of the turn.

7.2 Changing the propeller

A propeller can be easily damaged in flood or shallow-water operations. If the propeller damage is severe, the crew may have to change it to avoid engine or gearbox damage.

If possible, go to the safety of the shore, which allows crew members to change the propeller with no danger of the boat being washed downstream onto hazards or of crew members falling overboard or losing parts and tools overboard.

If it is not possible to get to the shore:

- anchor before trying to change the propeller
- hang a bucket under the propeller (this will help save any dropped parts from being lost in the water).

Use rope lanyards on tools so that they are not lost overboard.

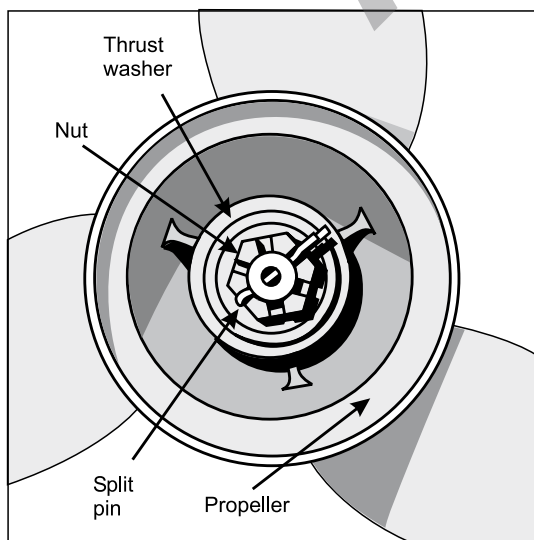

Figure 7:1
Propeller locking pin

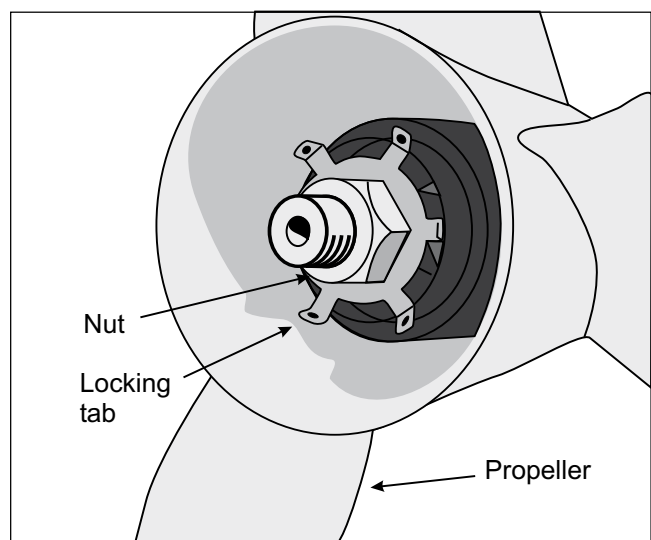

Figure 7:2
Mercury locking tab

7.3 Emergency stop drill

At times the coxswain needs to stop quickly to avoid hitting something. Use one of the following methods.

7.3.1 Broad side turn

Use a broad side turn when travelling at a fast speed and when there is some distance before the impending collision.

- a. Turn the boat hard in the clearest direction.
- b. Once at 90 degrees from the original direction of travel, quickly throttle back to neutral.

The hard turn creates water resistance, which will slow the boat quickly.

7.3.2 Reverse thrust

Only use the reverse thrust method when a collision is imminent and there is not enough time or space to do a broadside turn.

- a. Pull back the throttle to neutral.
- b. Allow the engine revs to drop back to as close to idle as possible.
- c. Select reverse gear.
- d. Throttle up to create as much reverse thrust as needed to stop the boat.

This method should only be used as a last resort, as going astern from forward while the motor is still revving high can stall the motor or damage the gearbox. It may also ship water over the transom, which may swamp the boat.

7.4 Throw lines

Ideally, a throw line consists of approximately 30 m of 10 mm cordage. Polypropylene is the most appropriate rope because it floats.

7.4.1 Throwing a line

Crew members must be able to heave a line to the shore, to a person in the water and/or to another boat. To throw a line:

- coil about two-thirds of the rope carefully in the non-throwing hand using small coils
- break the coil by taking about one-third of the line into the throwing hand (enough to reach the object to which the line is being thrown)
- throw the coiled rope in your throwing hand while firmly holding onto the rest of the rope—the rope must be allowed to run out freely from the coil in the non-throwing hand.

The end of the throw rope can be tied to a cleat on the boat so that it is not lost.

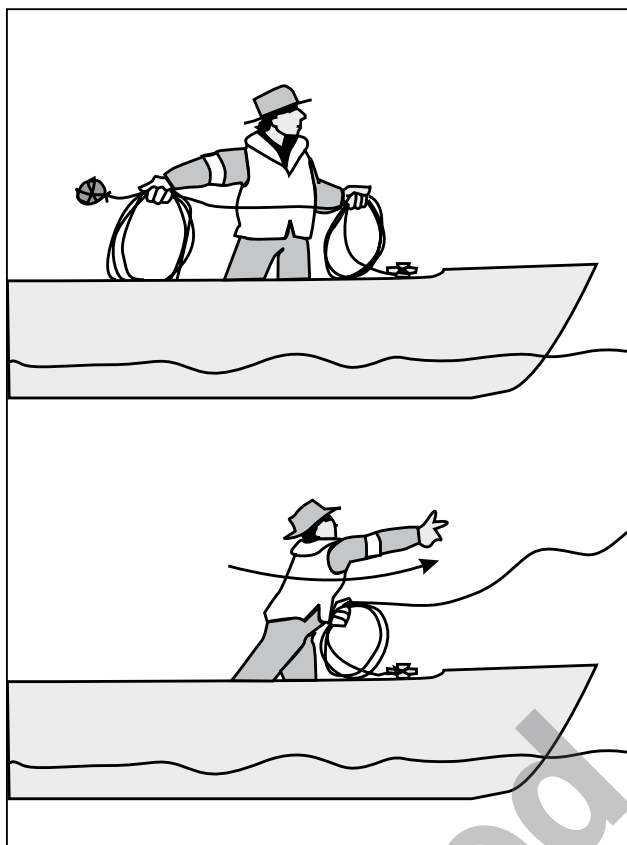

Figure 7:3
Throwing a line

7.4.2 Throwing a throw bag

A throw bag is the best method of getting a line to shore or to a person in the water. Throw bags are pre-packed and normally use a floating rope. To throw a throw bag:

- hold the end of the line or secure the line to a bollard
- grasp the bag's throw handle
- throw the bag using an underarm action.

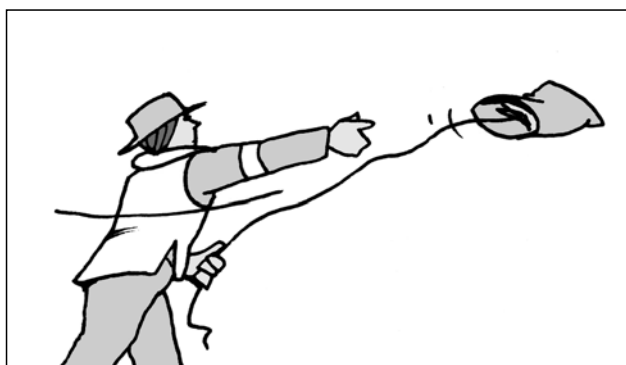

Figure 7:4
Throw bag

7.5 Defensive swimming

Crew members who fall into moving water may have to swim defensively.

- Float on your back with your feet downstream so your head is protected and you can see where you are going. This position also allows the swimmer to use hands and feet to fend off obstacles, and there is less chance of being trapped.
- Backstroke at an angle against the current to make your way to the shore or into a shoreline eddy.
- Do not try and stand until out of the main current and in shallow water.**

7.5.1 Holding a rescue rope

If a rescue rope is thrown to the swimmer, the swimmer should hold onto it as shown in Figure 7.5a. This keeps the head out of the water as the swimmer is pulled in.

Note: do not lie face down when holding the rope. Your head will be pulled under water.

DANGER

Do not tie the rope around yourself as you could be dragged under the water when you are hauled in. In strong currents, the force of the water will force you into the 'bottom first' position shown in Figure 7:5b and could drown you.

FRB crew members should not go into the water to rescue anyone. A crew member could become a victim and create two people to be rescued instead of one. The survivor could panic and drag the crew member under water, and either person could be swept away by currents. Stay in the boat and think about how to run a boat- or shore-based rescue.

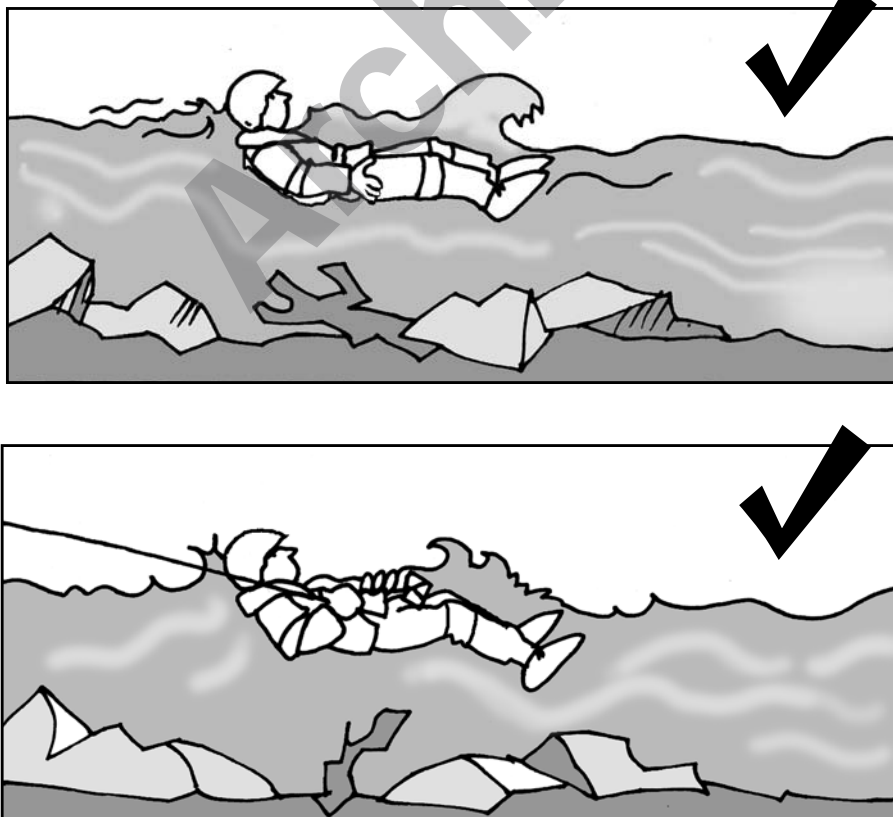

Figure 7:5a

Correct defensive swimming

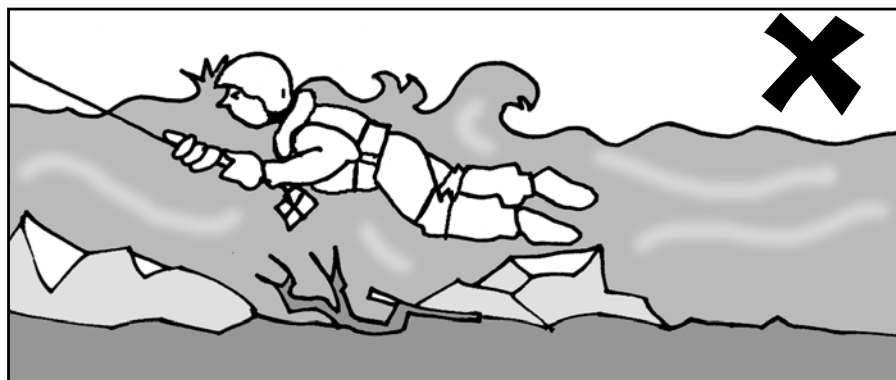

Figure 7:5b

Incorrect defensive swimming

7.5.2 Heat escape lessening position (HELP)

Anyone who ends up in the water and is likely to be there for a long time can become very cold. Use the heat escape lessening position (HELP) to reduce heat loss.

The diagram shows the HELP, used for one person in the water.

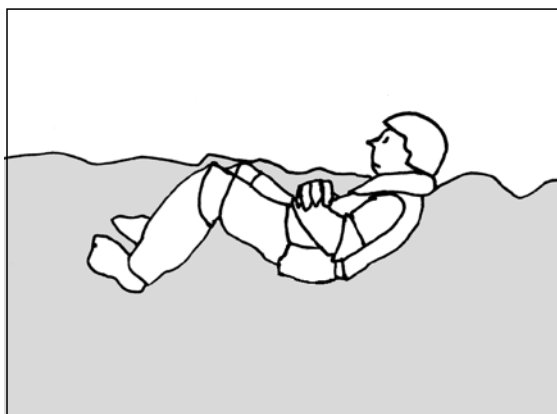

Figure 7:6

HELP position

7.5.3 Huddle

If more than one survivor is in the water, form the huddle position. Huddling in a group keeps each group member much warmer than being alone.

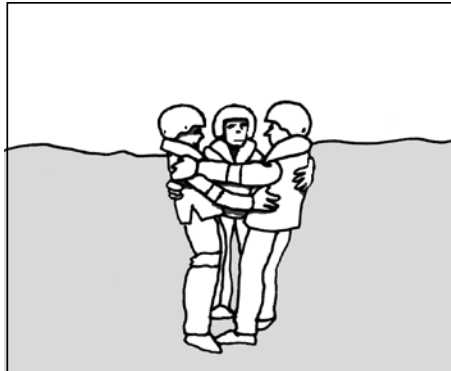

Figure 7:7
Huddle position

7.5.4 Advanced techniques

It is important that crew members do not panic if they end up in the water in standing waves or in the vicinity of vertical drops, low head dams and strainers (see Chapter 9: *Operating in Currents* for more information about strainers). Apply the same principles of basic defensive swimming, and stay aware of your position and what is happening so you can breathe and prepare yourself.

When travelling through standing waves it is important to:

- adopt the defensive swimming position
- relax and hold your breath when passing through the wave
- when high on the back of the wave observe what is ahead
- breathe while in the wave troughs.

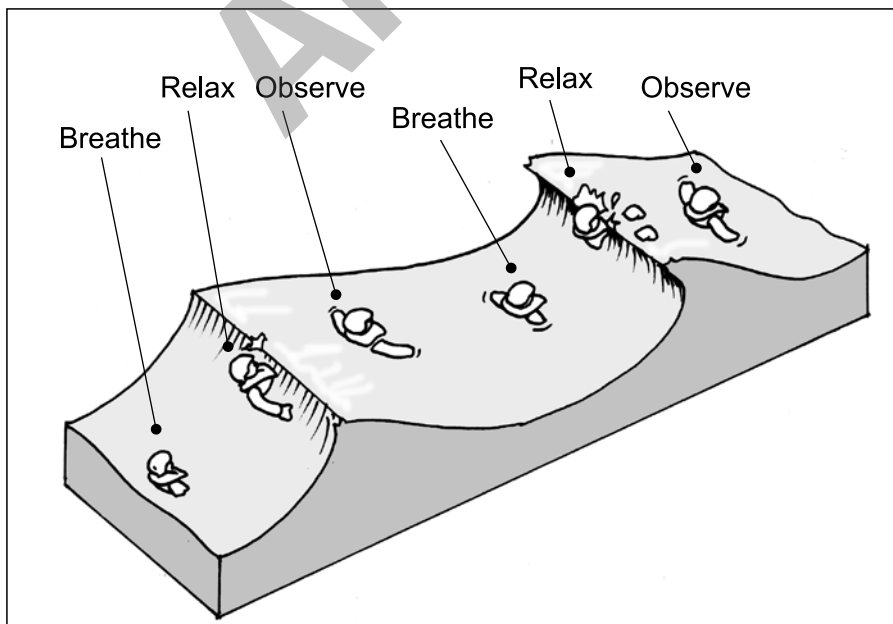

Figure 7:8
Swimming/standing waves

If taken over a vertical drop:

- relax and breathe as much as possible before the drop
- pull up your knees to avoid being trapped
- swim downstream after surfacing in the boil line or try and catch the underwater current.

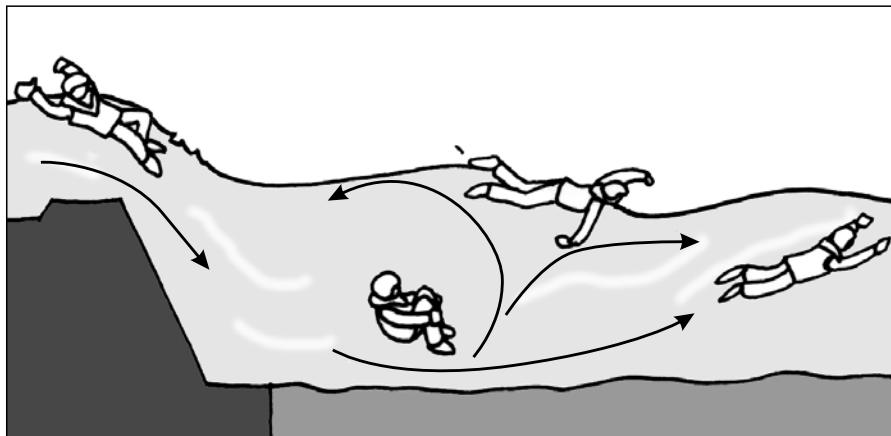

Figure 7:9
Vertical drops

Crossing strainers is very dangerous and should be avoided if possible, as the force of the water could pin the swimmer's body in the strainer. A swimmer who encounters a strainer should swim towards it head first, then push up and over it.



Figure 7:10
Crossing strainers

7.6 Recovering survivors from the water

Before approaching a survivor in the water, consider:

- the current
- wind and waves
- the available gear
- if the survivor is able to climb into the boat by him/herself
- the kind and extent of the survivor's injuries.

Currents and winds make manoeuvring boats around people in the water difficult and sometimes dangerous. Use the **stop and take 5** rule (see section 3.11.3).

Consider the options:

- can a line be thrown and the survivor hauled into the boat?
- can the survivor be towed to a place of safety?

Tell the survivor to keep his or her legs from under the FRB and to avoid submerged objects.

Wherever possible, a person should be recovered from the water over the side or stern. If the casualty must be taken aboard over the side of the boat, special care must be taken to maintain the balance of the boat. Due to the possibility of swamping or capsizing the boat, never rock the boat to bring the casualty aboard. When recovery is over the stern, the motor must be stopped, not merely out of gear.

WARNING

Always be aware that the survivor could be hit by the boat or propeller. Remember that the boat steers by the stern. If needed, to get away from the survivor, concentrate on swinging the propeller away from the survivor, not steering away from them. The bow may need to be steered towards the person to get the stern to swing away.

7.6.1 Leg-over method

The leg-over method works best where there are limited crew members to help and the person in the water is fit, agile and able to help. If needed, the coxswain can move the boat slowly to safety while the survivor is hanging onto the side. To use the leg over method:

- move the boat alongside the person
- tell the person what is happening
- tell the person to hang onto the gunwale with hands or elbows forward of the middle of the boat
- get the person to swing one leg over the gunwale
- grab the person's clothing near the waist and help to roll the survivor over the gunwale and into the boat.



Figure 7:11

Leg-over method

7.6.2 Head-first method

The head-first method is recommended when the survivor is limited in the ability to help. To pull a person head first into the boat **at least** two crew members are needed. Pull a person in face down so that the person bends forward and does not scrape his or her spine along the gunwale. The person can also use his or her hands to help fend off the gunwale and help the crew if possible.

To use the head-first method:

- move the boat alongside the person
- position the person amidships, facing into the boat
- put one crew member either side of the person
- each crew member should grab the person under the armpits with one hand and around the waist area (belt, pants, pockets, PFD) and pull the person in.

Where possible, talk to survivors before grabbing them and be careful not to hurt them while lifting them in.

Creativity may be needed in some situations to get a person into the boat. Crew members should ask themselves:

- is it safe?
- will it work?

Did you know?

Tipping the gunwale closer to the waterline makes it easier to lift a survivor into the boat. The crew leader needs to be aware of the boat's stability and coordinate the crew while this is happening. Do not roll the gunwale under water or the boat may be swamped or capsize.

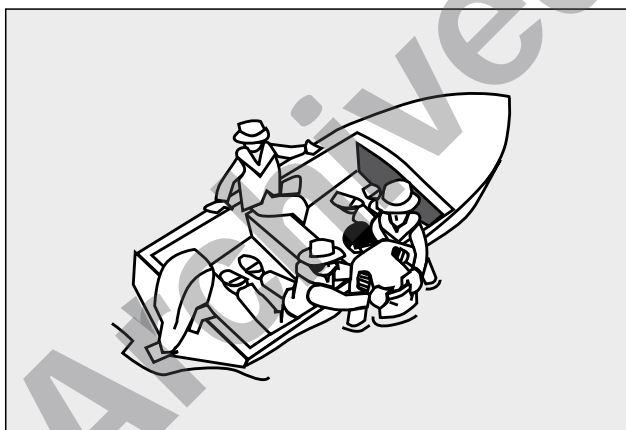

Figure 7:12

Head-first method

7.6.3 Feet-first method

The feet-first method works well in small boats with low gunwales and inflatable-sided boats. To use the feet-first method:

- move the boat alongside the person
- position the person perpendicular and feet first to the side of the boat
- grab the person's legs and pull the person towards the boat until his or her knees are on the gunwale
- grab the person's hands and haul the person up until he or she is standing in the boat.

It is important to brief the person as a person's head may dip into the water when his or her feet are grabbed.

Ensure the person is briefed not to try and help as he or she is stood into the boat.

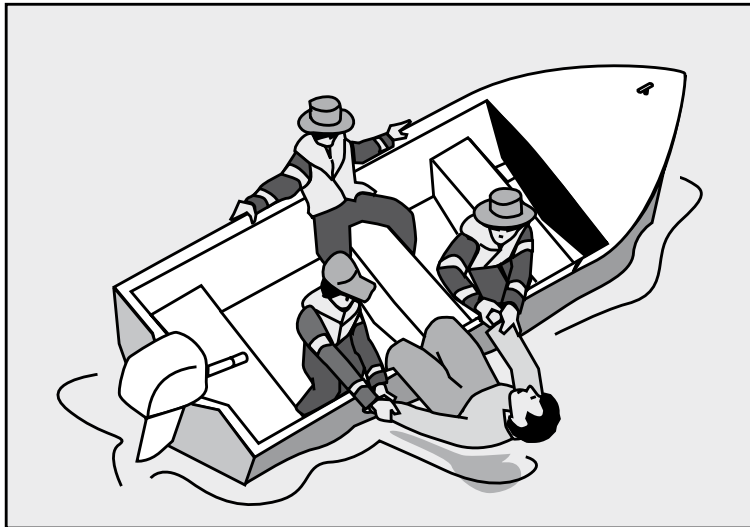

Figure 7:13
Feet-first method

7.6.4 Recovery over the stern

The recovery over-the-stern method makes it very easy for a fit and agile person to get into the boat. **Do not** use this method if the boat may need to be moved away from a hazard during the rescue. To use this method:

- move the boat alongside the person
- have the person grab the gunwale amidships
- switch the motor off or at least check it is in neutral
- get the person to move along the gunwale to the transom
- tell the person to put a foot onto the cavitation plate, one hand on the motor and one hand on the transom
- tell the person to step up and into the boat while helping the person as needed, or use a stern step or ladder if one is fitted.

Tip: on tiller steer boats get the person to enter over the transom on the opposite side of the outboard gear selector. This avoids accidental engaging of gears, which could be very dangerous if the engine is running.

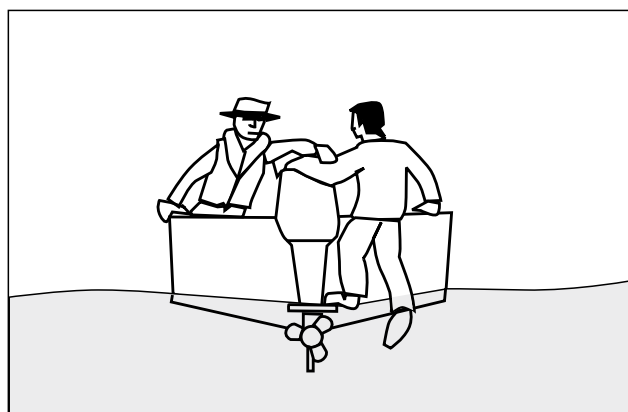

Figure 7:14
Over-the-stern method

7.6.5 Basket stretchers

To recover a casualty from the water using a basket stretcher:

- If the stretcher has not been made buoyant with flotation devices, attach a PFD to the foot end of the stretcher
- manoeuvre the FRB alongside the casualty
- position the stretcher under the casualty
- float the foot end of the stretcher, with the casualty inside, around so that it is 90 degrees to the boat, with the stretcher head closest to the boat
- manoeuvre the stretcher across the gunwale and then down into the boat, taking care of the casualty's injuries.

7.6.6 Recovery boards

A range of commercially made spinal boards specifically designed for water use are available. An alternative is to construct one using 20 mm marine ply. The method of rescue is as follows:

- position the board halfway out over the gunwale at 90 degrees to the boat, and angled into the water
- position the casualty's back onto the board
- use two crew members to grasp the casualty under the armpits (if the injuries allow it) and haul the person up onto the board as gently as possible
- at the same time, pivot the board up to a horizontal position on the gunwale
- lift the board and casualty on board the boat.

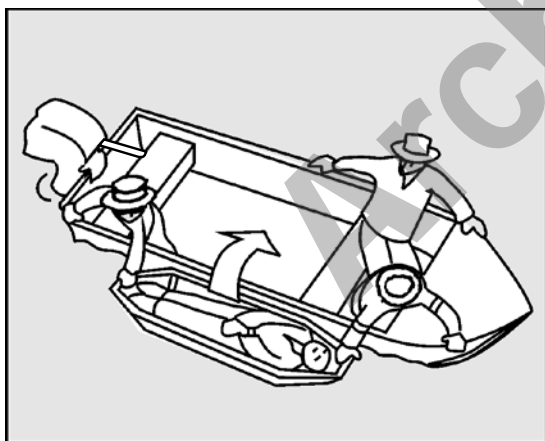

Figure 7:15
Backboard/stretcher recovery

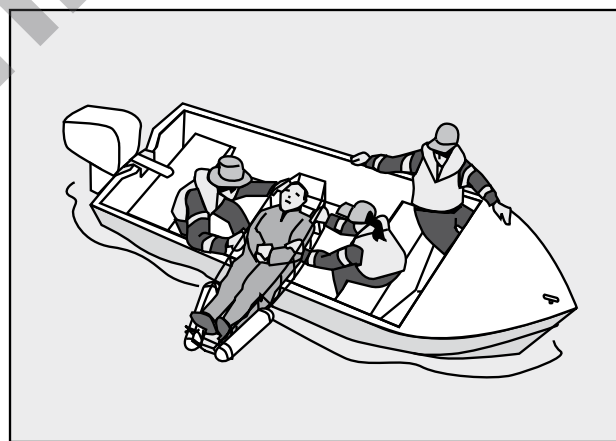

Figure 7:16
Stretcher recovery

7.6.7 Combination method

One of the best methods of recovering a casualty from the water is to combine the recovery board and the basket stretcher. Once the casualty is in the stretcher, the board can be positioned and balanced across the gunwale. The stretcher is then slid up the board and pivoted into the boat. All of these methods require practice.

If equipment is not available, or the casualty's injuries prevent its use, the casualty may have to be towed ashore after securing the person with a PFD and lines.

Note: never attempt to lift people over the side on their backs, as this may cause severe injuries.

7.7 Overboard drill

If a person falls overboard:

- shout 'OVERBOARD PORT/STARBOARD SIDE' and point to the person in the water
- if possible, throw a flotation device to the person
- keep visual contact with the person in the water and keep pointing at the person
- turn the FRB around and approach the person from downstream, if possible
- recover the person.

7.8 Capsize drill

If the FRB capsizes:

- make sure no one is trapped under the boat and ensure everyone is okay
- stay with the boat, as the boat has built-in buoyancy and will keep floating, and it is easier to spot for rescue
- climb onto the upturned hull if possible
- if it is not possible to climb onto the upturned hull, stay on the upstream side to avoid getting trapped between the boat and things like bridges and trees.

7.8.1 Boat righting

Small boats can often be righted; however, **stop and take 5**. If the situation is too dangerous, it may be safer to just stay with the upturned boat or try to reach shore. Crew members should use the following techniques:

- a. Stand on the downwind gunwale and grab hold of the keel.
- b. Lean back and push the gunwale down while pulling the keel towards you. This will roll the boat upright. As the upwind gunwale comes out of the water, the wind will help to roll the boat over.
- c. When the boat is upright, position a crew member at each end of the boat and turn the bow into the wind and waves.
- d. Hold the boat stable and start bailing
- e. When it is buoyant enough, put one crew member into the boat to continue bailing. The crew member should stay low and central because the boat will be unstable and may roll again.
- f. As the boat becomes more stable, other crew members can get in to help.
- g. If possible find the oars/paddles and get to the nearest bank.

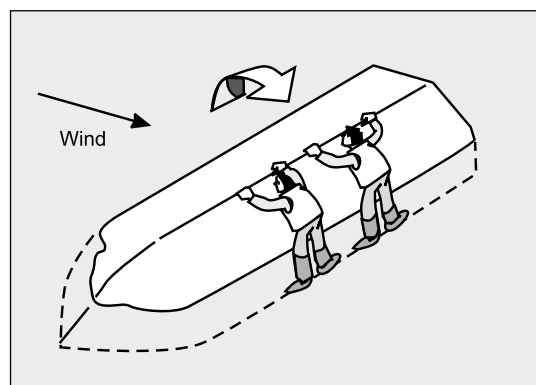

Figure 7:17
Boat righting

7.9 Fire drill

In the event of fire, if possible:

- steer the boat to keep the fire downwind of the crew
- cut off or isolate the fuel tanks and, if necessary, throw them overboard
- fight the fire
- if it is too dangerous to stay in the boat, abandon the boat.

Remember: do not try to save the boat while risking the crew's safety.

7.10 Distress calls

There are two methods of transmitting an emergency on the radio.

7.10.1 Mayday call

Mayday is a request for immediate assistance in an imminent, life-threatening emergency. If crew members hear a Mayday call, they should listen but not transmit. Crews should determine if they are in a position to help. If not, maintain radio silence.

Use the following procedure to make a mayday call:

- a. Call 'MAYDAY, MAYDAY, MAYDAY!'
- b. Call 'THIS IS (NAME OR CALLSIGN OF BOAT)' three times.
- c. Repeat once more: 'MAYDAY (NAME OF BOAT)'.
- d. Now report your position and give as accurate a position as possible.
- e. Report the nature of the emergency.
- f. Report the kind of assistance desired.
- g. Report the number of people on board and the condition of any injured.
- h. Report a description of the boat and seaworthiness.

7.10.2 PAN PAN message

PAN PAN is an urgency message that indicates a boat or person is in trouble but not in immediate danger. Follow the same procedure as a mayday call.

7.11 Distress signals

If a FRB is in distress, a number of visual signals may be made to indicate that assistance is required. The signals are in two main categories:

- **'V' sheet**—regardless of the area of operation, all FRBs are advised to carry a 'V' sheet, which is an internationally recognised distress signal. If the boat is disabled, the 'V' sheet may be displayed by tying it to the deck to be observed from the air or by displaying it vertically to be observed from the shore.
- **internationally recognised signals**—for example distress flares.

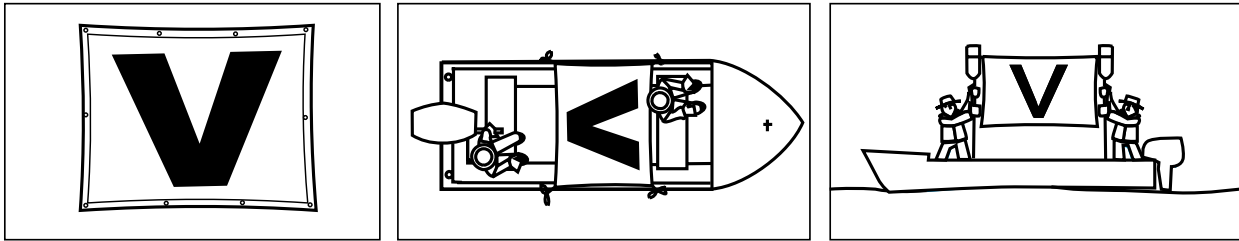

Figure 7:18

'V' sheet

Distress messages can also be conveyed by satellite telephones and mobile telephones carried by crew members.

Vessels may also carry flares, smoke flares, dye markers, EPIRBs and signalling mirrors.

7.12 Abandoning the FRB

Before abandoning the FRB for any reason, crew members should try to ensure:

- everyone is wearing a PFD
- a radio mayday distress message has been sent.

When a decision is made to abandon the FRB, crew members should also try to ensure that everyone lowers themselves into the water safely.

Remember: do not abandon a FRB in distress until absolutely necessary. A swamped or capsized FRB is easier to locate than a person alone in the water.

7.13 Loading and unloading

It is very important to maintain the stability and trim of the FRB when loading and unloading. This keeps the load low and evenly distributed. Too much weight on one side or a shifting load may cause the boat to turn over.

Different FRBs behave differently when loaded. It is important to know how much a boat can carry safely and how to load the FRB (check the compliance plate). Crew members should test the FRB loaded so they know how it handles. Operating conditions can affect how much can be carried. For example, in fast-flowing water with many hazards the boat will be able to carry much less than in a large expanse of slow-moving water because the conditions will demand a good power-to-weight ratio.

Tips:

- newer boats have compliance plates that show the maximum load recommendation—use this as a guide
- keep the load as close as possible to the centre line and as low as possible in the vessel.

When loading the FRB crew members should consider:

- the conditions
- the power-to-weight ratio
- changing to a lower pitch propeller
- the need to tie down the load—a shifting load may capsize the FRB
- the right FRB for the operation
- the need to keep the load low to avoid obscuring the coxswain's vision
- carrying minimum crew to keep the boat as light as possible.

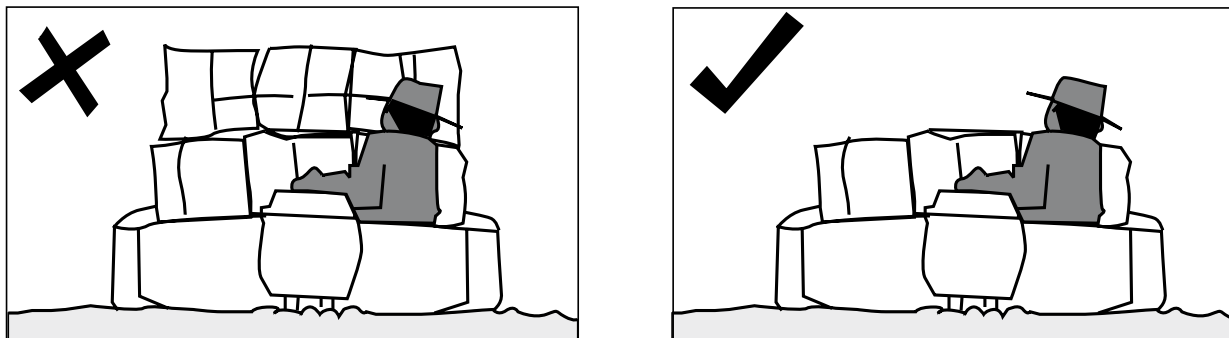

Figure 7:19
Loading a FRB

7.13.1 Boat to boat

If a load needs to be transferred from FRB to FRB, be careful to maintain the stability of both vessels. Consider:

- transferring the load while on a bank
- current and debris
- barge-tying the boats together
- anchoring.

7.14 Moving people and animals

FRBs are often used to assist other agencies, including:

- **police**—to carry officers to a crime scene or to search for a missing person
- **ambulance**—to pick up an elderly patient from an isolated farm
- **Roads and Traffic Authority**—to inspect a bridge approach before reopening a road.

REMEMBER

The person in command of the FRB is the technical expert in charge of the boat. Take into account the requests of other services when making decisions but be aware that the person in command is accountable for the safety of the boat, crew and anyone or anything in it.

7.14.1 Capacity stickers and compliance plates

A capacity sticker or compliance plate must be displayed clearly on all FRBs. Ensure the FRB has one. If it does not, check with the local legislative authority.

These stickers/plates show the maximum number of people, or maximum load, to be carried in the boat.

WARNING

The legal capacity of the boat must not be exceeded unless it is an emergency where not acting may cause loss of life (ie urgent flood evacuation). Even in these situations the crew must stop and take 5 before acting.

VESSEL CAPACITY PLATE - POWER BOATS LESS THAN 6 METRES

This capacity plate is issued by the Waterways Authority for the guidance of boat owners. The table below shows the maximum persons capacity of all power boats less than 6 metres in length. The number of persons and maximum permissible total weight per vessel is calculated in accordance with Australian Standard AS 1799.1- 1992. Alternatively owners may determine the maximum persons capacity of their vessel as that laid down by manufacturer of the vessel or by any other method approved in writing by the Authority.

MAXIMUM CAPACITY
 **PERSONS**
 IN CALM WATERS ONLY

Length of vessel (m)	Maximum number of persons	Maximum permissible total wt. (kg)
up to 3m	2	180
3m to 3.5m	3	270
3.5 to 4.5m	4	360
4.5 to 5m	5	450
5m to 5.5m	6	540
5.5m to 6m	7	630

Please determine your vessel's capacity and fix the number in the space above.

Warning
 1. This is the maximum persons capacity for GOOD conditions. A reduction in maximum number MUST be made in adverse weather conditions or when on the open sea.
 2 Capacity is assessed at 75kg per person (with an additional allowance of 15kg per person for personal gear). A child up to one year of age does not count. Each child over one year and under 12 years equals one half of an adult.

Waterways
 We're with you on the water

1 2 3 4 5 6 7 8 9

Use one or two numbers in the space above to show your boat's capacity.

Figure 7:20
Capacity stickers

7.14.2 Evacuations

Evacuations happen in a variety of situations (eg from isolated land, buildings, floating objects and even other vessels). The amount of personal possessions that evacuees can take with them may need to be limited.

Crew members should ensure that:

- the FRB is never overloaded—it is preferable to do two trips than risk capsizing
- the details of evacuees (including name, date of birth and address) are written in the crew leader's notebook and passed on to the local unit
- passengers always wear PFDs. If there is a problem fitting a PFD to a person (eg an immobilised casualty or a very large person), **stop and take 5** (eg ask what is the risk of losing the casualty overboard versus the risk of delay versus other options of evacuation, such as by helicopter?).

7.14.3 Passengers

When passengers are being carried they should be seated and briefed, just as in an aeroplane. The brief should include:

- who is in charge of the boat
- the need to follow directions from crew members at all times
- instructions to fit a PFD
- what to do in an emergency.

Remember: passengers may have no idea of vessel stability. Crew members need to be in control of the passengers' movements about the boat, especially when loading and unloading.

7.14.4 Evacuating the injured

It may be necessary to evacuate or transport casualties (eg from flooded hospitals or damaged and isolated locations), and it is preferred that all crew members are qualified in first aid. If the injuries are severe or life threatening it may be necessary to have a doctor, paramedic or nurse to give assistance or even to travel onboard with the patient.

The following points may assist with the loading and transport of casualties from ashore:

- secure the boat correctly and as close as possible to the casualty
- blanket and lash in stretcher cases, if necessary, for the land transportation phase
- unlash the casualty **before** attempting to load the stretcher onto the FRB, and fit a PFD if the injuries allow it; if the stretcher is dropped, the casualty may drown due to being tied in
- **do not** lash the casualty into the stretcher until safely transported onto land; make sure the casualty is blanketed and reassured during the trip
- the stretcher itself may be secured to the FRB to maintain trim and stability
- if required, radio the casualty's condition and the boat's destination for transfer to an ambulance as soon as possible.

7.14.5 Looting

Crews may witness looting of properties during FRB operations, particularly after evacuation of towns and cities. If possible, report details to the operations centre as soon as possible but do not attempt to apprehend the perpetrators: this is the job of law enforcement agencies.

7.14.6 Transporting animals

During evacuation it may be possible to also transport the pets of those affected, particularly if it means the difference between the person leaving a dangerous location or staying; many people will not leave without their pets. Some small animals can be carried inside the boat if safe to do so (ie the animal is secured, under the control of the owner and is not dangerous to the crew).

Larger animals may need to be towed and guided to safety with a halter line—almost all animals can swim very well. Crew members should use the following procedure to assist with this process:

- use a halter line around the animal's neck—one that is long enough to keep the animal well away from the propeller
- secure the line around a cleat rather than holding it by hand, but secure it so as to allow for a quick release
- keep the boat away from the animal, as it may panic and try to board.

WARNING

Do not attempt any method of carrying unrestrained animals in a boat.

7.15 Moving large livestock

A single animal such as a horse or cow may be moved by the above method. However, FRBs can also herd large numbers of stock in much the same way as dogs. This operation should only be carried out if the animals are in extreme danger or distress where they are, and where the distance to safety is not excessive. The following points may assist with moving stock in flooded areas.

7.15.1 Taking the call

When a call is received from a property to assist with moving stock, record the following information:

- name and location of the property
- name and availability of the property/stock owner
- directions to the property if not located on main roads
- contact details of the caller and/or the property
- number and type of stock to be moved, if known
- current river and flood conditions
- is it possible to get to the property by road?
- if known, the closest/best launch point to where the stock are stranded.

7.15.2 Equipment required

The following equipment will assist with moving stranded stock:

- tools such as pliers, bolt cutters, axe, knife, shifting spanner
- coil of 4 mm rope and two lengths of 16 mm rope approximately 10 m long
- a dozen plastic bags or rags
- eight to ten long star pickets
- handheld radios for communication between the boat crew and shore-based personnel.

The number of crew members will depend upon who is available, but at least three will be required—one to stay with the vehicles, one in the boat, and one to work on land with the stranded stock.

Upon arrival at the property, speak with the owner or manager if possible. It is also a good idea to take the owner or manager along to the location of the stranded stock because they will know the terrain, the hazards and even the temperament of the stock. If the property has working dogs, it may be worthwhile taking them to assist. Dogs should **not** be used if calves or foals are involved.

While dairy cattle are accustomed to being handled, beef cattle and horses may be less manageable and unpredictable. Bulls should **never** be trusted, no matter how quiet they appear; always carry a stick or length of poly pipe when working stock and use the owner's knowledge whenever possible.

7.15.3 Moving the stock

The following steps describe a simple and effective method of swimming cattle from a threatened location to dry land. Not all situations will be the same and each will require a careful assessment, preferably in consultation with the property owner. The diagrams are used as examples only.

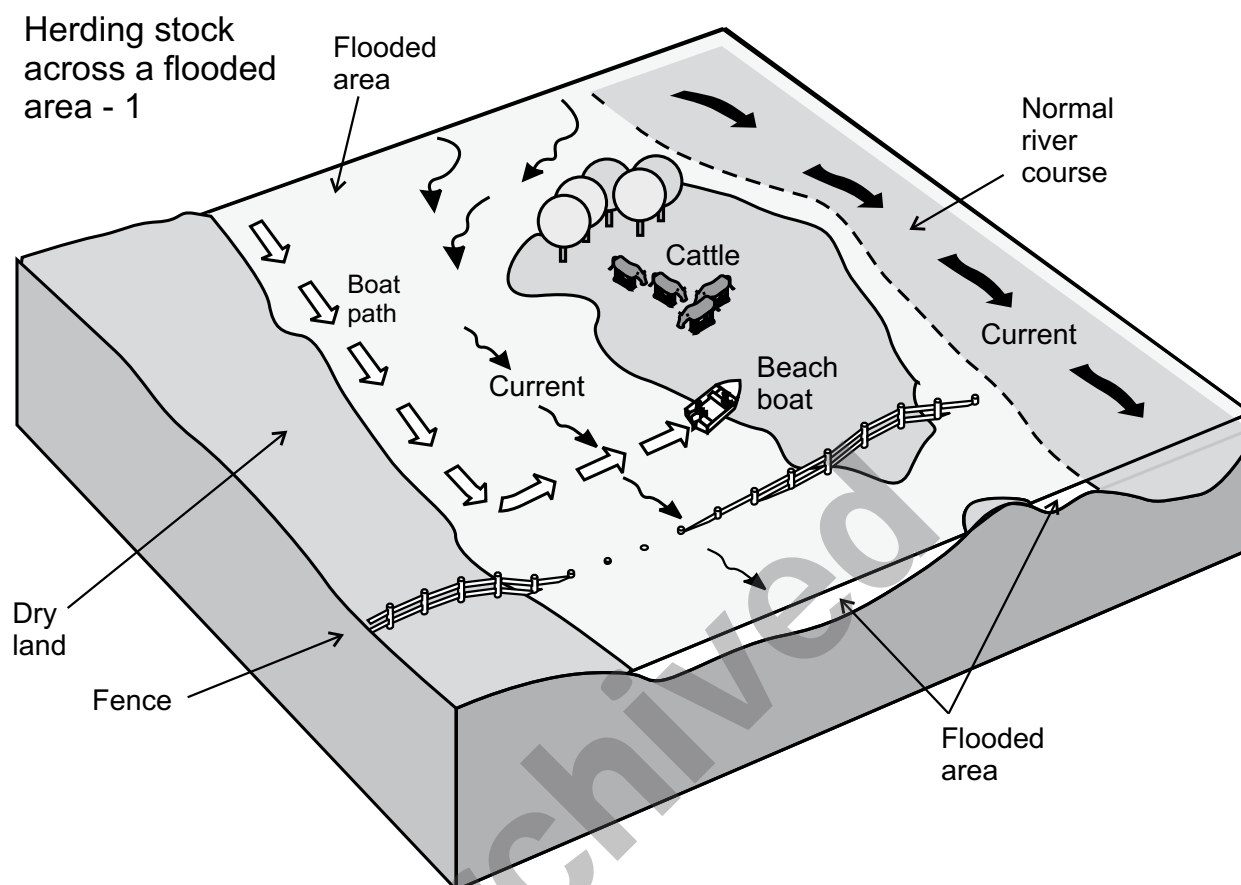

Figure 7:21a
Swimming stock

- a. Assess the situation carefully, noting the direction and strength of flow, location of fences, thick timber and other landmarks.
- b. Check out the intended route and probable landing spots the stock will be using; it is no use making cattle swim across flooded terrain if they cannot climb up steep cliffs on the other side. Depending on the strength of the current, allow 300–400 m for stock to drift downstream.
- c. Land some crew members in a location where they can assist with herding the stock; the property owner should stay with the boat to assist the person in command.
- d. It is often difficult to get stock to move into the water. A wing, consisting of star pickets/posts, sticks, ropes, rags and existing material such as rocks and logs, can be constructed to act as a funnel from the land into the water. The distance the wing extends out into the water will depend on water depth, while the angle of the wing will depend on the current strength: the stronger the current, the more acute the angle. The wing is not designed to hold the stock but to guide them into the water.
- e. Once the stock begin to swim, the FRB can be positioned to keep them moving and prevent them from turning back. The boat should maintain a safe distance from the animals as they swim across, remembering that they will drift downstream.

Herding stock across a flooded area - 2

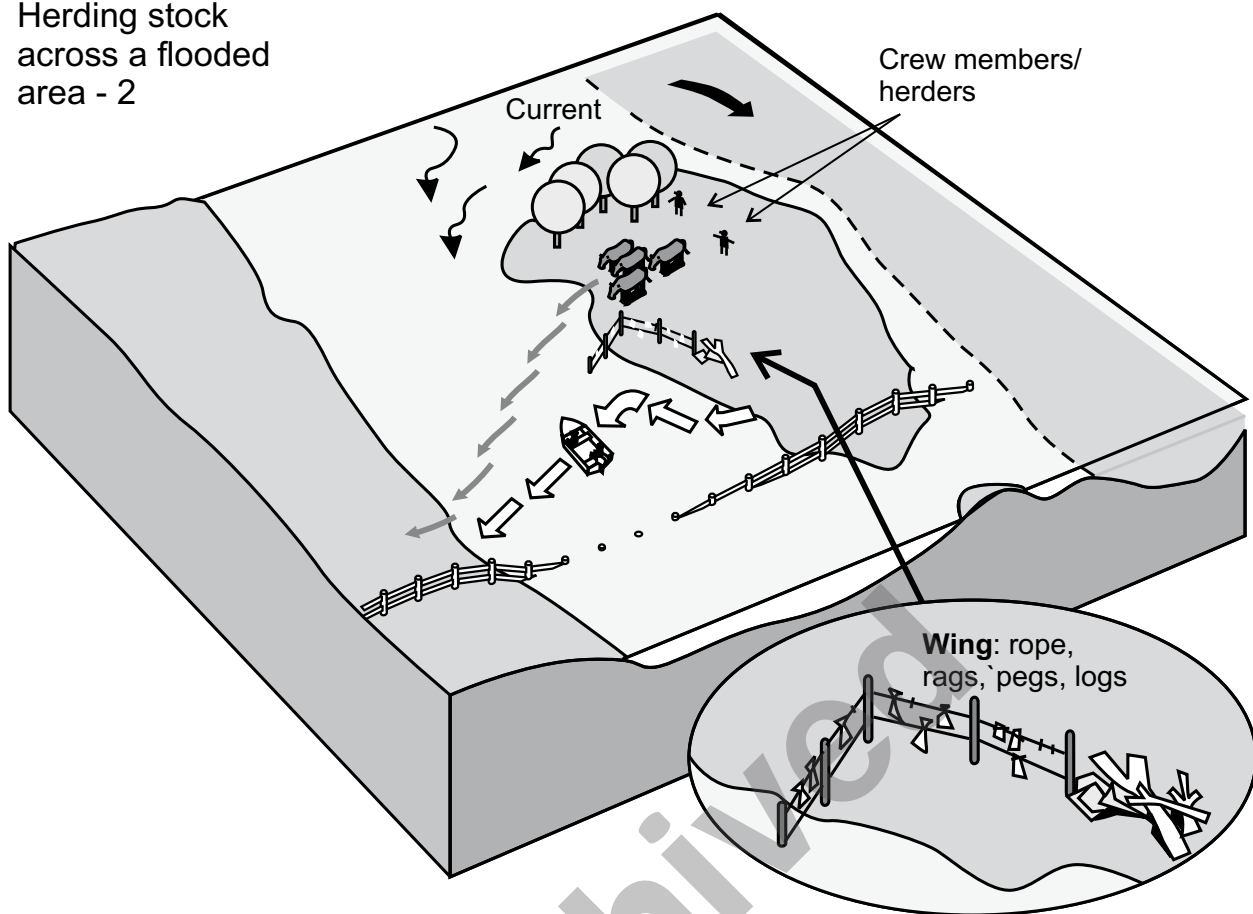

Figure 7:21b
Swimming stock

If a crew finds a cow swimming, it may be able to be led to safety simply by getting alongside it and holding it by the nostrils. Cows have sensitive nostrils and will follow rather than pull against this action. It may be possible to move two animals at the same time this way.

The FRB can also be used like a big sheep dog to herd animals in the direction of safety.

WARNING

If an animal goes mad, let it go. Do not allow it to sink the FRB. Cows can weigh up to a tonne each, heavier than most boats. Stop and take 5. Ask the advice of the property owner or manager.

7.15.4 Calves and foals

If the stock herd has young calves or foals that may not be capable of swimming the distance, they should be caught, their legs secured, and transported across to the dry ground before the rest of the herd.

- Load the young animals at the point where the crossing will begin, allowing the mothers to approach as close as possible.
- Once they are loaded and the boat has started to cross, the rest of the herd will try and follow.
- Unload the young stock close to where the rest of the herd will land.

Carrying calves
across a flooded
area

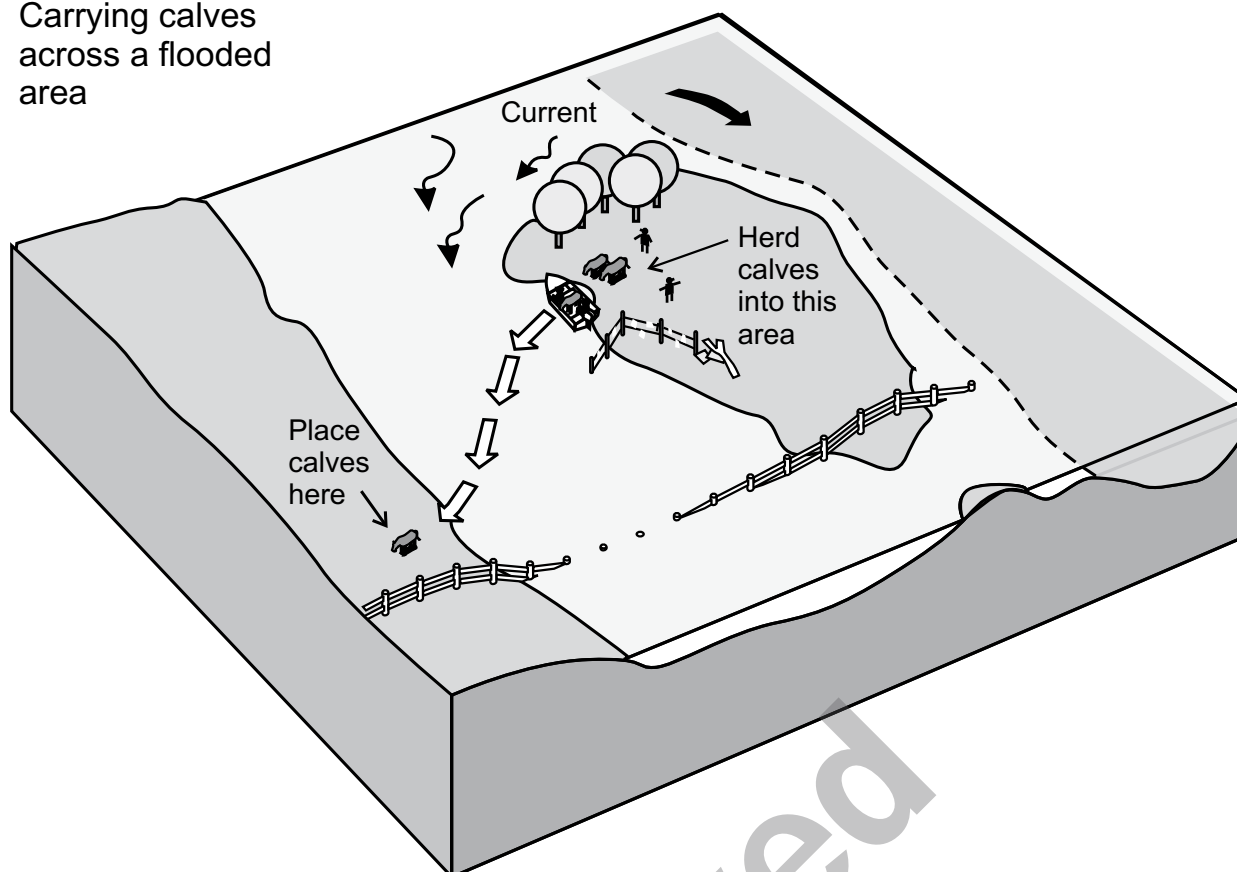

Figure 7:21c
Carrying stock

7.15.5 Other livestock

Large numbers of sheep and goats can also be moved using the above method, but sheep are poor swimmers, especially with a full fleece. Another method is to transport the animals in boats, but this can be dangerous as these animals are difficult to keep still and anything moving in the boat can upset trim and stability and can capsize the boat. **Stop and Take 5.** Animals must be kept still.

Consider using a stock crate (eg from the back of a ute) in a big punt. It needs to be packed tightly with animals so there is limited movement. The crate should also be tied down so the load does not shift.

If crates are not available, use the following method:

- yard the animals as close as possible to deeper water, where launching the boat will be easier when loaded
- catch and secure the animals, usually by tying three legs together (front right and rear two legs) using 300 mm cable ties, hay band or rope—tying the front left leg restricts the animal's heart
- place the animals in the boat in rows and sit them upright on their rear like when shearing—try packing them low, in a central space between seats
- continue loading by placing the next row sitting between the legs of the previous animal
- do not overload the boat
- when loaded, an oar may be used to keep the animals in place during transportation
- be careful when unloading, as the animals may jump into the water rather than on land.

Note: A sheep with a full fleece can hold 10–20 kg of water and will be heavy to load and carry. The water will leak out of the fleece onto the floor and can then be a dangerous shifting weight. Watch for this and bail as needed.

7.16 Operating at night and in poor visibility

7.16.1 Navigation at night

The most important rules to remember when driving a FRB at night are:

- **stop and take 5**
- crew members are at greater risk, so slow down
- keep a good lookout.

FRB crew members should be aware that:

- not all navigation hazards have lights indicating their position, especially moored vessels, shallow areas, oyster leases and many navigation marks
- background lighting on the shore can cause confusion
- debris and hazards (eg waves, shallow water, banks and poles) may be hard to see
- FRBs must have navigation lights.

When operating a FRB at night, crew members should:

- scan around to avoid tunnel vision
- ensure the boat has a powerful spotlight
- apply the rules of safe speed—slow down so no one is hurt if something goes wrong.

7.16.2 Night vision

Eyes adjust to the dark so that after a few minutes crew members should be able to see quite well with very little light. To protect their night vision, crew members should:

- direct search light beams away from the boat
- minimise the use of lights
- use soft (preferably red) light (eg a very small cylume stick or LED light) for reading maps
- look around, rather than right at, objects, to see them best. The most light-sensitive parts of your vision are slightly out of the centre.

7.16.3 Observation skills

To see things, look for:

- shape (eg a cow, a weir, a tree)
- shadow—the shape of a shadow on the ground may best identify the object casting it
- shine (eg house roof, windows, water surface)
- spacing (eg fence posts or road posts ahead)
- silhouette (eg bank, tree, horizon)
- movement (eg other boats, water, debris).

7.16.4 Operations in poor visibility

Fog, heavy rain, smoke, haze or snow can reduce visibility. Crew members need to see and be seen and hear and be heard in reduced visibility to help avoid collisions. To maintain safety, crew members should:

- avoid collisions
- navigate and know where they are
- stop if they become disorientated
- travel at a safe speed so the FRB can come to a complete stop in half the range of visibility
- keep a good lookout at all times
- stop, if necessary, to listen for other vessels—when a sound is heard, work out what it is and where it is coming from
- **stop and take 5** if disorientated
- proceed only when it is safe to do so.

7.17 Vessels in distress

It may be necessary for FRBs to assist with locating and possibly recovering (by towing) other boats, whether they be powered vessels or otherwise. It may also be necessary to tow an object away from a shipping lane or to shore for examination. As with a search for people, the following information would normally be given during the issuing of orders:

- type and size of vessel
- last point at which the vessel was seen
- known course and expected location
- persons on board, if known
- other operational information according to SMEAC.

In large flood operations, however, a crew may come across another boat in distress, or in a location dangerous for itself and other shipping. Simply tow it to safety, if possible. If the vessel is deemed too large to tow, or is grounded, its location and condition should be communicated back to the operations centre to receive further instructions. If the crew members of the disabled vessel are in danger, it may be necessary to evacuate them immediately.

Each situation will present unique problems to FRB crews and team leaders.

7.17.1 Safety

There are a number of safety issues with disabled vessels. FRB crew members should:

- stay well clear of the vessel, preferably downwind, until the situation is clear
- keep a lookout for floating lines and debris, including fuel in the water
- if the vessel is capsized, tap the hull to check for survivors—**never** dive under the hull
- if there are survivors, find out if anyone is missing, and obtain a description and whether they were wearing a PFD or not
- if the vessel cannot be recovered by towing, secure it as much as possible, mark its location and communicate details to the operations centre.

First priority is the safety and recovery of the FRB crew and any survivors, **not** the vessel's recovery:

- if the survivors are in shock, suffering from exposure or injured in some other way, get them to medical aid before trying to recover the vessel
- likewise, if someone is missing, search for the person first and recover the vessel later.

Note: if injuries or fatalities are involved, remember to record as much information from the scene as possible for the police and other investigators.

7.18 Towing boats and debris

Sometimes a FRB crew may be required to tow a broken-down boat or to tow debris from waterways.

7.18.1 Stern towing

Stern towing involves attaching a line to the stern of the towing boat and to the front of the towed object. Crew members should use the following procedure when stern towing:

- use the longest line practicable, as it acts as a shock absorber between the boats
- to centre the tow, form a bridle from your transom using the transom strong points
- attach the tow line to the winching eye on the stem or the bow bollard of the towed vessel
- always take up the strain slowly before accelerating to the tow speed to avoid damaging either boat and snapping the tow line
- the length of the tow should be set at two wave lengths behind the towing vessel, allowing the boats to ride waves together and reduce snatching (jerking)
- snatching can also be reduced by tying a weight, such as an anchor, in the middle of the tow line
- the towed vessel should have the motor trimmed down and should be steered
- if the towed vessel veers around, trim the motor out and/or add weight to the stern of the towed boat
- the tow speed will depend on water conditions but a low speed of about 8–14 km per hour will reduce the strain on both boats
- in currents the tow speed must be greater than the water speed, when travelling with the current, to avoid the towed vessel over-running the tow vessel. It is best to plan upstream tows in currents.

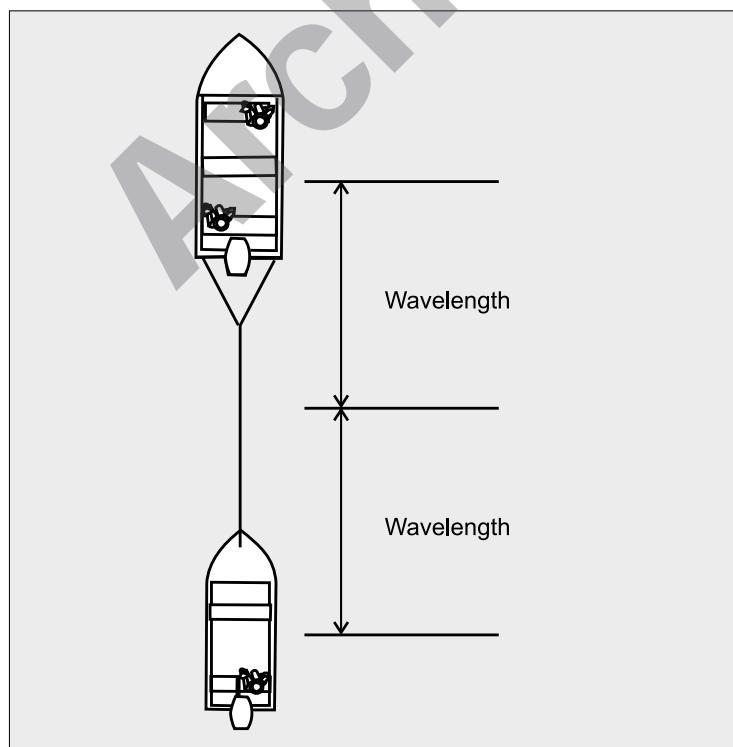

Figure 7:22
Stern tow

7.18.2 Barge towing

When barge towing, the disabled boat is tied alongside the towing boat. The success of a barge tow depends on the correct setup:

- place fenders between the boats
- the motor of the towing boat should be positioned well behind the stern of the towed boat
- the towed boat should be angled slightly into the towing vessel.

Stop and take 5: before beginning a tow, FRB crew members should consider whether they and their boat are capable of the tow.

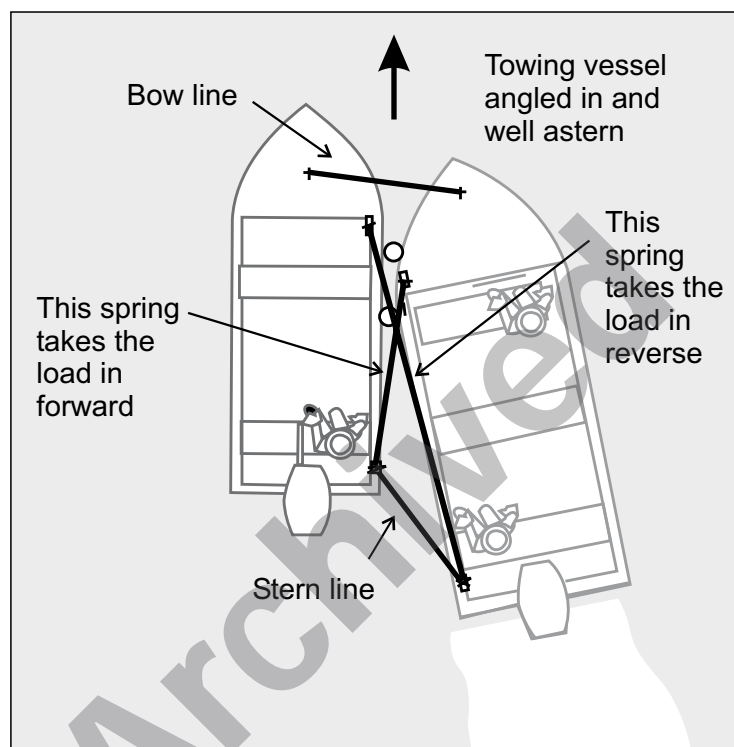

Figure 7:23
Barge tow

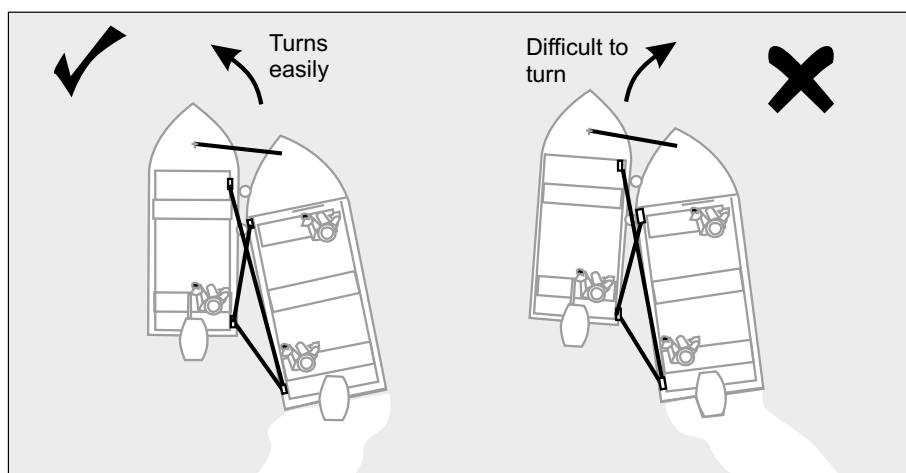

Figure 7:24a
Manoeuvring during barge tow

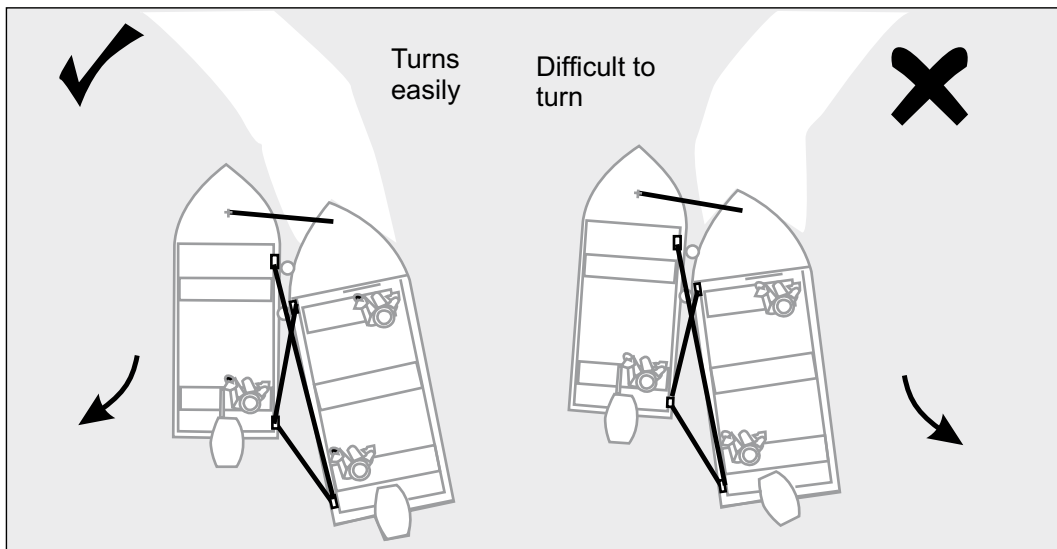

Figure 7:24b

Manoeuvring during barge tow

7.18.3 Bridles

A bridle may be preferred if towing over a long distance. The bridle helps keep the towed FRB as close as possible to the centre line of the towing FRB. Two forms of bridle can be used—with or without pulley blocks.

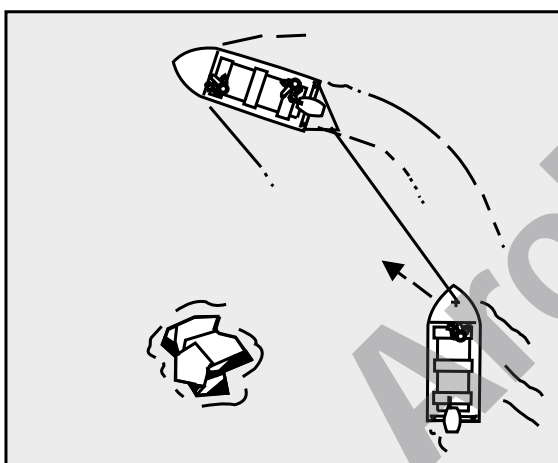

Figure 7:25a

Towing with a bridle

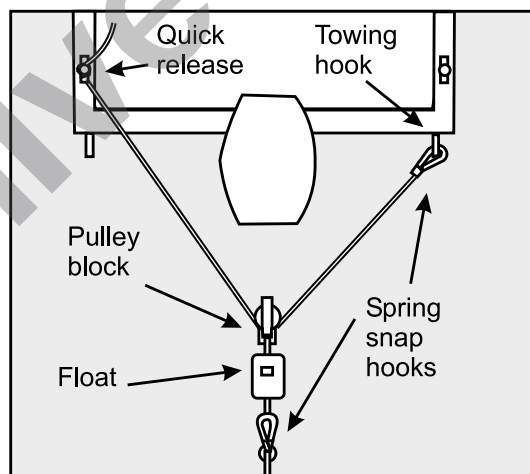

Figure 7:25b

Bridle with pulley block

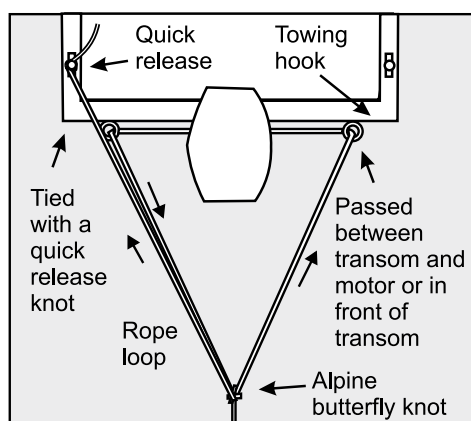

Figure 7:25c

Hand-tied bridle

7.18.4 Turning

When turning, allowance must be made for the tow as it may tend to cut across the arc of the turn and could foul any object around which a turn is being made (see Figure 7:28a). It is advisable to shorten the tow when turning or manoeuvring in confined waters.

7.18.5 Crew positions

At least one crew member must be aft to watch the towline. The crew member must warn the coxswain of any impending threat, such as fouling the tow line in the propeller, and must be prepared, if ordered, to slip or cut the towline where there is any danger to either boat.

7.18.6 Casting off

When casting off a tow, the boat being towed should let go. This ensures the tow line is on board the towing FRB in case it is needed again.

Once cast off, the tow line should be hauled on board and kept clear of the propeller. After casting off or if slowing down, the crew members of both boats should be prepared to fend off because the boat being towed may tend to surge forward.

Use a quick release in case a problem occurs. Crew members should:

- turn the tow rope around a cleat (with a figure-of-eight), but do not tie it off—the crew member holding the tow line should be able to just let go of the rope
- take some round turns on a rail so the crew member holding the tow rope can let go
- set up a self-releasing improvised bridle
- have a knife handy in case the tow line does not release.

The crew of the towed vessel should:

- be fully briefed
- steer the towed boat
- be prepared to let the tow go if a problem occurs.

7.19 Outboard fault finding

Should your outboard stop running or fail to start, refer to the flowcharts in Figures 7:26a and 7:26b.

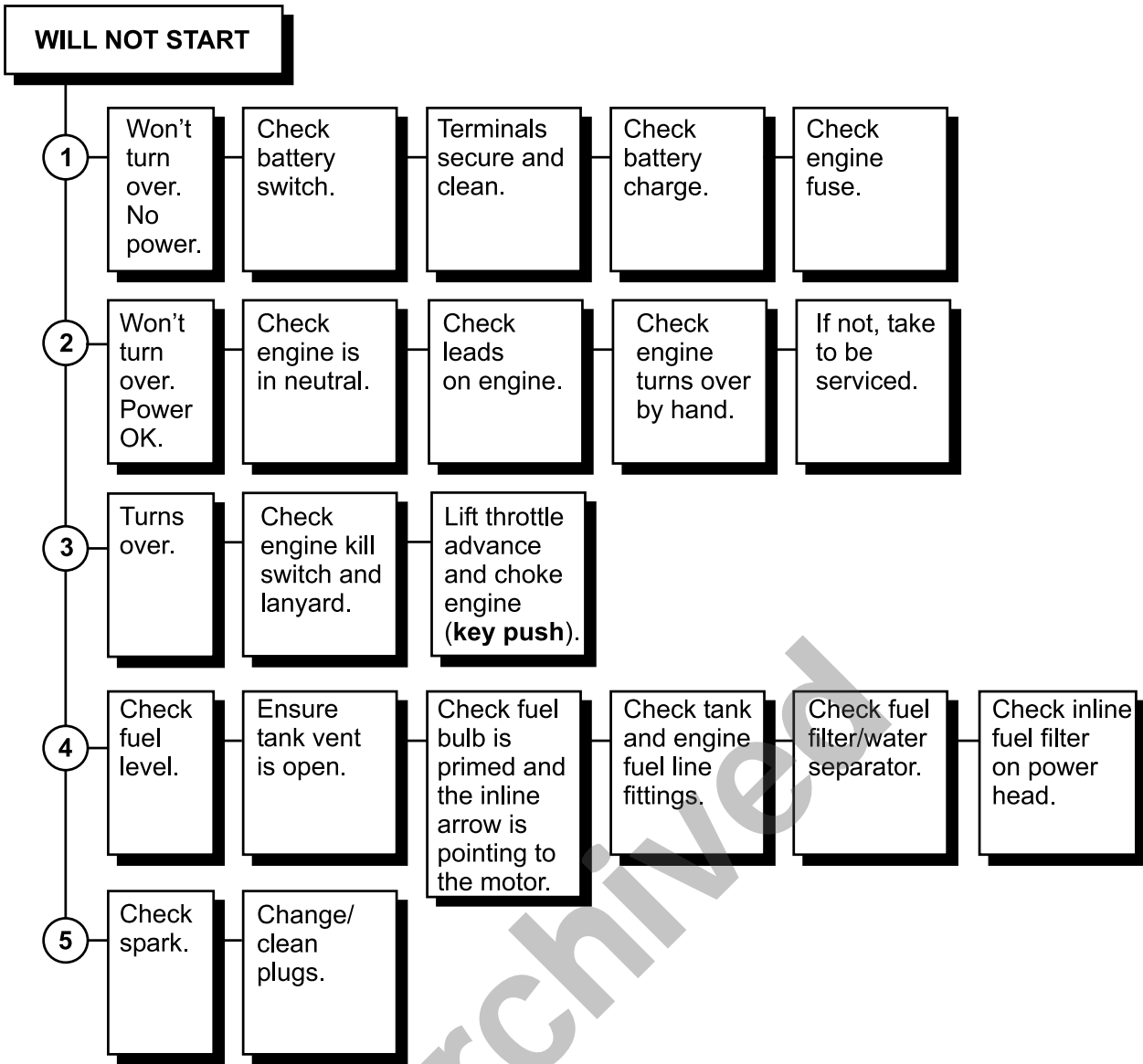

Figure 7:26a
Fault finding

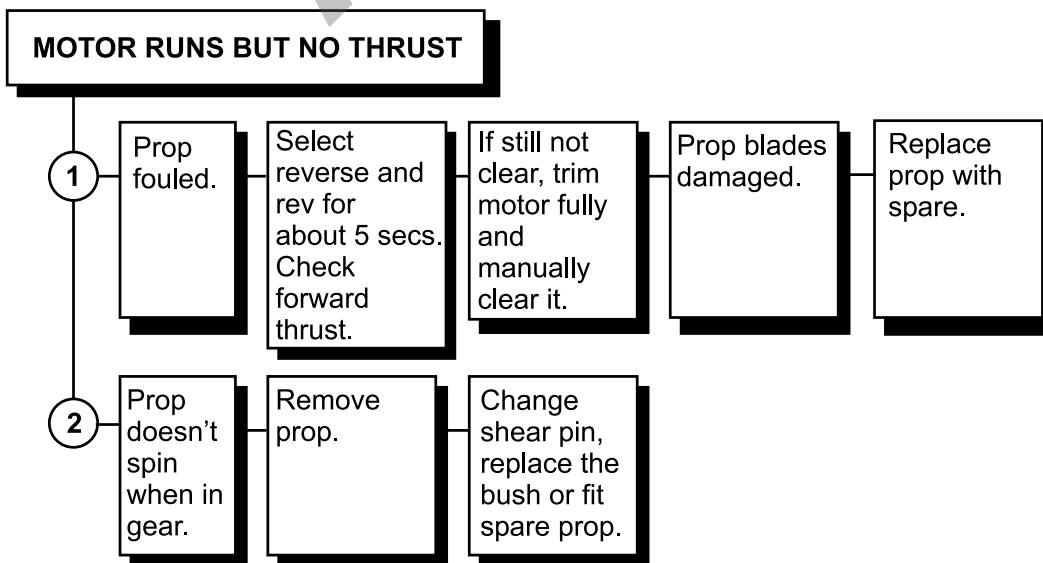

Figure 7:26b
Fault finding

7.19.1 Drowned motor

An outboard motor may 'drown'. This may result from a capsized, the motor detaching from the transom or the FRB being swamped by a wave.

To revive a drowned motor:

- remove the motor cowling and wash off any sand or dirt with fresh water
- remove the spark plugs and drain any water from the cylinders
- remove the carburettor drain screw and fuel hoses and drain any contaminated fuel from them
- reconnect the fuel lines with a fresh tank of fuel and pump clean fuel through the line and carburettor—when the fuel coming from the carburettors is clean, replace the drain screws
- drain contaminated engine oil and replace (four-stroke engines only)
- drain and replace oil in oil-injected two-stroke engines where they have a oil reservoir
- crank the motor over until water no longer drains from the spark plug holes
- pour a small amount of mixed fuel into each spark plug hole
- refit the spark plugs
- displace moisture from all electrical fittings and connections using a dewatering spray
- restart the motor and run it under varying loads at three-quarter throttle for a minimum of 30 minutes
- if spare oil is available, add extra so the fuel:oil ratio is 25:1 for the first tank.

As soon as possible after returning to base, ensure the motor is inspected by a qualified outboard mechanic.

7.19.2 Lost motor

Stop and take 5 and assess the options if a motor goes overboard. Options may be to:

- row or paddle to shore
- drop anchor and stop the boat so that it is as near as possible to where the motor disappeared
- locate the motor by the presence of bubbles or fuel/oil stains, which may indicate where the motor is—throw a spare life jacket with line and weight attached to mark the spot
- call for assistance from any other boats in the area
- locate the motor with grapples, or by any other means available
- recover the motor and conduct the drowned motor procedure.

End of chapter. This page left intentionally blank.

Archived

CHAPTER 8

Inland Water Search and Body Recovery

FRBs may be used to help police with searches of inland waterways for a missing person and lost or stolen property. It is important to remember that the police have control of these situations, especially in missing-person and evidence searches, because they are responsible for the chain of evidence and reporting to the State/Territory coroner. FRBs fill a support role and supply the police with resources and personnel. It is therefore important for FRB crews to:

- be fully briefed by the police search and rescue mission controller or police officer in charge
- maintain liaison with police at all times
- conduct all operations and duties under the direction of the police.

8.1 Search patterns

There are many different types of search patterns. The most frequently used search patterns are:

- parallel
- track line
- expanding square
- sector.

Track spacings will be determined by search control, which will consider factors such as visibility and size of target.

8.1.1 Parallel search

A parallel search is the most common search pattern.

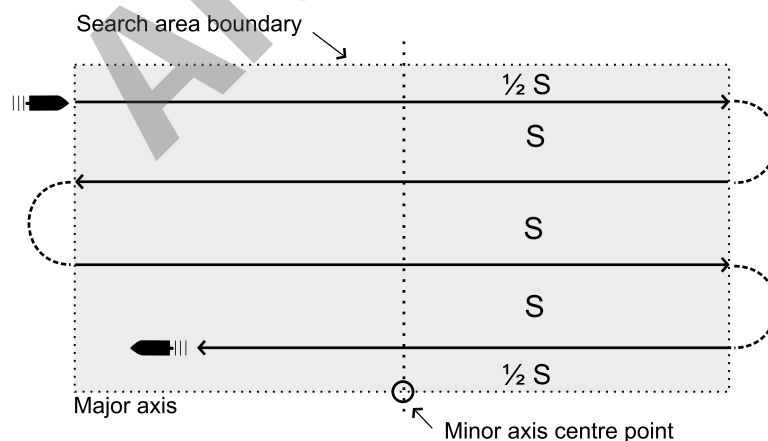

Figure 8:1
Parallel search

8.1.2 Track line search

Track line searches are used for an initial response search when a boat is missing along a route.

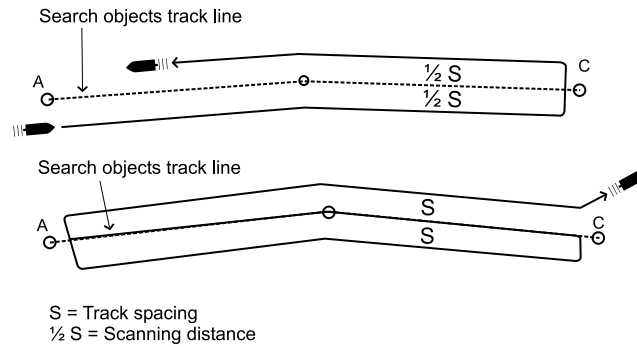

Figure 8:2
Track line search

8.1.3 Expanding square search

Expanding square searches are useful when a point of interest is known (such as the last position a person was seen before going missing) and the immediate area needs to be searched quickly.

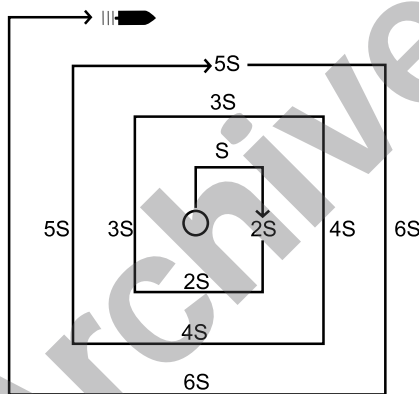

Figure 8:3
Expanding square search

8.1.4 Sector search

A sector search can be used in a similar way to an expanding square search. It is also useful in smaller search areas where the boundaries are not symmetrical, such as small lakes.

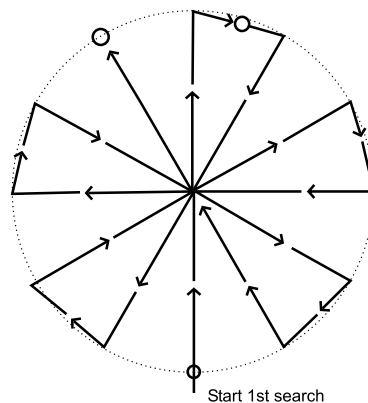

Figure 8:4
sector search

8.2 Underwater search methods

Methods used for searching small areas underwater are:

- probing
- dragging.

A FRB crew may not have the proper tools for a bottom search but may be able to improvise suitable tools from common items found around the local unit.

IMPORTANT

Do not use any probing or dragging techniques without authorisation from the police officer in charge.

8.2.1 Probing

The probing method is not very efficient because it is difficult to ensure complete coverage of the search area. However, it is useful in shallow water where there is debris or snags (logs, rubbish or trees). Probing tools can be improvised from boat hooks, garden rakes, hoes or similar tools attached to long poles or saplings.

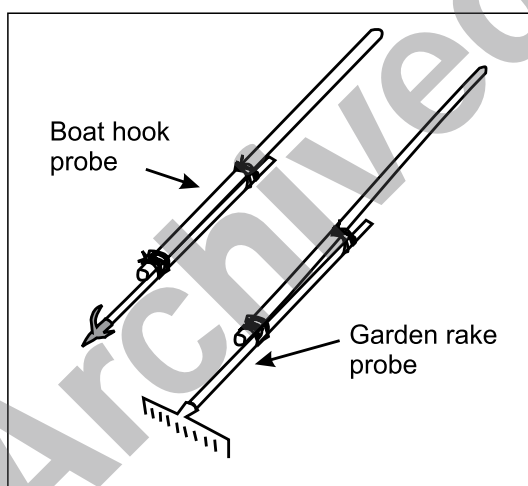

Figure 8:5
Probing

8.2.2 Dragging

Where the bottom is flat and clear of debris or snags, dragging is an efficient search method. When dragging, three types of improvised dragging tools can be used.

Technique 1:

- Use a panel of welded mesh or similar material 2 m x 1 m.
- Create a leading edge by bending one of the longer edges over. This will assist the device in riding clear of mud and snags. The fold must not be greater than 50 mm or it may resist picking up a body.
- Cut transverse frames on the trailing edge from the panel.
- Bend alternate frames up and down to form hooks.
- Attach a towing bridle.

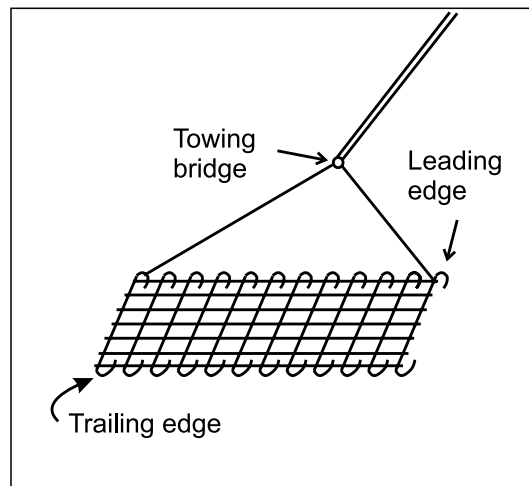

Figure 8:6
Dragging technique 1

Technique 2:

- a. Bend a bar into an arrowhead.
- b. Weld an eyelet at the apex (at the bend) of the bar.
- c. Attach a light chain or bar across the wide opening to create an 'A' shape.
- d. Attach triple hooks at moderate intervals along the chain or bar. If required, file down the barbs to avoid unwanted snagging.

When completed, the device may be used either weighted or unweighted. If weighted, the drag travels along the bottom and is intended to pick up a body lying on the bottom. The body will normally be lifted onto the device and held by the uppermost hooks. If unweighted, the device may pass over a body and snag with the lower hooks.

Remember: the drag is moved in a series of sweeps until the area of probability has been covered. A reasonably detailed search of an area may be achieved with this method.

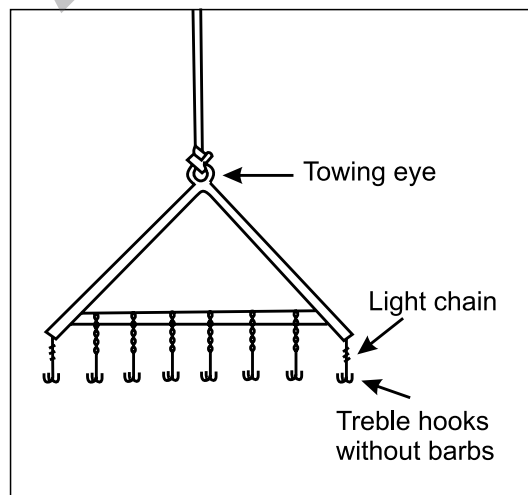

Figure 8:7
Dragging technique 2

Technique 3:

- a. Improvised grappling hooks can be made from reef anchors.
- b. Alternatively, a number of small reef anchors made of lighter materials can be attached to a bar to form a drag bar.

A grapple search (grappling) can be used in either shallow or deep water that is free of snags. The grapple may be used by dropping it into gaps between snags or it may be used as a form of drag.

8.2.3 Dragging techniques

Shore-to-shore dragging is a method that can be used where using a FRB is not possible. At least two people are necessary.

- a. Secure the drag to the centre of the rope, which should be twice the width of the area to be dragged.
- b. Crew member A drags slowly from the opposite side of the area toward him/herself.
- c. Crew member A signals crew member B, who moves half the width of the drag and drags in the opposite direction.
- d. After each sweep A and B move half a width alternately until the area is covered.
- e. This procedure is then reversed so that the bottom is covered from the opposite direction.

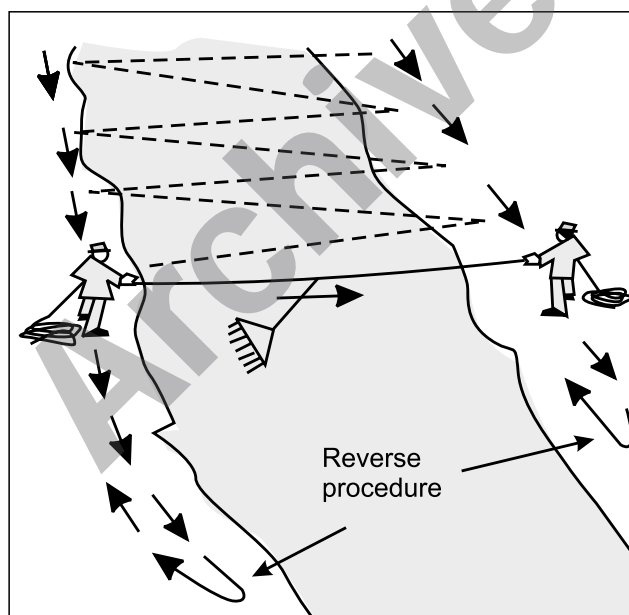

Figure 8:8
Shore-to-shore dragging

FRB-to-shore dragging can be used where it is necessary to use a FRB on one boundary of the search area.

- a. The FRB is securely anchored fore and aft.
- b. A crew member on shore does all of the moving by sidestepping half of the length of the dragging bar on each sweep.

If dragging from position A is not successful, the boat is moved to position B (one FRB length) and the procedure is repeated until the area has been searched.

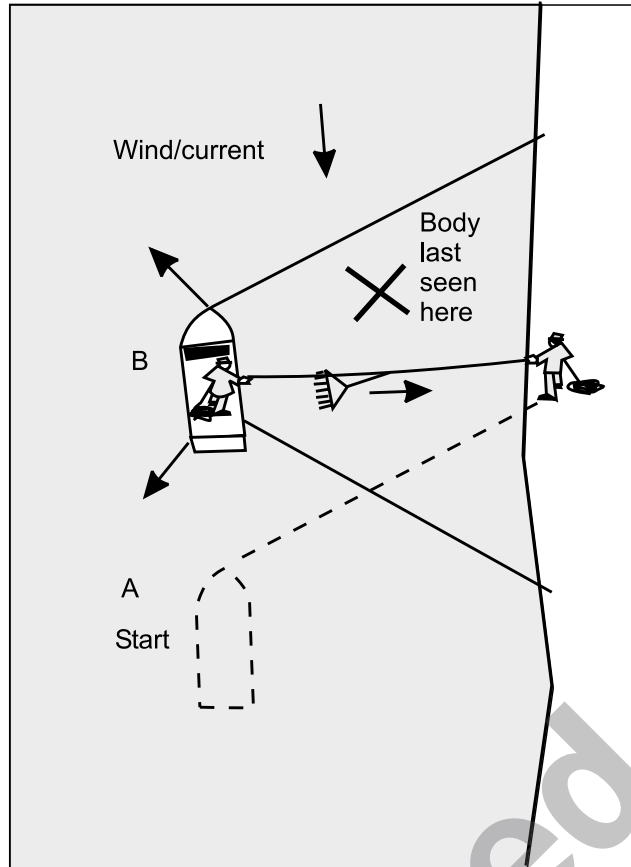

Figure 8:9
Boat-to-shore dragging

FRB-to-vessel dragging is a method that can be used where the whole operation must be conducted from FRBs because of the distance from shore.

- Four buoys are placed to mark the area to be searched.
- FRBs are anchored fore and aft with bows in the same direction.
- An area the length of the FRB is grappled, then FRB A moves forward until its stern is level with the bow of FRB B.
- FRB B is then brought level with A.
- The procedure continues until the area has been swept.

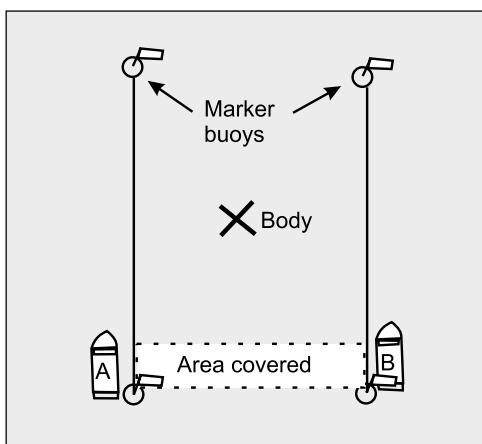

Figure 8:10a
Boat-to-boat dragging

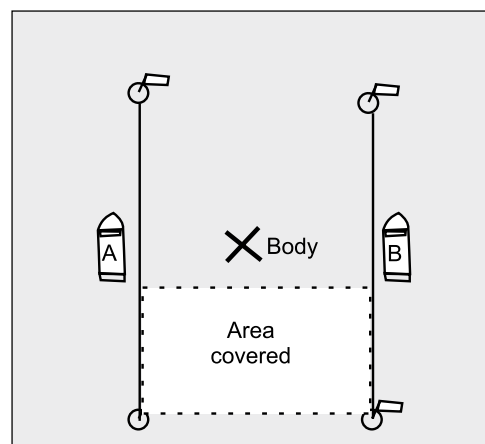

Figure 8:10b
Boat-to-boat dragging

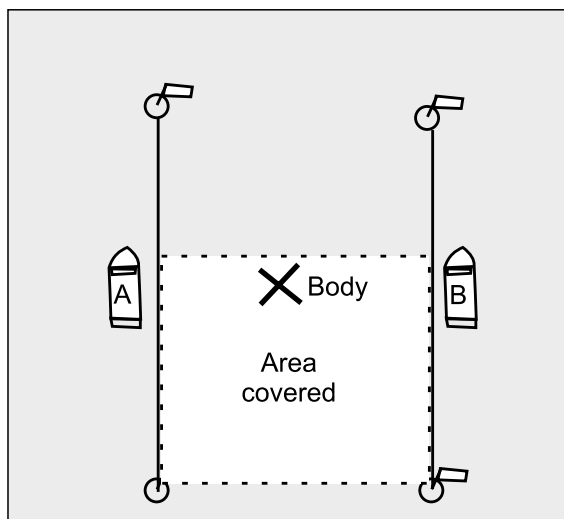

Figure 8:10c
Boat-to-boat dragging

WARNING

Attach a buoy to the grapple so that it can be easily located.

8.2.4 Nets and body fences

In currents a large fishing net or body fence placed well downstream and crossing the full width may assist in catching a body being washed downstream.

It is important to find a slow-moving section of stream, as fast or turbulent water reduces the effectiveness of a net and can force a body to float under or push the fence/net to the surface.

Fences can be made of wire mesh or fencing material.

For both nets and body fences, it is important to:

- fasten the net or fence to the bank securely
- check the net/body fence regularly
- use strong anchors
- attach weighted or anchored floats and drums to the net/body fence so that its location is known.

8.3 Locating a body

If a body is located:

- notify the police and maintain security on the body
- protect and preserve the scene
- shield the body from onlookers by using the boat or a tarp as a screen
- wait for directions from the police.

8.4 Recovering a body

Always have a police officer present when recovering bodies, as recovery may be part of criminal or coronial investigations.

To assist in handling and recovering a body, crew members can use the following equipment:

- a basket stretcher
- wire netting or shade cloth
- blankets, tarpaulins or body bags
- disposable gloves
- disposable overalls
- full-cover eye protection.

Once a body is recovered, crew members should:

- avoid carrying bodies in the FRB to avoid contamination
- place the body into a body bag (to avoid loss of forensic evidence)
- tow the body slowly into shore using a rope tied to one corner of the body bag with a clove hitch, or
- place the body bag into a basket stretcher and lash the stretcher to the boat (forward and aft) and tow it slowly to shore. If this cannot be done, take precautions to limit the contamination of the boat using a tarpaulin, plastic sheets, shade cloth and/or body bags.

On completion of body recovery operations ensure all crew members and equipment are disinfected and cleaned as necessary.

WARNING

Do not get into the water to assist with the recovery of bodies—suitable PPE is not usually provided to protect crews from the hazards associated with this type of recovery. This type of recovery is a police responsibility (eg police divers).

8.4.1 Body flotation

In still water a body will generally remain in the vicinity where the drowning occurred.

Even in a moderate current, a body is likely to remain in the vicinity of the drowning.

Overweight or obese victims and bodies of small children may not sink after drowning but may remain floating on the surface. A fully clothed body may be further from the spot because some air is trapped in the clothing, but this should not extend the distance too greatly.

The location of the body is a greater problem when victims drown in rapids or fast-flowing waters. Often the body may be lodged in the first deep hole downstream or may be held against an underwater obstruction by water pressure.

8.4.2 Body submergence time

Bodies rise to the surface when enough gas is formed in the intestinal tract and other body cavities to make the body buoyant. The temperature of the water, age of the person and the contents of the stomach at the time the victim drowned will have a bearing on the time a body stays submerged. In summer the average time for a body to surface is about 24 hours. In winter or in very cold water, the time may be greater (sometimes up to two weeks).

As bodies become buoyant they move with the prevailing winds, currents and tides until continued decomposition allows the gases to escape and the body sinks again.

8.5 Working with police divers

Underwater diving search and recovery is a specialist and potentially dangerous task that is generally outside the role of FRB operations. However, there may be occasions for FRB crews to act in support of divers involved in bottom searches for bodies or objects.

All diving search and recovery operations are carried out by police divers only. Generally, divers are called in when there is little likelihood of recovering victims alive; the response time is often measured in hours or even days if they are already busy elsewhere. Dive operations require patience, both in the initial response time and in the methodical approach to the task.

The FRB crew leader or person in command should liaise with both the police officer in charge and the diving supervisor to establish clearly the tasks to be carried out by both the FRB and the crew members. Information that must be sought includes:

- What is the job of the FRB? Is it acting as a diving tender, safety boat, surface search, ferry, or other vessel?
- What equipment and personnel will be travelling in the FRB?
- What search patterns and methods of operation will be used?
- What safety precautions and signals will be used?
- What speeds and distances off should the FRB maintain?
- What action is to be taken in the event of a find or a problem?
- What hazards are likely to be encountered?

Police dive teams are usually self-sufficient and require little assistance other than getting to and from the dive site. Crew members may be able to assist the dive team by carrying equipment, loading the equipment into the FRB and helping the diver aboard.

All FRBs must comply with State/Territory legislation regarding navigation in the vicinity of a dive flag.

8.6 Working with helicopters

All aircraft are potentially dangerous, but helicopters create particularly high levels of risk. Some of the specific hazards that FRB crew members should be aware of are listed below.

8.6.1 Rotor blades

FRB crew members should be aware that:

- at idle, rotor blades travel at 300 km/h
- on level ground, rotor blades may tilt down to head height (1.5 m)
- the tail rotor may be unprotected
- rotor blades are difficult to see due to rotational speed.

8.6.2 Radio antenna

Helicopters have a number of radio antennas, some of which are capable of causing radiation injuries if touched while they are transmitting (**never** touch antenna).

8.6.3 Static electricity

A helicopter in flight can build up a static electric charge as high as 250,000 volts. This static electricity must be discharged before a person on the ground can safely touch any part of the helicopter. The static electricity discharges within moments of the helicopter touching the ground.

FRB crew members should be aware that:

- touching an aircraft before it is earthed may cause severe and even fatal shocks
- ground contact of two to three seconds is required to discharge the static electricity.

8.6.4 Approaching and leaving a helicopter

Always get the pilot's/crew's approval before approaching a helicopter. The standard signal is a 'thumbs up' from the pilot/crew. When approaching a helicopter secure all loose items (eg hats) and keep low.

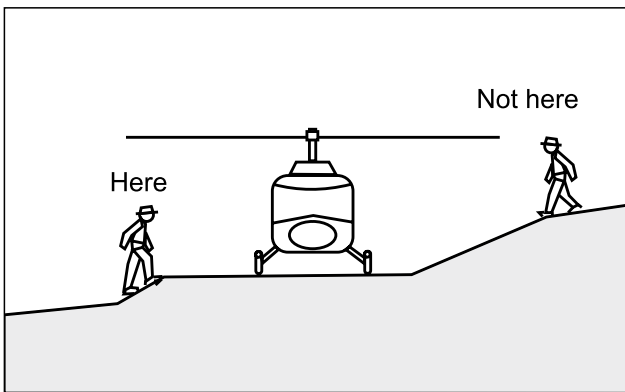

Figure 8:11a

Approaching a helicopter

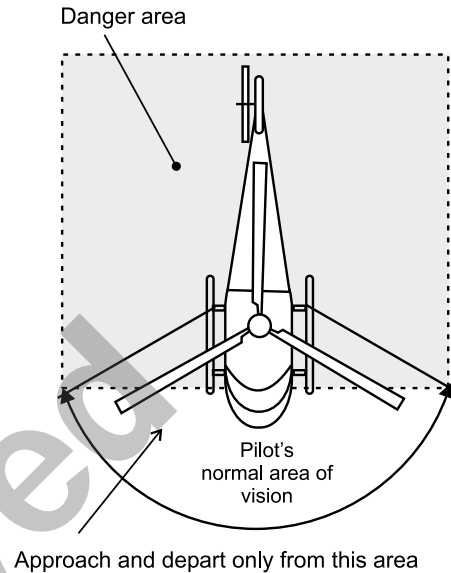

Figure 8:11b

Approaching a helicopter

Observe the following rules at all times when approaching and leaving a helicopter:

- do not smoke in or around aircraft
- never approach or depart from a helicopter without the pilot's/crew's authorisation
- do not move onto the landing area until the aircraft has completely shut down and directions have been given by the pilot/crew
- always approach from the front of the helicopter and remain in the pilot's field of vision (between the 10 o'clock and 2 o'clock position)
- do not enter under the rotor disc until the pilot returns a 'thumbs up' signal (even if the engine is not running)
- stay away from spinning main and tail rotor blades—they are not readily visible. A slow main rotor can tilt downwards, especially in windy weather
- approach helicopters in the crouched position and watch the rotor blades
- approach and leave a helicopter from the downhill side
- always wear eye protection when approaching/departing
- never load any person or equipment without the pilot's/crew's knowledge
- always use two people to carry long objects and carry them parallel to the ground
- do not touch the helicopter unnecessarily
- watch for, and warn, people breaching these safety rules
- hold objects firmly—never reach for any object that has blown away
- remove all hats and caps unless held by a chinstrap.

When approaching a helicopter in a vehicle:

- do not approach while rotors are turning
- approach only when the engine is not operating and only with permission of the pilot or crew.

8.6.5 Dust and debris

If blinded by dust or debris from the rotor down force, stop immediately. Cover your eyes with both hands, crouch down on the ground and wait for help to come. Never try to feel your way to or from the aircraft.

8.6.6 Landing area procedures

Landing area procedures should be instituted approximately 10 minutes before an aircraft lands:

- stay well clear of the area
- secure all objects within two rotor diameters
- clean up the area (plastic, paper bags, cigarette packets, and so on) thoroughly
- wet down the area if dusty.

8.6.7 Night landings

Do not use cameras with flashlights, or strobe lights, as these may interfere with the pilot's vision.

8.6.8 Winching

The downdraught from the rotors of a hovering helicopter plays havoc with unsecured FRBs and hinders a person or cargo being lowered into or retrieved from a FRB. If possible, it is safest for the helicopter to land and transfer people while it is on the ground.

If the helicopter cannot land and passenger/casualties need to be winched from a FRB, the FRB crew should consider:

- moving to the nearest shore, or
- moving to a safe body of water (eg out of currents), and
- securing the FRB fore and aft by anchors, or
- securing the FRB to a structure or other solid anchor point.

The winching operation is directed by the helicopter crew.

8.7 Tides and currents

Tides and currents are natural occurrences but, particularly in a flood situation, they can have an important effect on FRB operations. In some areas in northern Australia, tidal currents can be extreme and at times dangerous, and currents may push a boat off course without the crew realising what is happening. A knowledge of tides is also required when launching from boat ramps, anchoring or operating in estuaries and rivers. The following is basic information on these conditions.

8.7.1 Tides versus currents

The easiest way to remember the difference between tides and currents is that:

- tide is vertical change
- current is horizontal change.

A **tide** is the rise and fall of the ocean level as a result of changes in the gravitational pull of the earth, moon and sun.

A **current** is the horizontal movement of water from any cause at all.

A **tidal current** is the flow of water between any two points that are affected by tidal changes in height (ie from a point of high tide to a point of low tide).

8.7.2 Tidal action

Tidal action is the primary cause of currents. Tides are an important factor in safe navigation and operation of FRBs. The effects of tide are often observed at beaches, in rivers and bays as the water levels rise and fall, leaving a beach uncovered, sometimes for many kilometres out to sea, creating dangerous conditions for fishers and waders.

8.7.3 Terminology of tides

The terms used to describe tides and tidal conditions are important when studying tidal charts and information. These terms are :

- **high tide (water)**—the highest point reached by a rising tide
- **low tide (water)**—the lowest point reached by a falling tide
- **range of tide**—the difference between high and low tide
- **height of tide**—the vertical measurement of the tide above the surface of the water as charted at any time (eg a 1 m tide at 0300 hours)
- **charted depth/tidal datum**—usually taken as the depth of average low water height; it is marked on marine charts (eg 3 m)
- **depth of water**—the vertical measurement of the water from the surface to the bottom (eg a 1 m tide height at 0300 hours added to 3 m of water depth on the chart equals a depth of water of 4 m)
- **stand of tide**—the period at either the bottom or the top of the tide when there are periods of little or no tidal movement.

8.7.4 Tidal information

The behaviour of tides can be predicted with reasonable accuracy by observing the time, phases of the moon, and the location of a point on the earth in relation to the sun and moon. This information is compiled into tide tables, which are used by newspapers, radio, television and the Internet to provide times and heights to the public, including FRB crews. FRB crews that operate in tide-affected areas should have a copy of the tide tables for their locations.

However, flood conditions and even prolonged periods of bad weather can affect the accuracy of this information. Information relevant to crews includes:

- height and time of high tide today and tomorrow
- height and time of low tide today and tomorrow.

At the same time there will be a slight time difference between points on the coast where tidal information has been collected and this, along with existing conditions, must be taken into account by crews before departing.

8.7.5 Currents

Water may be moved horizontally, creating currents, for a number of reasons.

- a. **Tidal currents** occur in coastal areas and are explained above. Tidal currents first flow one way and then the other, with a stand of tide in between each period. As previously mentioned, some tidal currents can be extremely dangerous, particularly in narrow entry and exit points along the coast.
- a. **River currents** are normally those above the areas affected by tidal currents and are affected by width and depth of the stream, recent rainfall, season of the year and flood conditions. During flood conditions, river currents, along with the debris carried along by these, are among the most significant hazards faced by crews. In some rivers affected by tides, river currents merge into tidal currents; these junction points can be very unpredictable.

- b. **Wind-driven currents** are usually temporary conditions, but may also be caused by sustained wind patterns. Generally, a steady wind of 12 hours or longer will produce a noticeable current that may affect the progress of a FRB. The effect of wind on water will usually be much more noticeable on large water bodies such as lakes and seas.

8.7.6 Terminology of currents

The following terms are used in regard to the characteristics of currents:

- **current drift**—the speed of the current, measured as knots in the sea and kilometres per hour when describing river currents; measured to the nearest one-tenth
- **current set**—the direction of the current in degrees or compass points (eg south-west)
- **current flood**—when the current flows in from the sea and causes higher tides
- **current ebb**—when the current flows out to sea and the water levels fall
- **current slack**—the period during which currents reverse direction and in which there is little or no movement of water (this is different from tidal stand in that there is no set time when this may occur).

8.7.7 Affects of currents

Currents may affect FRB crews in a number of ways, the most obvious being safety issues. One less obvious one is running out of fuel, as the motor will use much more fuel when working against currents.

Currents may also affect the course of the boat. For example, a 12-knot boat speed and a 2-knot current could result in either a 10-knot or a 14-knot speed made good. This is significant both for times estimated to reach a location and for fuel consumption. Even a small current (eg half a knot) can affect a swimmer in the water or rowers.

8.7.8 Difficult areas

FRB crews need to familiarise themselves with local conditions, particularly areas affected by tide and current. The most difficult conditions may arise at the entrances to rivers, gorges, estuaries and bays, where there may be surf, rips and a convergence of tide and current.

Even inland water bodies may have currents so strong that it is difficult or impossible for FRBs to make headway safely.

End of chapter. This page left intentionally blank.

Archived

CHAPTER 9

Operating in Currents

9.1 Floodwater behaviour

It is important to know about a river and the habits of floodwater and moving water before attempting to put a FRB on it. There is enormous power in moving water and it must not be underestimated. The basic principle of operating a FRB in moving water is to avoid or minimise the power of the water or make it work to your advantage.

9.1.1 The force of water

As the speed of water increases, so does the force. Every time the water speed doubles, the force of the water multiplies by four.

CURRENT SPEED km/hr	FORCE ON LEGS kg of force	FORCE ON BODY kg of force	FORCE ON SWAMPED BOAT (SMALL PUNT) kg of force
2	7.6	15.3	76.2
3.7	30.5	60.8	305
5.6	69	137	686
7.5	122	244	1219

Source: Adapted from Slim Ray, *Swiftwater Rescue*, CFS Press, Asheville, NC, 1997.

9.1.2 How fast can water flow?

Experts have measured alpine river speeds, and the fastest water found, even on steep, runoff-swollen alpine rivers, was 17.5 km/h. Sections of the river where observers thought the river moved 'very fast' were actually measured at 12 km/h.

In constructed flood channels, like those in the United States, where there is a smooth bottom and sides with no obstacles, water speed has been measured at over 48 km/h.

As water speed increases, so does its carrying capacity. Rivers in flood can carry very heavy objects like boulders and trucks, and can destroy buildings and bridges. When a river's speed and volume decrease, heavier objects begin to settle, leaving the characteristic debris trail of a flood.

Important characteristics to note are that:

- **moving water doesn't let up**—unlike ocean waves that break and then ebb, floodwater currents push against an object continuously. Once in the current, do not expect any relief from the water's force.
- **moving water is predictable**—while fast-flowing water may look random and confused, it is not. Moving water is actually predictable and acts the same in a small creek as in a large river; it is just a matter of scale.

9.1.3 River variables

The nature of any river depends on three things:

- the amount of water
- how fast it moves
- what is in its bed and along the banks.

If any of these variables change, the river changes. This can happen very quickly.

Rivers are gravity driven. The greater the fall between two points, the faster the water moves.

As a river rises in a flood, it picks up debris from the banks. If the river seems to have more debris than usual, it is a good indication that the water is rising.

Generally speaking, as a river's gradient and volume increase, so do the size and number of rapids.

9.1.4 Rivers in flood

Most rivers have a range of normal levels where the river flows within its banks and is relatively predictable, such as low water during a drought and high water after a storm. Floods, however, are outside the usual range of river conditions and cause a river to overtop its banks and flow through the flood plain or the low areas along the river. In the process, it becomes less predictable and more dangerous.

Under flood conditions:

- the size and power of a river are greatly increased, as is the carrying capacity
- the river's swollen main current strikes the bank and ricochets off, instead of gently rounding, a bend
- almost all river hazards become more dangerous and new dangers are created (eg there may not be enough clearance under a bridge or powerlines for a boat to pass)
- floodwaters are laden with debris, which can clog intakes and foul boat propellers
- trees and other heavy objects join the river's flow, often collecting against bridges to form strainers or natural dams
- as the river flows through built-up areas and farms, the danger of contamination from pesticides, sewage, dead livestock and chemicals greatly increases
- eddies, eddy lines, whirlpools, standing waves and rapids may form in rivers that are normally slow moving and tame.

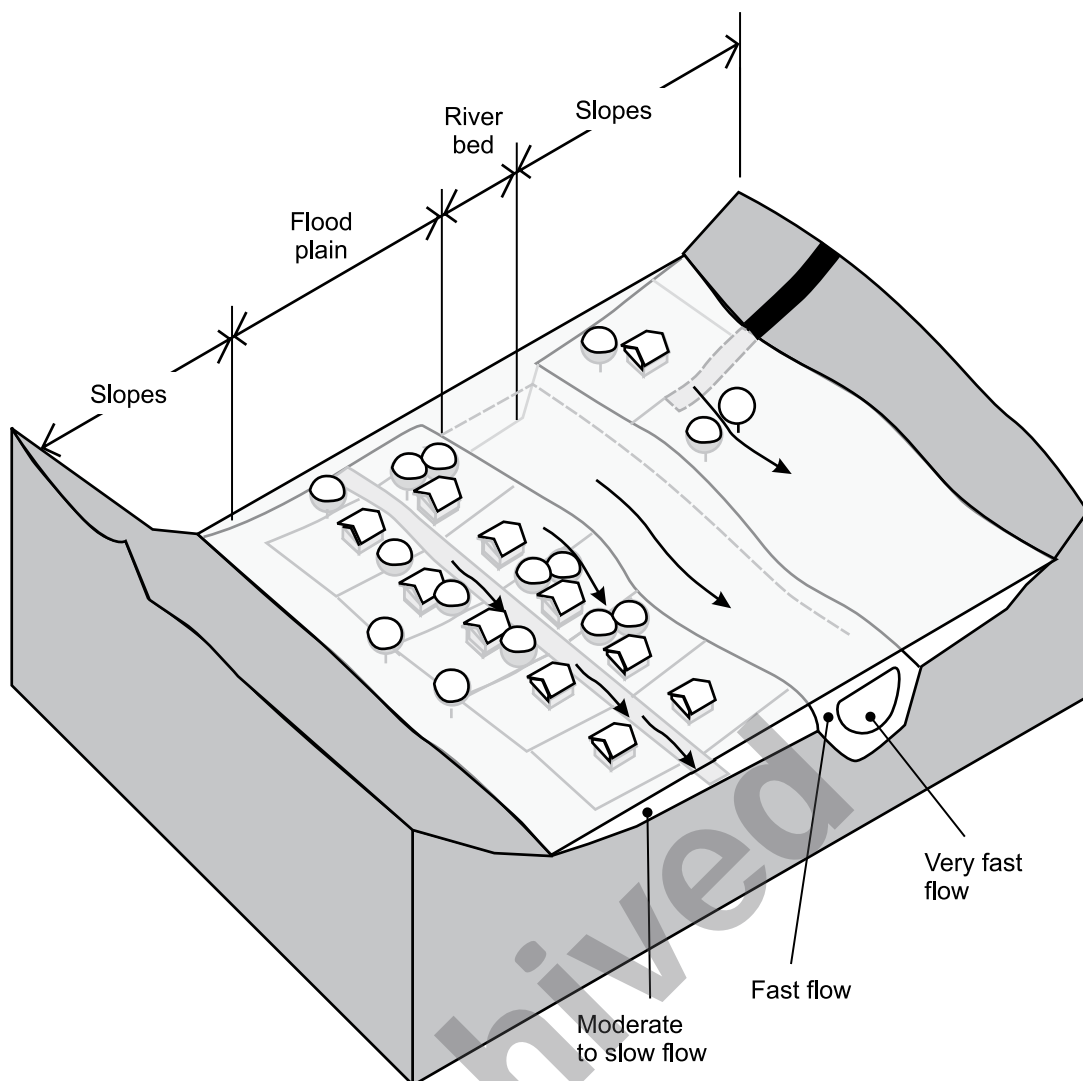

Figure 9:1
Rivers in flood cross section

9.2 River hazards

Any river feature that poses a threat to life, limb or navigation is a hazard and should be treated with caution. Remember to **stop and take 5**.

9.2.1 River currents

A flooded river does not have a uniform water speed, nor does all the water flow downstream. There are two types of currents:

- **laminar flow**—laminar flow accounts for most of the water flowing downstream. It is a layered flow of water in which the slower layers push against the banks and bottom. The fastest layers are on top and in midstream.
- **helical flow**—helical flow is water along the banks. It is a corkscrew motion downstream that tends to push floating objects towards midcurrent.

The friction of the water against the banks causes the water next to them to flow in a corkscrew motion downstream between the bank and the main current. The main current flows downstream in a laminar (layered) fashion, with different layers of water moving at different speeds. Friction from the bottom and sides of the river slow the outer layers of water, so the fastest water is usually found just below the surface in the centre of the river.

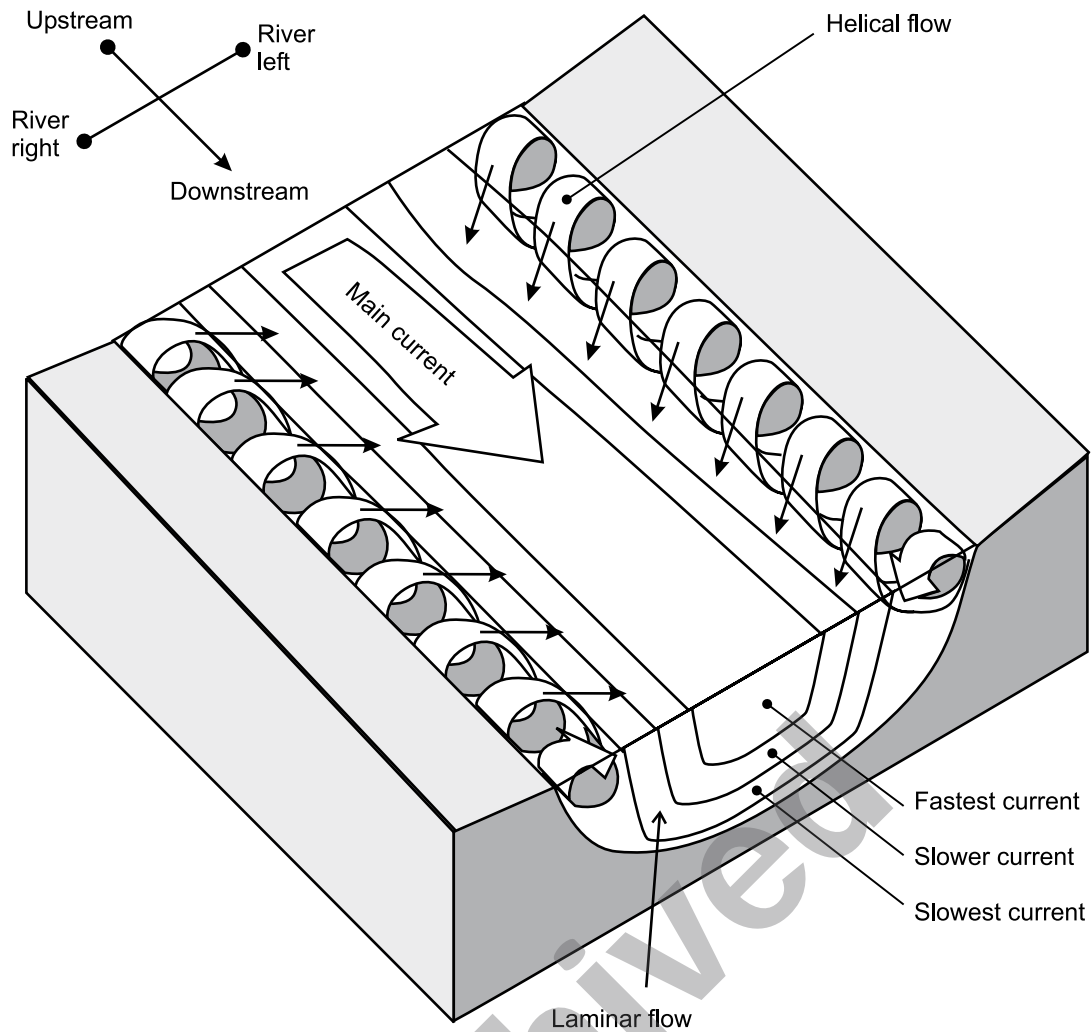

Figure 9:2
River currents

Much of the character of a river comes from the type of river bed it runs across. Much of what happens on the surface is determined by what is beneath.

The main current of a river does not flow straight down the middle, but meanders from side to side and up and down. As a river bends, the fastest current tends to move to the outside of the bend, while the water on the inside of the bend slows. This causes the typical river bend: deep, with a faster current on the outside, shallow and slow on the inside. The up-and-down meandering of the current is caused by changing depth, still pools and shallow, swift spots. Rapids may be encountered on the shallow, fast-moving sections of rivers.

When travelling in a FRB, river right and left are always as viewed looking downstream.

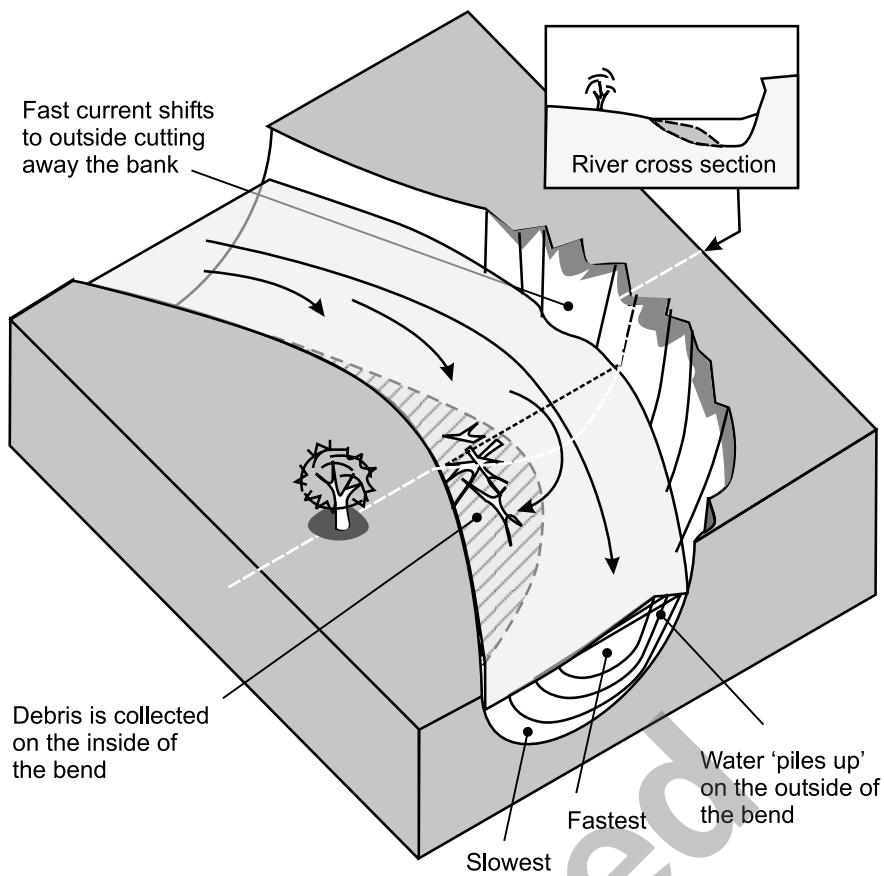

Figure 9:3
River bend cross-section

Current differentials occur when streams converge or the shoreline changes.

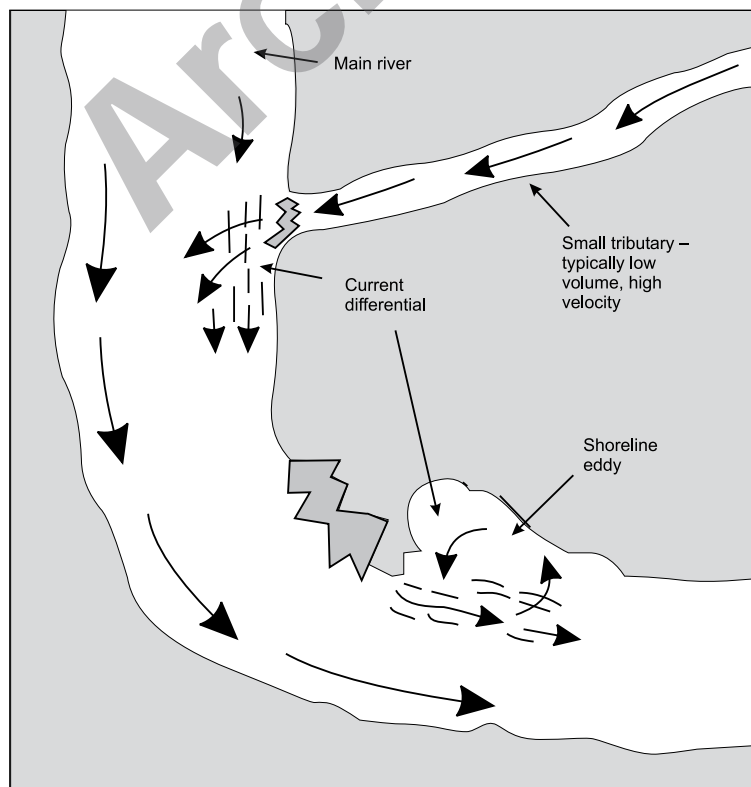

Figure 9:4
Current differentials

9.2.2 Debris

In most floods there is a huge amount of debris, which can be a problem if the FRB hits it or it hits the FRB. Some debris can be big, solid and very dangerous (eg cars, parts of buildings, gas bottles, trees, logs and drums). FRB crews should keep a good lookout and be prepared to take evasive action.

The work load for the coxswain and lookout is high because of the amount of debris to dodge. Drivers will need to practise steering and using power boldly.

A river carries debris in three ways:

- **top load**—a top load is anything that floats, whether it is a boat or a piece of debris
- **suspended load**—the suspended load is carried inside the river, neither floating nor touching the bottom—these loads can be fine sand/soil or larger and heavier objects
- **bottom load**—bottom loads are those things that are too heavy to suspend, such as rocks or submerged cars, which move along the bottom, pushed by the current.

As a river begins to flood it picks up more of each type of load. As the flood recedes it will begin to drop the load it carries.

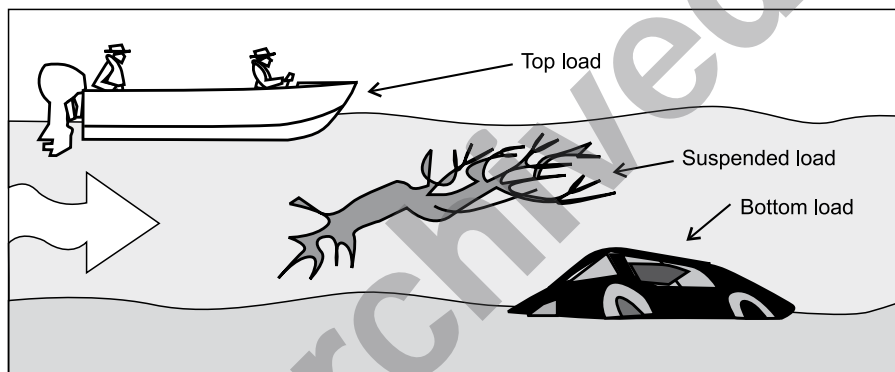

Figure 9:5
Flood debris

9.2.3 River waves

River waves can be caused by many things but the main causes are:

- a fast-moving current entering a slower section of the river
- a sudden restriction or change in the river's cross-section or gradient
- water flowing over a submerged obstacle
- the current hitting a hard obstacle like a boulder or bank
- converging currents (eg two rivers joining)
- colliding currents (eg a river current meeting a tidal current).

The effect of the obstruction is modified by many factors, including water depth and speed.

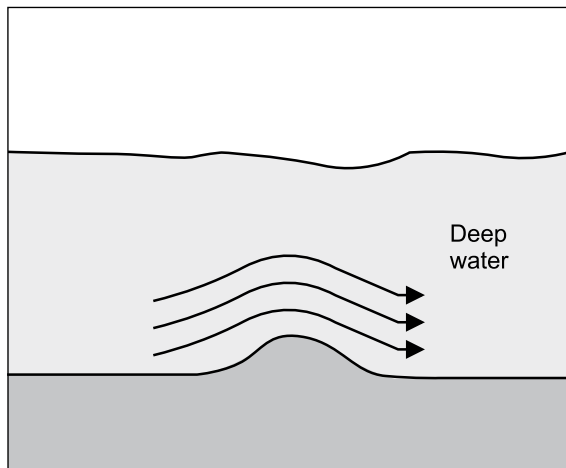

Figure 9:6a

River waves

Early in the day when the floodwater was high this underwater object was no obstacle (deep obstruction).

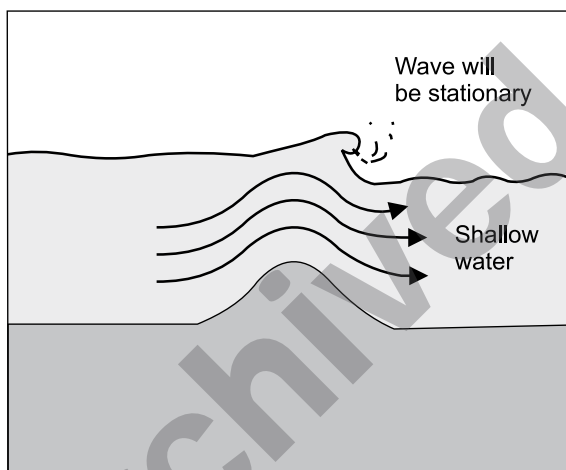

Figure 9:6b

River waves

Through the day the water level dropped, causing a hazardous stationary wave above the object (shallow obstruction).

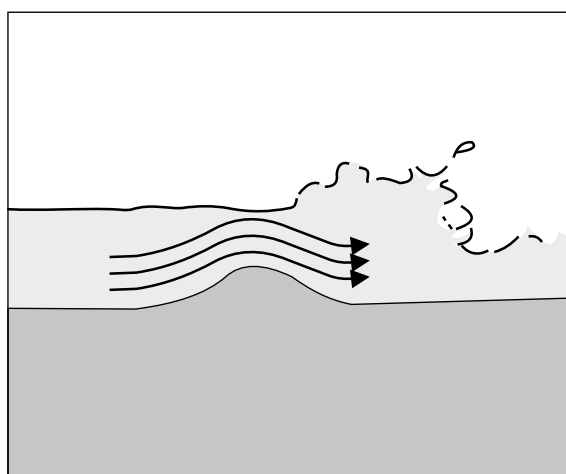

Figure 9:6c

River waves

Late in the day the same underwater object became a dangerous rapid (shallower obstruction).

9.2.4 Water curl back

Fast-flowing water moving across a large obstacle may cause the water to curl back on the downstream side of the obstacle.

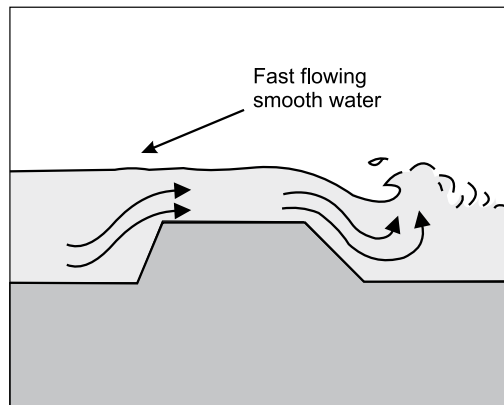

Figure 9:7
Curl back

9.2.5 Eddies

Not all water flows downstream. Looking at a flooded river, this may seem absurd but the faster the downstream current, the more powerful the upstream currents become.

The most common upstream flow is an eddy. As water flows past an obstacle like a boulder, several things happen. First, a reaction called a **pillow** forms as water piles up on the upstream side of the obstacle. The pillow forms a cushion that tends to push floating objects away from it. Second, while water piles up higher than the river level on the upstream side of the obstacle, the water on the downstream side is lower, so water flows around the obstacle and then back towards it to fill the low spot. This upstream current is called an eddy. Eddies form behind midstream obstacles and along banks. Eddies can be very useful for boat handling and rescue as they offer a place to get out of the main current (see Figure 9:4).

On larger rivers there may be a substantial height difference, called an eddy fence or wall, between an eddy and the main current. Big rivers may also have extremely turbulent eddy lines full of whirlpools that randomly form and dissipate. Instead of being a safe haven, the surging eddies of a big river can be very hazardous.

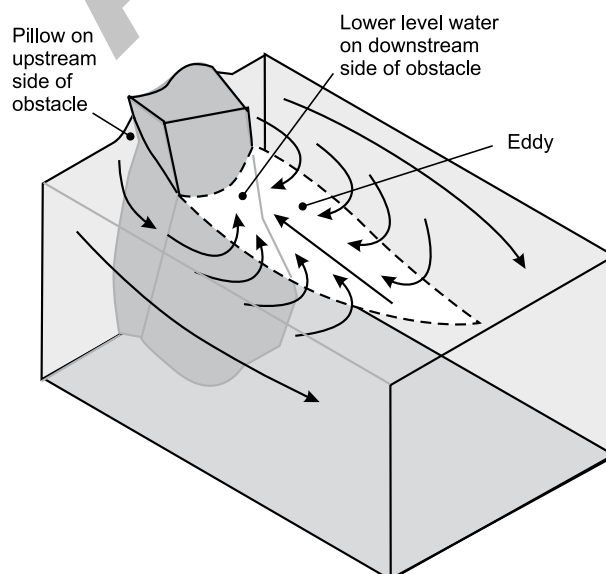

Figure 9:8
Eddies

9.2.6 Hydraulics and holes/stoppers

Hydraulics and holes are formed when water flows over underwater obstacles.

A recirculating current is formed as the water dives down behind the obstacle and back upstream. The water behind hydraulics is usually aerated and has a white, foamy appearance. The aerated area of water where the recirculating current rises is called the boil line (Figure 9:9a).

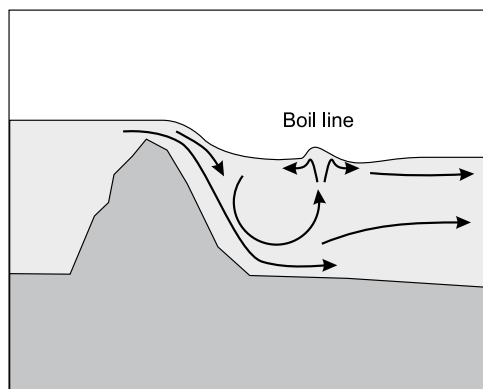

Figure 9:9a

Hydraulics and stoppers - Current first flows over the top of the obstacle

As the water deepens, the hydraulic is replaced by a standing wave, which breaks back upstream (Figure 9:9b). These are sometimes known as holes. As the water deepens further, the waves stop breaking and become smaller (Figure 9:9c).

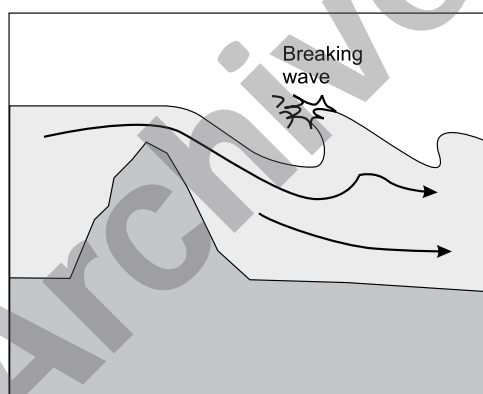

Figure 9:9b

Hydraulics and stoppers - Current deepens

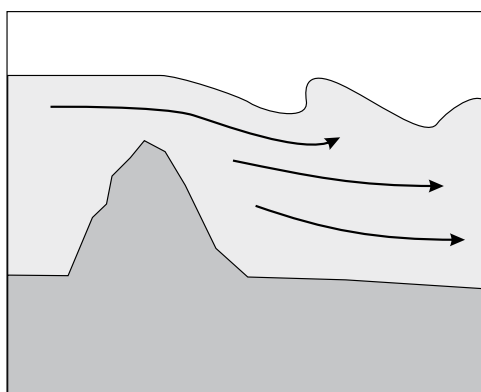

Figure 9:9c

Hydraulics and stoppers - Current deepens more

A standing wave that breaks upstream can hold a boat or object for some time (Figure 9:10a). However, once submerged, the main current will take an object downstream quickly (Figure 9:10b).

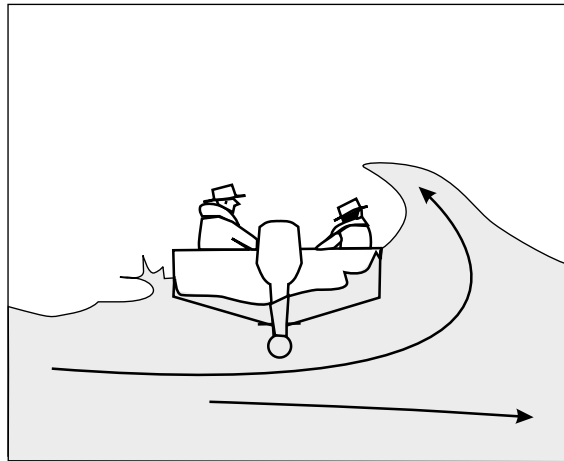

Figure 9:10a
Standing waves

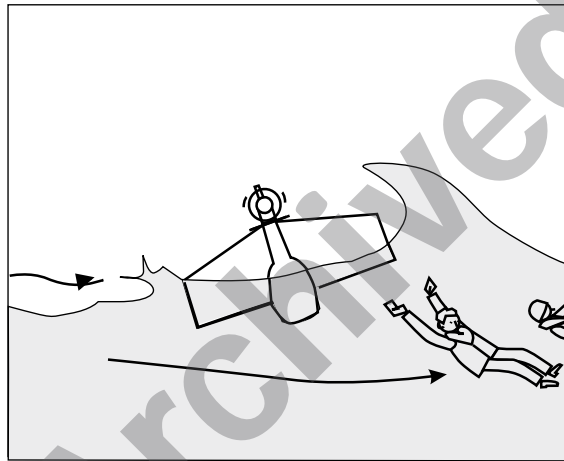

Figure 9:10b
Standing waves

Hydraulics, on the other hand, can hold both floating and submerged objects in the recirculating current (Figure 9:10c).

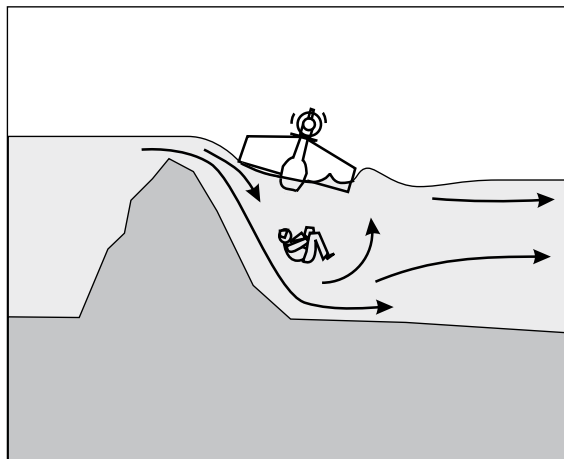

Figure 9:10c
Standing waves

9.2.7 Smiling and frowning holes/stoppers

Natural hydraulics usually come in two forms:

- **smiling**—a smiling hydraulic has its outer edges curving downstream, so the recirculating water (and anything caught in it) feeds out into the main current
- **frowning**—in a frowning hydraulic, the outer edges curve upstream, feeding the water flow into the centre of the hydraulic. These are the most dangerous and should be avoided.

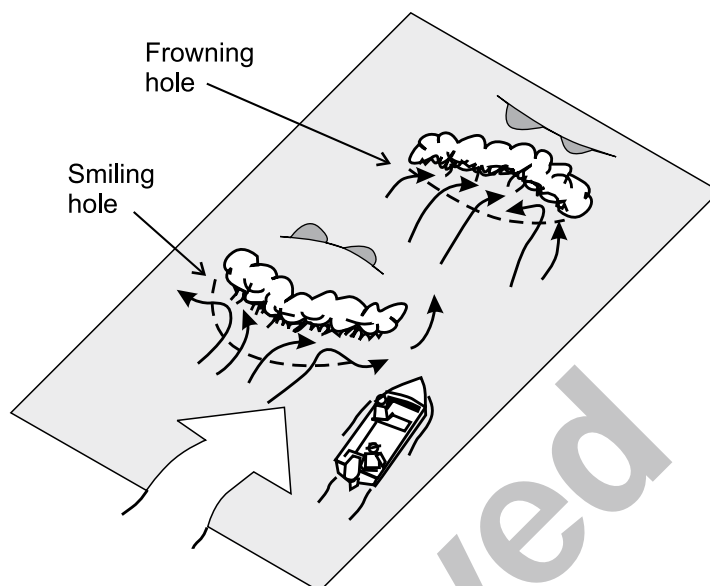

Figure 9:11

Smiling/frown holes and stoppers

9.2.8 Whirlpools

Whirlpools are currents around banks or structures.

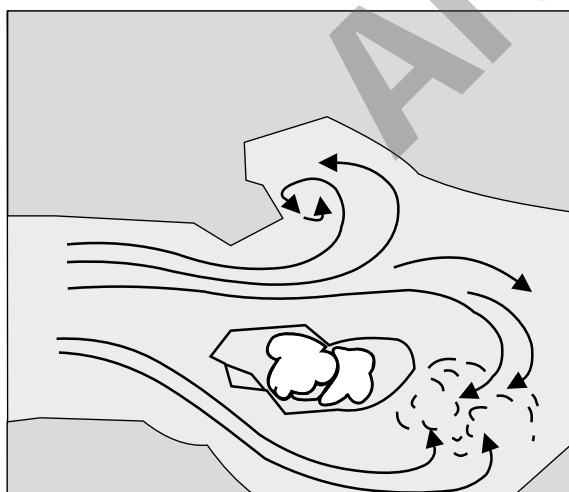

Figure 9:12a

Whirlpools

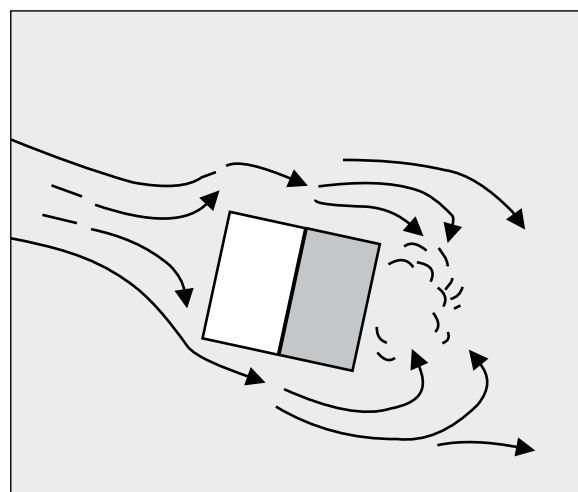

Figure 9:12b

Whirlpools

9.2.9 Rapids

Rapids are caused when fast-flowing water is restricted, obstructed or travelling down a steep bed slope.

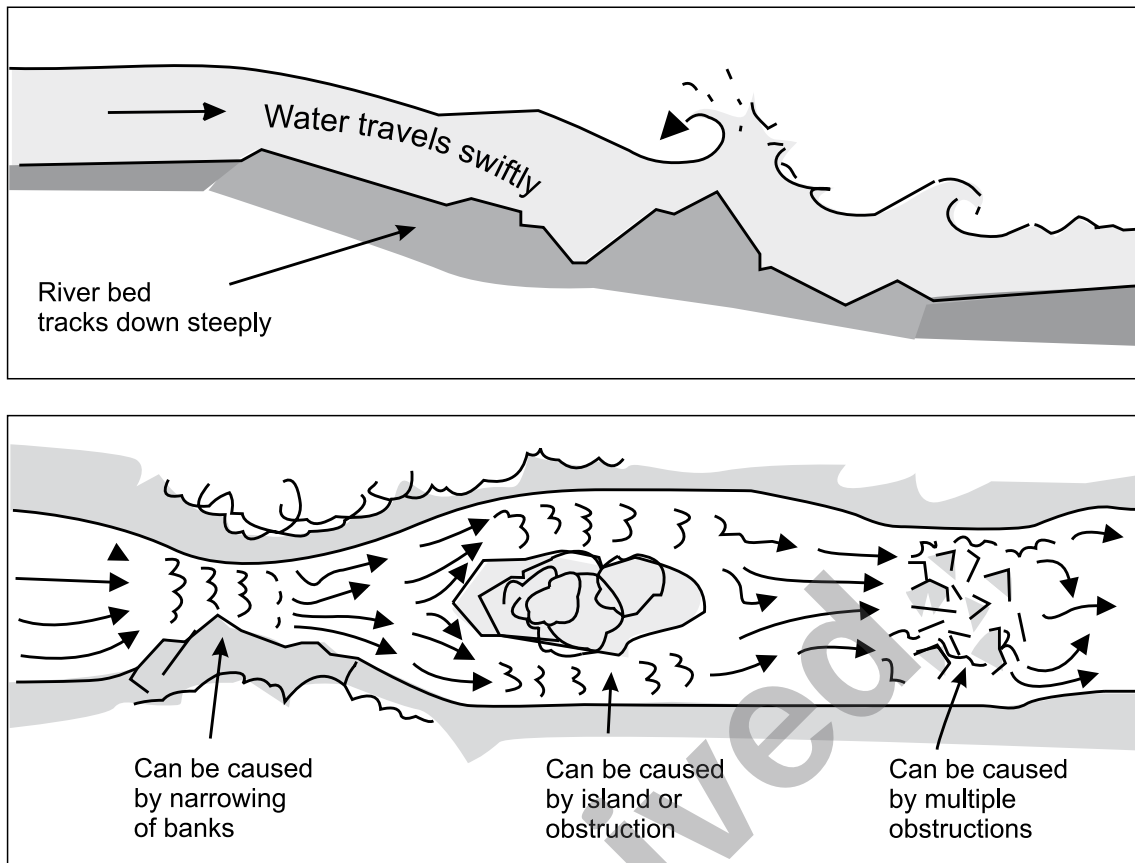

Figure 9:13
Rapids

9.2.10 Weirs

A common hydraulic is a weir (also called a low head dam). These usually appear as a uniform feature across a river. They are difficult to see from upstream and very difficult to escape from without help.

Weirs are recognised by the presence of a boil line. The boil line is where the backwash (water flowing back upstream) meets the outwash (water flowing downstream).

The water in the backwash is normally frothy, aerated and white. The water in the outwash is darker and smooth.

Do not go over weirs unless it cannot be avoided.

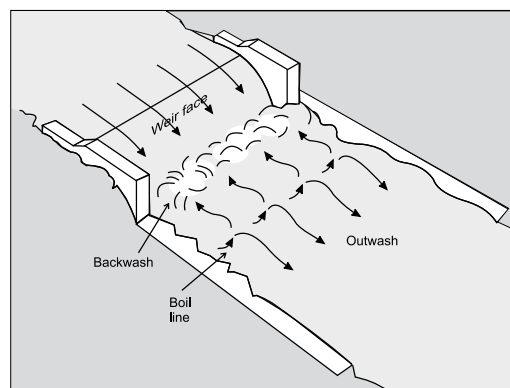

Figure 9:14a
Weirs

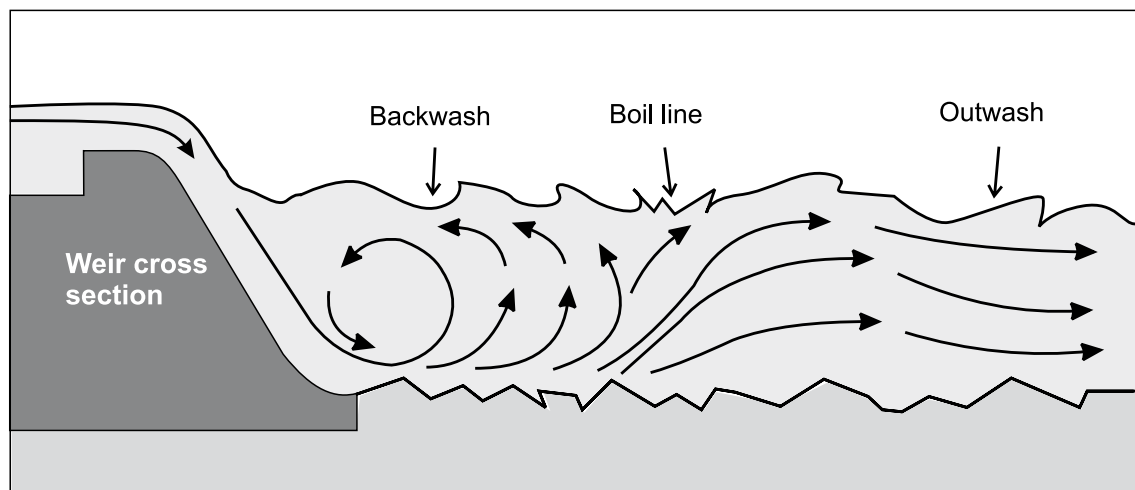

Figure 9:14b
Weirs

WARNING

If the FRB or a person gets caught in a boil line, they will lose buoyancy due to the water aeration and have a tendency to be rolled over continuously.

9.2.11 Strainers

Anything that allows water but not solids to pass through it is called a **strainer**. The most common strainers are fallen trees, fences and guard rails. The force of the current holds solid objects against the strainer. Boulder and debris piles can also act as strainers.

9.2.12 Bridges

Unlike natural rocks and boulders, which usually cause an upstream pillow, bridges usually have little hydraulic cushioning. Consequently, bridges are often the site of boat and raft pinning. They frequently collect debris piles on the upstream side, causing lethal strainers.

9.3 Working in currents

9.3.1 A typical river in flood

Rocks and debris washed down by side creeks obstruct the river at a ford. The water above the ford backs up, forming a large, deep pool. Above each obstruction is a small reaction called an **upstream 'V'**, which signals the presence of an obstruction, even if it is under water.

Where the water flows between the obstructions, a 'V' shape is formed pointing downstream, called a **downstream 'V'**. This feature usually indicates where the deepest water flows. Large downstream 'V's, where they rise above the level of the surrounding water, are known as **chutes**. Often at the bottom of the larger downstream 'V's **standing waves** form.

A large, submerged boulder in the flow causes a hole. Some of the downstream 'V's are blocked by debris, forming strainers. Behind each obstruction and along the bank are eddies. The rocks on the right cause a boulder sieve. Where the banks constrict the river's flow below this rapid, there is another series of standing waves. Here the river picks up speed in the constriction, then gives up energy in the form of waves when it hits the slower water below it.

If there is a break or irregularity in a series of standing waves, it is probably caused by an underwater obstacle like a rock.

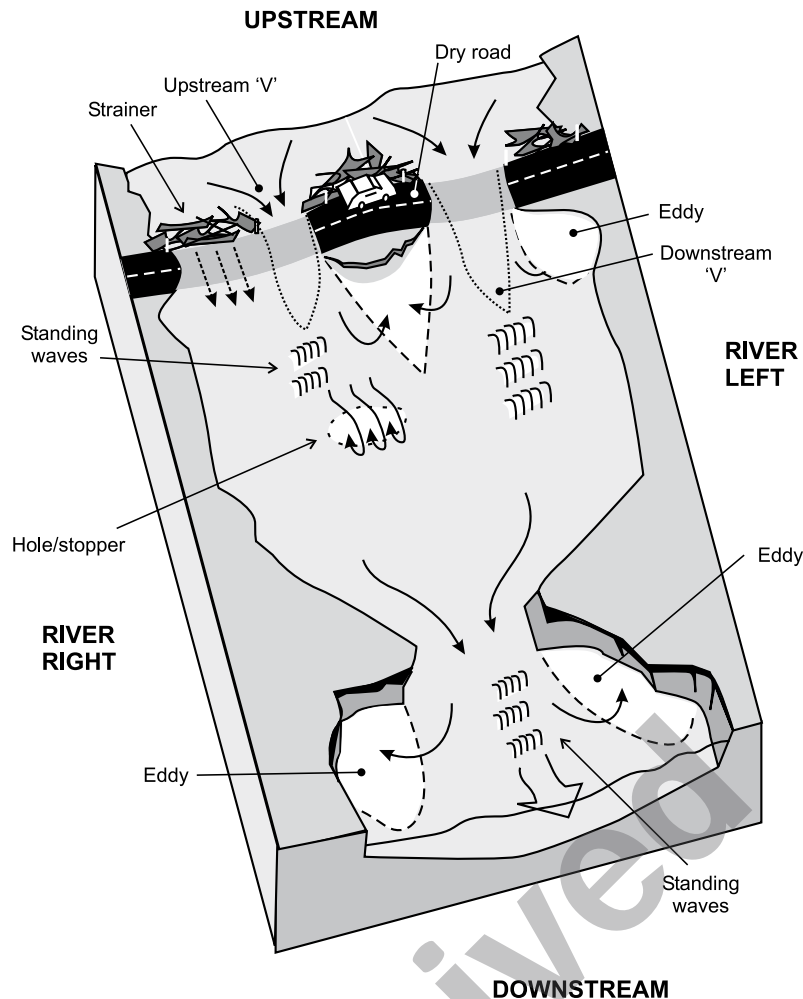

Figure 9:15
Flooded river/causeway

9.3.2 Getting started in a current

In faster currents a FRB may not be able to get onto the plane easily. This does not mean it is not possible to go upstream, but it does mean the FRB crew needs to think about how to get the FRB up and planing. Some techniques are:

- a. Make sure the appropriate propeller is fitted. Flood conditions require power, not top-end speed, so fit a lower pitch propeller (a lower gear) than normally used on flat, still water.
- b. Trim the motor fully in and have the crew move forward in the FRB. Keeping the bow down will help the FRB get out of the hole quicker. Once out of the hole, trim the motor out and move the crew towards the stern till the FRB is trimmed and running efficiently.
- c. If there is room and water depth, run downstream until on the plane, then turn as wide an arc as possible until the FRB is running upstream. Remember to trim the motor out once on the plane so the FRB is running as efficiently as possible before turning into the current.
- d. Try using an eddy to your advantage, as the water in eddies flows in the opposite direction of the current. This is known as an **eddy turn** (see section 9.3.6).

9.3.3 Travelling in currents

Steering a FRB in a current requires forward motion when heading up or downstream. FRBs are much more manoeuvrable when travelling against the current.

Upstream travel against currents is possible in powered boats and is the safest direction in which to travel, as the water passing the bow enables the coxswain to maintain steerage and control even at very low speeds. The biggest limitation of upstream travel is power: at some stage even the most powerful boat will struggle to make way against the current. Before commencing an operation in an upstream current, consider:

- choosing the best FRB for the operation—small flat bottom or shallow V-hull boats that are well powered will do this job best
- minimising the load, equipment and crew, which will help achieve the best power-to-weight ratio
- changing to a lower pitch propeller
- limiting upstream travel by launching as close to the operation as practicable
- launching upstream of the operation and travelling downstream
- ensuring there is enough fuel, as travelling against a current increases fuel consumption.



Figure 9:16
Upstream travel

Downstream travel is much easier on the engine than upstream travel and enables more weight to be carried, but it is more dangerous than upstream travel. While the boat is travelling faster than the current, the boat will be easy to steer and control; however, when the boat is moving at the speed of the current or less, it will have little or no steerage and will be hard to control. The boat will also be hard to stop using reverse gear, as propellers are designed for maximum efficiency when running forward and are very inefficient in reverse. Before commencing an operation in a downstream current, consider:

- choosing the best FRB for the operation, remembering that at some stage there may be a need to travel back upstream to return or to complete another operation
- determining the appropriate load, equipment and crew—more weight can be carried when travelling downstream but do not overload the FRB and maintain a good power-to-weight ratio: crew members never know what may be around the bend
- limiting downstream travel by launching as close to the operation as practicable
- launching downstream of the operation and travelling upstream.

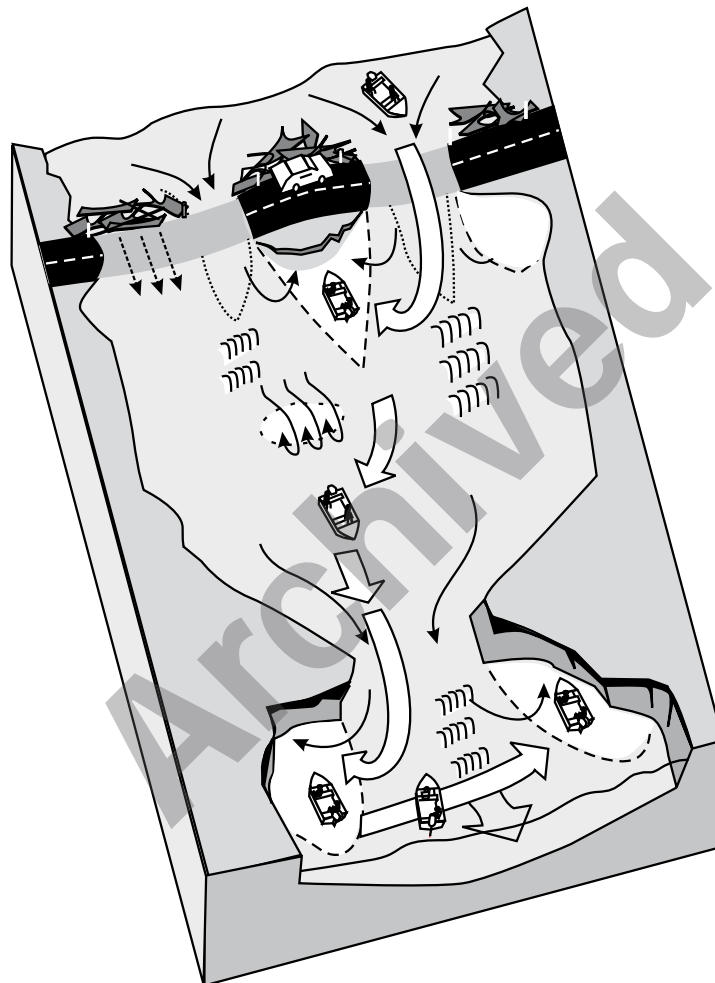

Figure 9:17
Downstream travel

9.3.4 Finding a route

It is very important for a FRB crew to plan a route when travelling on flooded rivers, in particular when confronted with obstacles like rapids, bridges, floodways and shallow water. Crews should stop and assess the obstacle before attempting to pass it. Start the assessment by considering the destination. Identify the best route back to where the FRB is.

Remember: the deepest, smoothest water will usually be marked by a downstream 'V'.

In the example in Figure 9:18, the obstacle is the road ford, and the FRB crew would like to end up close to mid-river, downstream of the standing waves. The centre downstream 'V' or chute is the only safe passage, as the other downstream 'V's are either too small or blocked by debris. The centre chute is wide and open but a hole downstream to the right needs to be avoided. If the standing waves are large, the crew may plan to turn out of the chute a little early to avoid them.

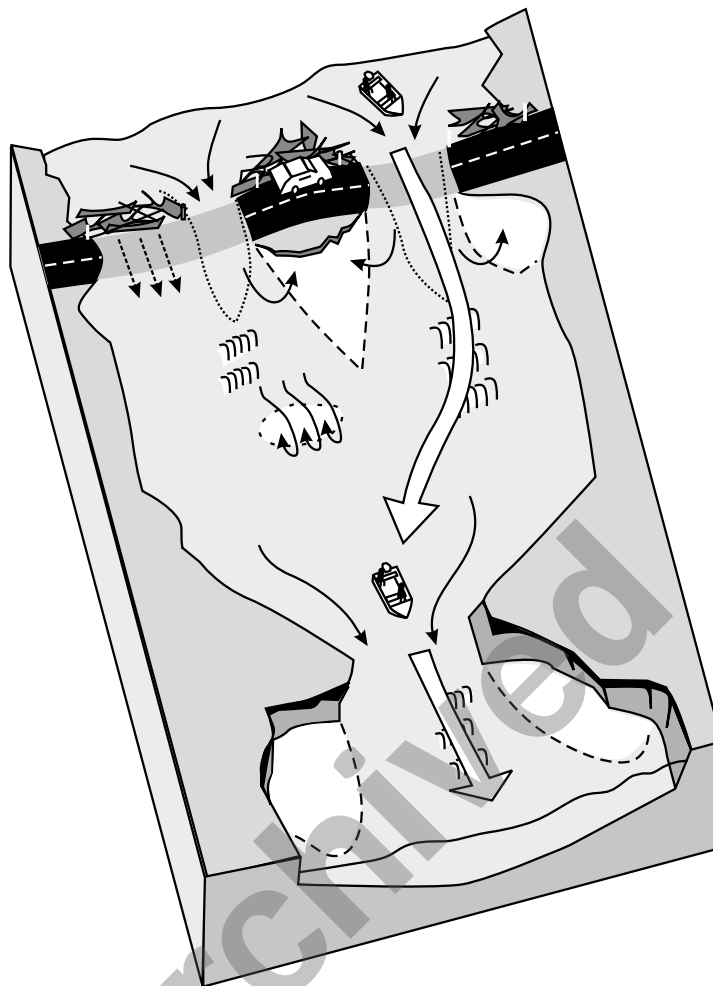

Figure 9:18
Route finding

9.3.5 Turning in currents

Turning is easy when running upstream, as the current passing the boat will help the boat to turn. As long as the bow is facing into the current, the boat will respond to the helm under power, even at low speeds.

When travelling downstream at speeds well in excess of the current, turning the boat is not a problem, although the boat's turning radius will be greater than on still water.

Turning at speeds close to the current's speed is difficult, as the force of the water works against the boat. The coxswain needs to be confident and use positive and sharp throttle bursts to help the boat turn. The crew members can shift their weight to the side they want the boat to go, which also helps downstream turns.

Remember: the boat hull type and load will also affect the boat's turning responsiveness.

9.3.6 Eddy turns (breaking in)

In an eddy turn, a boat in the main current turns into an eddy. Eddies are used as safe havens, where a boat's upstream or downstream progress can be interrupted. The boundaries of an eddy tend to push objects away from it. Therefore, any boat trying to enter must do so with some speed in order to punch through the eddy line. FRB crews must also be aware that the current reverses direction when crossing an eddy line, and they must be prepared to either lean the boat or shift their weight accordingly.

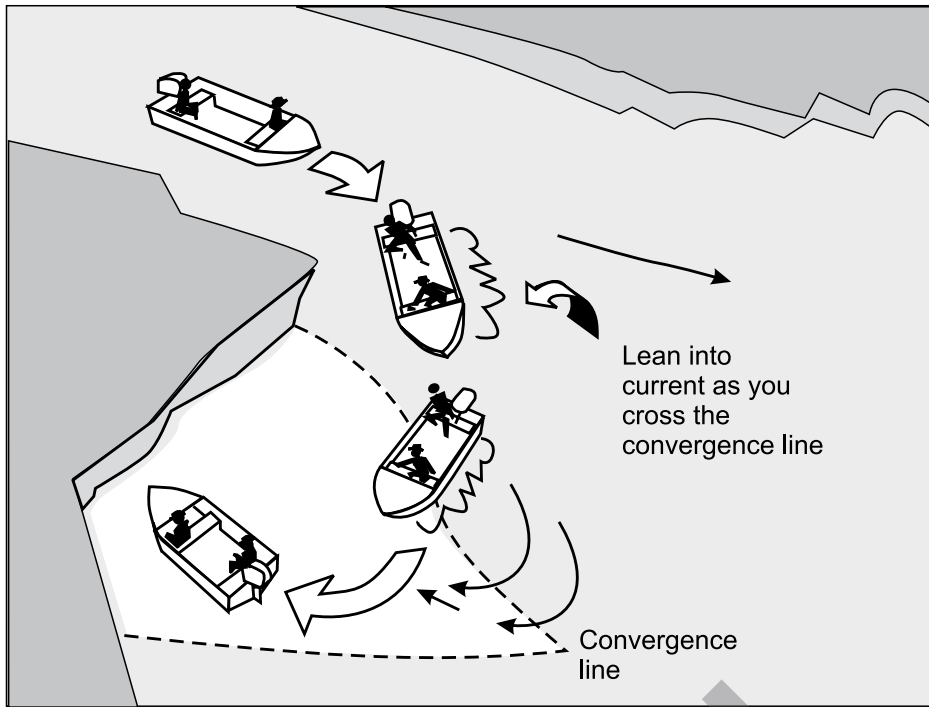

Figure 9:19
Eddy turns

9.3.7 Eddy peel out turns (breaking out)

In a peel out, a boat in an eddy goes out into the main current. Many of the same factors apply as in an eddy turn—particularly, the need for speed when crossing the eddy line and the downstream lean or weight shift.

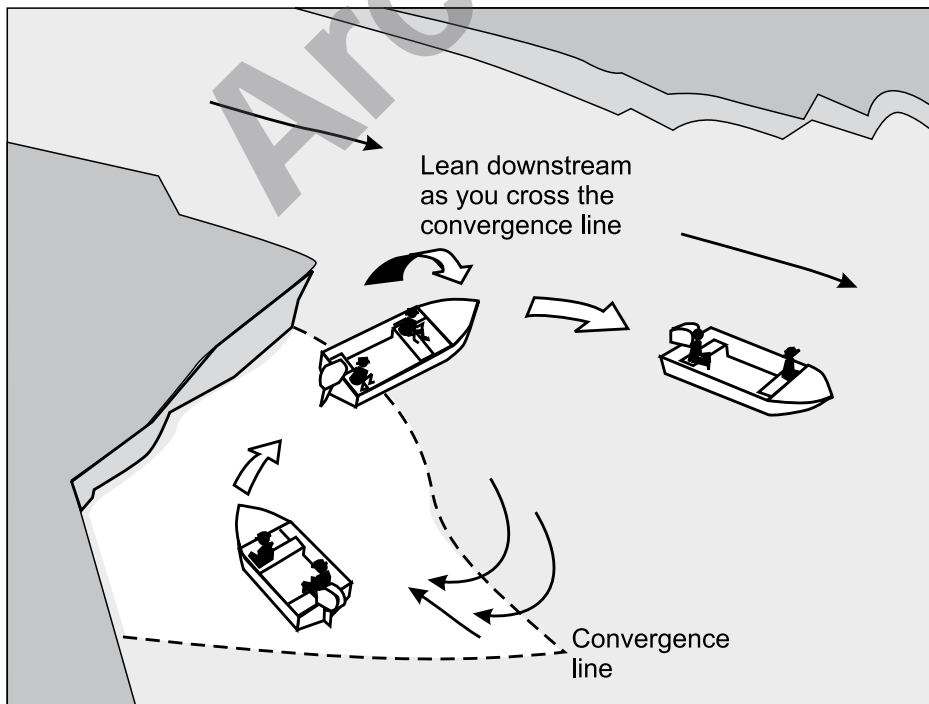

Figure 9:20
Peel out turns

9.3.8 Crossing currents (ferry angle or ferry glide)

Crossing a fast-flowing stream can be dangerous. Given that FRBs have more manoeuvrability when travelling upstream, it is best to cross using the **ferry angle** technique. This allows a boat to cross the current without losing position.

To cross a current using the ferry angle technique:

- set the FRB at an angle to the current while the motor is in forward gear
- the resulting interaction of forces pushes the boat sideways across the river
- the amount of throttle required depends on the boat, the load and the force of the current.

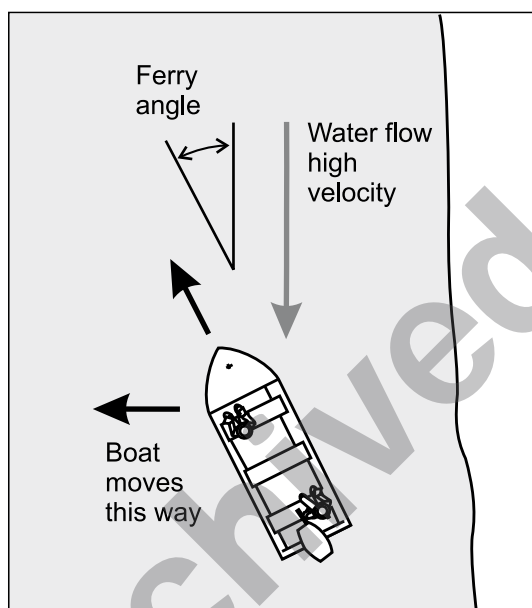

Figure 9:21

Ferry angle

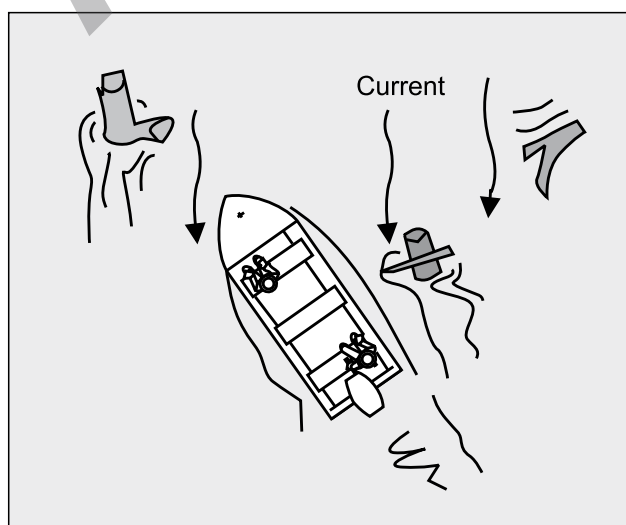

Figure 9:22

Angle across the current, watching for debris

9.3.9 Stopping in currents

At times the FRB crew may be required to stop the FRB to assess a hazard, avoid debris or recover a person. Stopping in a current is difficult because the force of the water will not let up and will continue to push the FRB along. Travelling upstream is less of a problem because the coxswain can use engine power to hold a position, but even this needs skilled throttle control. If a FRB needs to stop while travelling downstream, the crew has two options:

- a. Turn the FRB around and hold it under power with the bow pointing upstream.
- a. Find an eddy and move into it using the eddy turn technique.

Note: avoid trying to stop the FRB using reverse gear while travelling downstream. The current may push water over the transom and swamp the boat.

9.3.10 Beaching in currents

Beaching in a current is not recommended. It is better to find a protected area of the shore, such as a shoreline eddy, and beach the FRB there. However, if there is no other option but to beach in a current, always try and do so while running upstream. This way the coxswain will be able to control the beaching by driving the FRB all the way to the shore.

Remember: trim the motor out as needed (to avoid propeller damage) and be ready with a bow line to secure the FRB to the bank.

9.3.11 High siding

When working in currents the FRB may high side if pinned against a bridge pylon or if a large standing wave is hit beam on. Act quickly in either of these situations to avoid being capsized. To stop being capsized, follow the steps illustrated below.

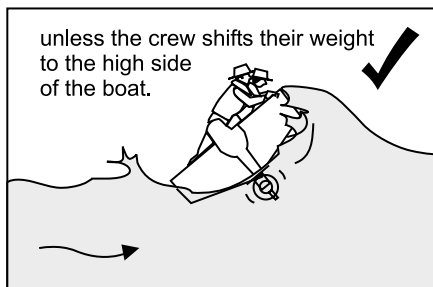
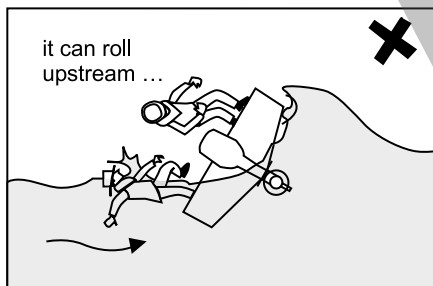
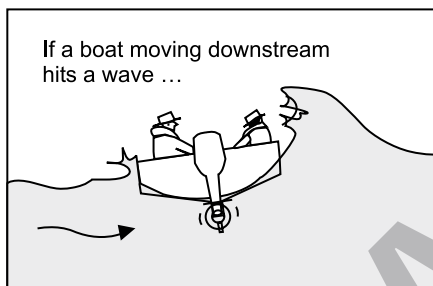

Figure 9:23a
High siding

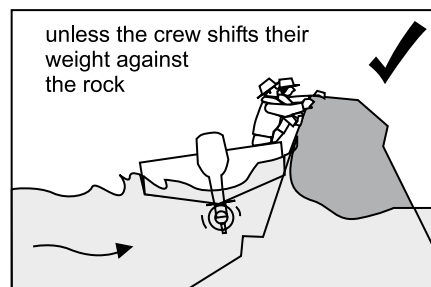
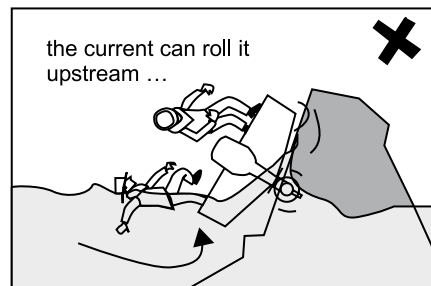
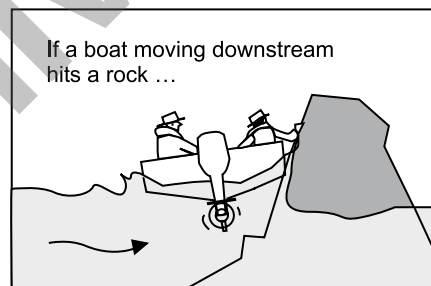

Figure 9:23b
High siding

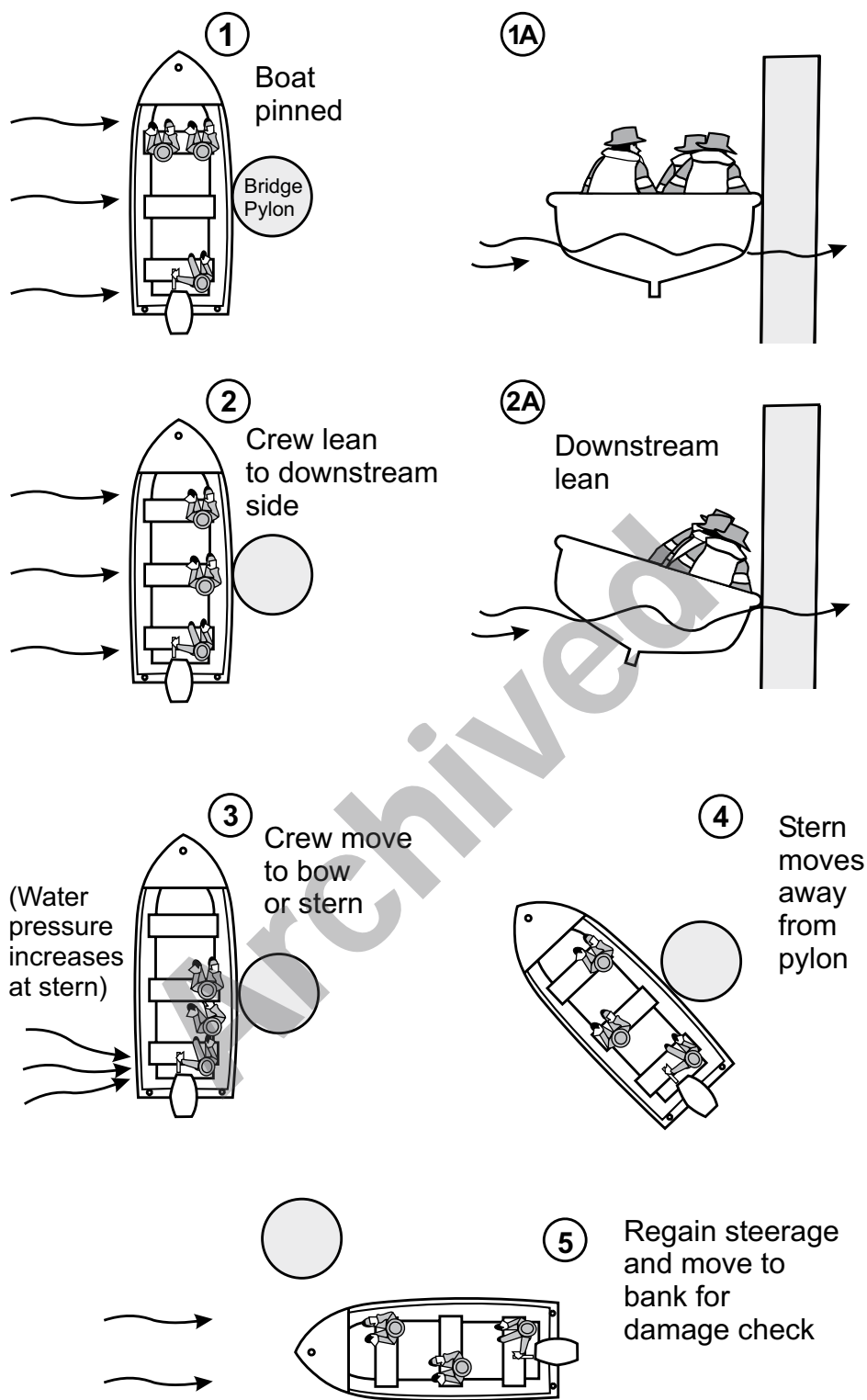

Figure 9:24
Pinning

9.3.12 Crossing a weir

Crossing a weir is not recommended. It is extremely dangerous and should only be attempted in emergency situations by very experienced boat operators. Most dams and weirs will not have enough water running over them to allow keel and propeller clearance. Even if they do, they are only passable while travelling downstream.

Eliminate the hazard by launching the FRB on the downstream side or approach the operation from another direction. If this cannot be done, the FRB crew should plan to carry the boat around the hazard. This means the crew will need to take a small, portable FRB.

If no other option is available and the person in command plans to cross a weir, it is important to:

- **stop and take 5**
- assess the hazard and plan the safest route
- fully brief the crew
- prepare the FRB
- approach the weir at a speed that will provide enough momentum to clear the hazard
- trim the motor out to lift the bow and provide propeller clearance
- when the boat is over the weir and in the backwash, accelerate hard and trim down to clear the boil line.

Remember: a propeller will not perform efficiently in the aerated water in the boil line.

9.3.13 Approaching objects in flood

It is important to plan the best way to approach submerged or floating objects in flood situations. When approaching objects in flood waters, approach from downstream where possible, stemming the current to help maintain a safe approach speed and steerage.

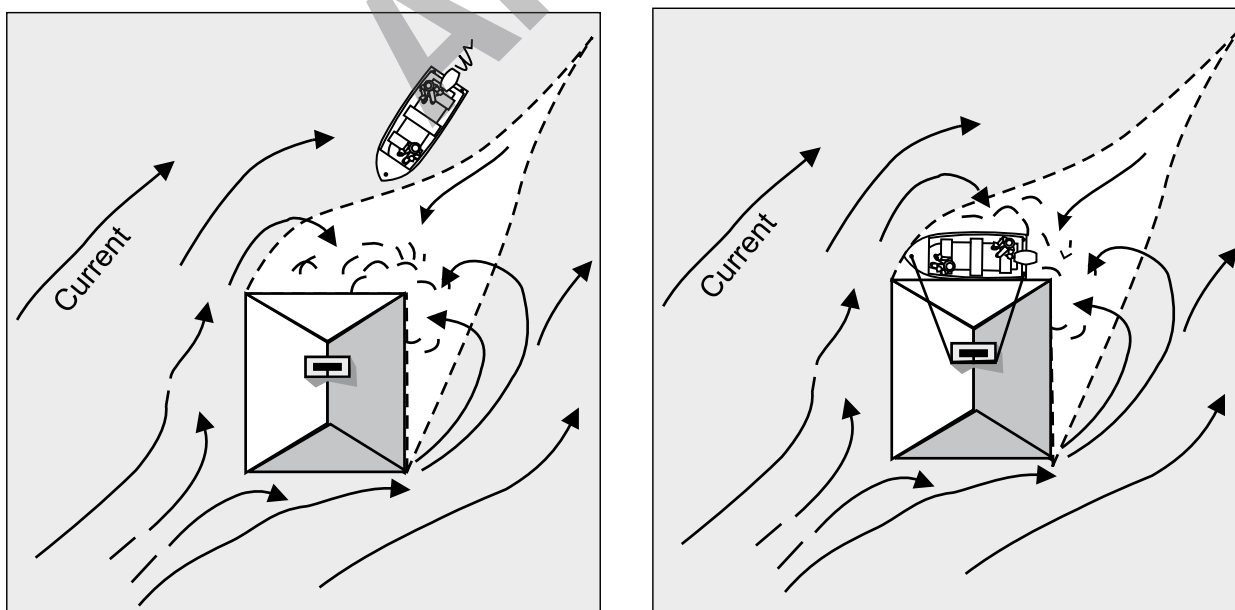

Figure 9:25
Approaching a submerged house

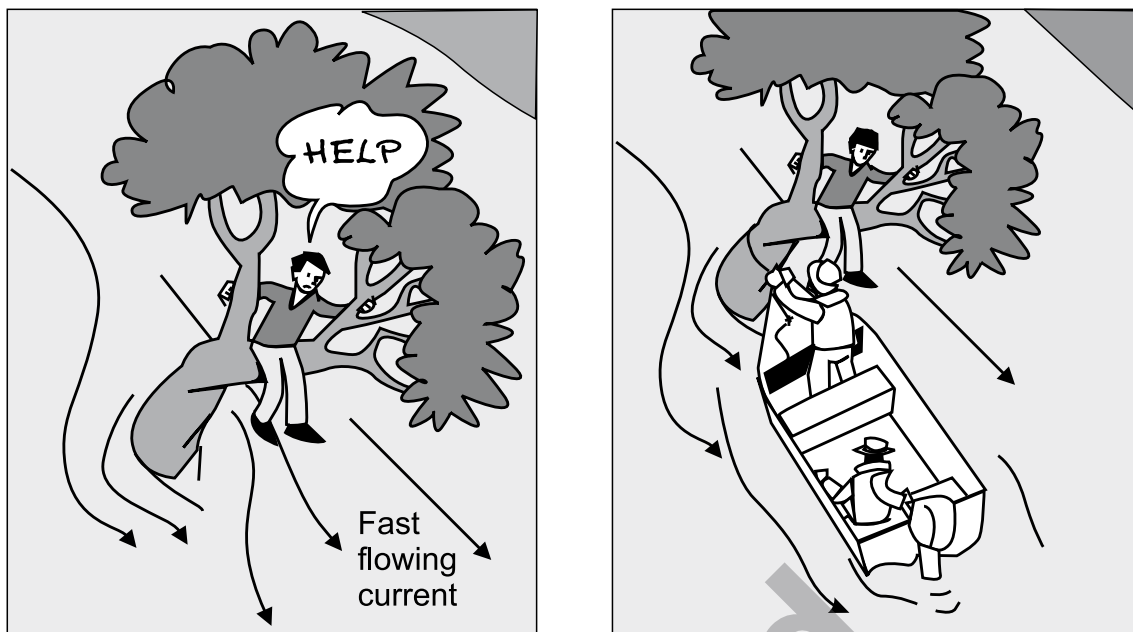

Figure 9:26
Approaching a tree

Archived

End of chapter. This page left intentionally blank.

Archived

CHAPTER 10

Navigation

The ability to navigate inland or estuarine waters is an essential skill for all FRB crews. FRB crews must be able to:

- plan a journey nominating courses, distances and timings
- navigate while underway.

Map reading and navigation are covered in detail in the Australian Emergency Manual *Map Reading and Navigation*.

10.1 Navigation aids

To navigate a boat a crew member should have a:

- compass
- GPS
- map or chart of the area
- street directory (urban areas)
- watch or stop watch.

10.1.1 Fixed marine compass

The compass should be installed into the boat as per the manufacturer's specifications. A fair degree of accuracy is achievable, but using a hand bearing or a portable compass may be more flexible and just as effective.

The crew should be aware that any compass in a boat will be affected by the metal surrounding it, by the outboard motor and by radios.

10.1.2 Charts

If required for the area of operations, marine charts contain a large amount of information but require some experience and training to use. Information includes water depth in metres, tidal range and streams, and navigational hazards and aids, as well as anchorages. Unlike topographical maps, they contain very limited or no information relating to land features, except those right on the coast.

10.2 Navigation techniques

Two simple techniques can help a crew to navigate:

- map to ground—this technique is simply maintaining your position on a map by identifying features around you with those on the map. For example, using easily identifiable bends in the river, power lines crossing overhead, buildings, roads and bridges to maintain your position on the map.
- direction, distance and time—For example, if a FRB has travelled upriver from a boat ramp for 1.5 hours at an average speed of 10 km/h, it has travelled approximately 15 km. A crew member can then work out the approximate position by determining how far up the river from the boat ramp 15 km is on the map/chart. Other information required may be speed, position, depths and heights.

10.2.1 Time-speed-distance triangle

The following triangle can be used to work out the distance, time and/or speed a journey will take using the simple formula below.

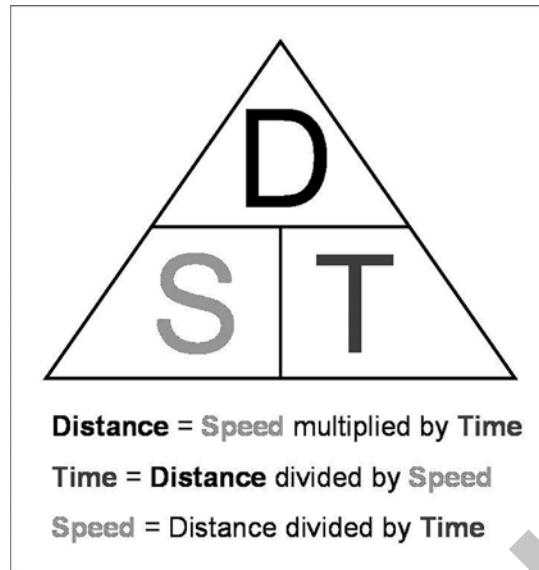

Figure 10:1
Time/speed and distance

For example, to work out how long (time) a boat travelling at 10 knots will take to cover a distance of 12 nautical miles, cover the time segment with a finger and then divide the distance (12) by the speed (10):

$$12 \div 10 = 1.2 \text{ hours}$$

$$0.2 \text{ of an hour} = 12 \text{ minutes } (60 \text{ minutes} \div 10 \times 2)$$

Therefore the time taken will be 1 hour, 12 minutes.

10.2.2 Position

The position of the boat is usually described using one of the following methods.

- Relative coordinates:** the boat's position is described as relative to a certain landmark or navigational aid (eg 'we are about one kilometre south west of Black Rock Lighthouse').
- Geographical coordinates:** these are more precise (eg 'We are 1.2 kilometres, 220 T from Black Rock Lighthouse').
- Longitude and latitude:** this technique is normally used by ocean-going vessels using marine charts.
- Grid references:** as with topographical maps, this is where position is given as a grid reference.

10.2.3 Navigating while underway

Compasses, even those in gimbals, become inaccurate and unreadable at high speed or in choppy waters. It is therefore necessary when navigating to limit speeds so that the compass is readable. However, if higher speeds are required, crew members should use the following method to plot and follow a course:

- plot the course at a slow speed
- line the boat up on the bearing with a point of land at day or a star/light at night
- speed can then be increased and maintained until a new mark is required, when the process is repeated.

This is very similar to navigation on land, where an object is picked out and walked to before taking another sighting.

During night operations greater care must be taken when checking marks, remembering that colour-blind crew members will be unable to identify the correct light colour. Do not hesitate to slow down or stop if a transit point does not appear at the estimated time.

Remember: tides, wind and currents may shift the FRB off course, so constant checking of plot with compass sights is required.

Archived

List of shortened forms

EPIRB	electronic position indicating radio beacon
FRB	Flood Rescue Boat
GPS	global positioning system
IRB	inflatable rubber boat
kg	kilogram
km	kilometre
km/h	kilometres per hour
kV	kilovolt
m	metre
mm	millimetre
PFD	personal flotation device
PPE	personal protective equipment
rpm	revolutions per minute
SOP	Standard Operating Procedure

Archived

Terms and definitions

Abeam—at right angles to the fore and aft line of a vessel.

Aboard—inside or on a boat.

Abreast—level with.

Adrift—broken from mooring, at the mercy of wind and tide.

Alongside—side by side.

Amidships—the centre of the vessel, either with reference to the breadth or length.

Angle adjustment pin/rod—this allows the motor to be set at different angles so that the trim of the boat can be varied.

Anti-cavitation plate—the plate positioned above the propeller to prevent cavitation.

Awash—level with the water surface.

Aweigh—when the anchor is broken out of the ground.

Bearing—a direction or in a direction.

Belay—to secure a rope to a cleat or belaying pin. (Also to stop what you are doing.)

Benches—seats that run fore and aft. These may also provide floatation.

Bilge—the inside bottom of the boat adjacent to the keel. The bilge is also the foul water that collects inside a boat's bilges.

Bow—the front of the vessel.

Broaching—when a boat yaws too widely and swings broadside on to a wave.

Broadside—moving sideways.

Bung—the drain plug in the transom.

By the head—when a boat is loaded too heavily forward or the bow lies low down in the water, it is said to be 'down by the head'.

By the stern—when a boat is loaded too heavily aft or the stern lies lower than usual, it is said to be 'down by the stern'.

Cavitation—this is aeration of the water causing loss of propeller drive and efficiency. Aeration is often caused by the motor being fitted so that the propeller operates too close to the surface.

Chine—the turn of the hull where the hull sides join the bottom of the hull.

Clamp screws—these secure the motor by the stern brackets to the transom.

Cleats—fittings to which lines are made fast. Some boats may be fitted with bollards, which perform a similar function.

Drag—a boat is said to be 'dragging' when the anchor/s are not holding.

Draught—depth below water line of the lowest portion of the boat and motor.

Electrolysis—this is a chemical process that occurs when two different (dissimilar) metals are in contact, either physically or electrically. One of the metals will corrode at an accelerated rate.

Exhaust relief—the two holes in the shaft below the pump indicator are for dispersal of excessive exhaust fumes.

Foredeck—a small deck at the front of the hull.

Freeboard—height between water line and the gunwale.

Fuel connector—the point at which the fuel line is connected to the motor.

Fuel line—the hose linking the fuel tank to the motor.

Give way—alter course, stop or go astern to avoid a collision.

Gunwale (pronounced *gunnel*)—the continuous strip around the top of the hull.

Headway—moving ahead.

Heel—when a boat lists (or leans) to port or starboard, and is out of trim.

Hull—the main body or shell of the boat.

Keel—the member joining the two halves of the hull bottom, usually along the hull centre line.

Keelson—a reinforcing member to protect the keel and assist in directional stability.

Lee side—sheltered side of a boat.

List—a vessel is said to have a list if it leans to one side.

Make way—beginning to move through the water.

Making leeway—underway and being blown sideways by the wind.

Motor rest—the frame or projections on the motor head allowing the motor to be laid down when removed from the boat.

Motor shaft—the section of motor below the engine, ending at the propeller region.

Painter—a line at the bow of a boat used for making fast.

Port—the left-hand side of a vessel looking towards the bow.

Priming bulb—the bulb on the fuel line used to pump fuel from the tank and inject fuel into the carburettor for starting.

Quarter—the area between abeam and astern.

Rowlocks—the brackets used as pivot points between the hull and the oars.

Shift lever—the gear selection lever for forward, neutral and reverse.

Skeg or skid—provides directional stability and protects the propeller.

Sound—to find the depth of water.

Starboard—the right-hand side of a vessel looking towards the bow.

Steerage way—sufficient speed for steering to be effective.

Stem—the rising or vertical section at the front of the boat where the hull sides meet to form the bow.

Stem the tide or current—using power to hold position against a tide or current.

Stern—the rear or back end of a vessel.

Stern brackets—the brackets for placing the motor on a boat's transom.

Sternway—moving astern (backwards through the water).

Telltale—the outlet, also called a water pump indicator, which allows a steady discharge of water to pass through and which indicates the correct functioning of the cooling system.

Thwarts—the seats built into the hull. Originally those that run across the hull. These often provide flotation and hull structural integrity.

Tiller handle—the arm used for steering and throttle control.

Tilt grip—the grip on the motor cover for tilting the motor forward.

Tilt lock—the lever that allows the motor to tilt or to be locked in position.

Transom—the flat back section of the boat joining the two hull sides to form the stern upon which an outboard motor may be mounted.

Trim—the way a boat sits in the water.

Tuck—the section (often timber) attached to the centre of the transom where the motor is clamped to the hull. It reduces slippage and wear when the motor is fitted.

Twist grip throttle—the moving part on the end of the steering arm to govern the speed of the motor.

Underway—when not at anchor or made fast.

Wake—track or disturbance a boat leaves in the water as a result of its movement.

Warp—the anchor line.

Wash—a wave created by the boat moving through the water.

Water pump indicator—see telltale.

Weather side—the side of the boat facing the wind.

Yawing—to run off course, especially in a following sea.

References and Acknowledgements

The SES National Education and Training Committee (NETC) and Emergency Management Australia (EMA) extend their appreciation and acknowledgment to the following organisations for permission to reproduce material from their publications. The NETC and EMA provide particular thanks to the NSW State Emergency Service for its significant contribution to this manual.

Chapter Reference	Figure Reference	Source Organisation	Publication
Chapter 1	1.1-1.2	New South Wales State Emergency Service	Flood Rescue Boat Operations Learner Guide (2006)
Chapter 2	2.1-2.8, 2.10-2.13, 2.17-2.22, 2.24-2.26	New South Wales State Emergency Service	Flood Rescue Boat Operations Learner Guide (2006)
Chapter 3	3.1-3.7	New South Wales State Emergency Service	Flood Rescue Boat Operations Learner Guide (2006)
Chapter 4	4.1, 4.4-4.5	New South Wales State Emergency Service	Flood Rescue Boat Operations Learner Guide (2006)
Chapter 5	5:1–5:7	New South Wales State Emergency Service	Flood Rescue Boat Operations Learner Guide (2006)
Chapter 6	6:1–6:14, 6:23–6:31	New South Wales State Emergency Service	Flood Rescue Boat Operations Learner Guide (2006)
	6:15-6:19	New South Wales State Emergency Service	General Rescue Learner Guide 2004
Chapter 7	7.1, 7.3-7.12, 7.14-7.15, 7.17-7.20, 7.22-7.26	New South Wales State Emergency Service	Flood Rescue Boat Operations Learner Guide (2006)
Chapter 8	8.1-8.4	New South Wales State Emergency Service	Search Operations Learner Guide (2007)
	8.5-8.11	New South Wales State Emergency Service	Flood Rescue Boat Operations Learner Guide (2006)
Chapter 9	9.1-9.23, 9.25-9.26	New South Wales State Emergency Service	Flood Rescue Boat Operations Learner Guide (2006)

All other images copyright Emergency Management Australia.