



Health Aspects of Chemical, Biological and Radiological Hazards

AUSTRALIAN EMERGENCY MANUALS SERIES

PART III

Emergency Management Practice

Volume 2—Specific Issues

Manual 3

HEALTH ASPECTS OF CHEMICAL, BIOLOGICAL AND RADIOLOGICAL (CBR) HAZARDS

This Manual has been issued in response to a recognised need to have medical information widely available to the health and medical community for the treatment of persons affected by CBR hazards. The authors have used the most current information available, but recognise that some of the medical management procedures contained in the document are still being refined, and have therefore written this Manual as a provisional document. As with all evolving fields, readers should refer to the latest relevant literature for updates.

EMERGENCY MANAGEMENT AUSTRALIA

© Commonwealth of Australia 2000
First published 2000 as a provisional edition

ISBN 0 642 70455 4

Edited and published by Emergency Management Australia

Typeset by Director Defence Publishing Service, Department of Defence

Printed in Australia by National Capital Printing

INFORMATION ON THE AUSTRALIAN EMERGENCY MANUALS SERIES

The first publication in the original AEM Series of mainly skills reference manuals was produced in 1989. In August 1996, on advice from the National Emergency Management Principles and Practice Advisory Group, EMA agreed to expand the AEM Series to include a more comprehensive range of emergency management principles and practice reference publications. The Series is now structured in five parts as set out below.

Parts I to III are issued as bound booklets to State and Territory emergency management organisations and appropriate government departments for further dissemination to approved users including local government. Parts IV and V (skills and training management topics) are issued in loose-leaf (amendable) form to all relevant State agencies through each State and Territory Emergency Service who maintain State distribution/amendment registers. All private and commercial enquiries are referred to EMA as noted at the end of the Foreword on page vii.

AUSTRALIAN EMERGENCY MANUALS SERIES STRUCTURE AND CONTENT

		Publishing Status—Mar 2000
PART I —THE FUNDAMENTALS		
Manual 1	Emergency Management Concepts and Principles (3rd edn)	U/R
Manual 2	Australian Emergency Management Arrangements (6th edn)	A
Manual 3	Australian Emergency Management Glossary	A
Manual 4	Emergency Management Terms Thesaurus	A
PART II —APPROACHES TO EMERGENCY MANAGEMENT		
<i>Volume 1—Risk Management</i>		
Manual 1	Emergency Risk Management—Applications Guide	A
<i>Volume 2—Risk Evaluation</i>		
	Titles to be advised (covering PPRR)	P
<i>Volume 3—Implementation of Emergency Management Plans</i>		
	Titles to be advised	P
PART III —EMERGENCY MANAGEMENT PRACTICE		
<i>Volume 1—Service Provision</i>		
Manual 1	Emergency Catering	A
Manual 2	Disaster Medicine	A
Manual 3	Disaster Recovery	A/R
<i>Volume 2—Specific Issues</i>		
Manual 1	Evacuation Planning	A
Manual 2	Safe and Healthy Mass Gatherings	A
Manual 3	Health Aspects of Chemical, Biological and Radiological Hazards	A
Manual	Civil Defence	D
Manual	Community Emergency Planning (3rd edn)	A/R
Manual	Urban Search and Rescue (Management)	D
Manual	Lifelines	D
Manual	Disaster Assessment and Survey	D
<i>Volume 3—Guidelines</i>		
Guide 1	Multi-Agency Incident Management	A
Guide 2	Community and Personal Support Services	A
Guide 3	Managing the Floodplain	A
Guide 4	Flood Preparedness	A
Guide 5	Flood Warning	A
Guide 6	Flood Response	A
Guide 7	Gathering Community Information	D
Guide	Psychological Services	D
Guide	Community Development	D
Guide	Managing Landslips	D
Guide	Managing Dambreaks	D
Guide	Disaster Victim Identification	U/R

PART IV —SKILLS FOR EMERGENCY SERVICES PERSONNEL

Manual 1	Storm Damage Operations (2nd edn)	A
Manual 2	Operations Centre Management	A
Manual 3	Leadership	A
Manual 4	Land Search Operations (2nd edn—Amdt 1)	A
Manual 5	Road Accident Rescue (2nd edn)	A
Manual 6	General Rescue (4th edn—formerly Disaster Rescue)	A
Manual 7	Map Reading and Navigation (Amdt 1)	A
Manual 8	Four-Wheel-Drive Vehicle Operation (Amdt 1)	A
Manual 9	Communications (2nd edn)	A
Manual 10	Flood Rescue Boat Operation (2nd edn)	A
Manual 11	Vertical Rescue (2nd edn)	A/R
Manual	Structural Collapse Search and Rescue	D

PART V —THE MANAGEMENT OF TRAINING

Manual 1	Small Group Training Management (2nd edn)	A
Manual 2	Exercise Management	D

Key to status: A = Available; A/R = original version Available/under Review; D = under Development; P= Planned; R = under Review/Revision; U/R = Unavailable/under Review

FOREWORD

This Manual has been developed by the Australian Medical Disaster Coordination Group (AMDCG) in conjunction with the Australian Defence Force and with extensive reference to experts. It is published by Emergency Management Australia (EMA) for use as a reference document by medical agencies. It is also the reference manual for the AMDCG training course; *Health Aspects of a Response to Chemical, Biological and Radiological (CBR) Incidents*.

Recent overseas events have seen a renewed interest in the potential use of chemical, biological and radiological materials including their deliberate use on the civil population. This was evidenced by the sarin gas attack on the Tokyo subway in 1995.

This Manual is produced in the full recognition that, while the possibility of a deliberate CBR incident against Australian citizens is low, the consequence of such an incident would be great. Therefore, it is important that health and emergency personnel are aware of their characteristics and associated treatment of persons affected by such hazards.

One aim of the Manual is to provide guidance to health and medical authorities on the protocols involved in the treatment of persons affected by chemical, biological and radiological hazards. It contains the best information available at the time of printing. Readers should refer to relevant literature for developments in this field, particularly the application of treatment protocols to a civilian population. Further guidance should also be sought through respective State/Territory health departments.

Proposed changes to the document should be forwarded to the Director General, Emergency Management Australia, at the address shown below, through the relevant State/Territory emergency management organisation.

This publication is provided free of charge to approved Australian organisations which may obtain copies from the Counter Disaster Officer/Unit located in each State/Territory health department, or from the Secretary AMDCG, Commonwealth Department of Health and Aged Care. Limited free copies for relevant (non-health) emergency management agencies are issued through each State/Territory emergency management organisation.

Manuals may be supplied to other Australian or overseas requesters upon payment of cost recovery charges. Consideration is given to requests from developing countries for copies without charges.

Overseas enquiries (for free copies) and all those regarding purchase of the Manual should be sent to the Director General, Emergency Management Australia, PO Box 1020, DICKSON ACT 2602, AUSTRALIA, (facsimile +61 (0)2 6257 7665, e-mail: EMA@ema.gov.au).

CONTENTS

The Australian Emergency Manual Series

Foreword

CHAPTER 1

Background 1

CHAPTER 2

Coordination & Control 11

CHAPTER 3

Site Issues 29

CHAPTER 4

Personal Protective Equipment & Measures 39

CHAPTER 5

Triage 63

CHAPTER 6

Decontamination 69

CHAPTER 7

Detection 105

CHAPTER 8

Dissemination 111

CHAPTER 9

Hospital Issues 117

CHAPTER 10

Forensic Issues 131

CHAPTER 11

Mental Health Issues of Hazardous Materials 137

CHAPTER 12

Public Health Aspects of CBR Incidents 143

CHAPTER 13

Health Control Issues 159

CHAPTER 14

Characteristics of Nuclear Weapons 173

CHAPTER 15

Nuclear Weapons Effects 179

CHAPTER 16

Nuclear Incident Medical Management 183

CHAPTER 17

Characteristics of Biological Agents 199

CHAPTER 18	
Biological Weapons - Effects.....	203
CHAPTER 19	
Biological Incident Medical Management	209
CHAPTER 20	
Toxins – Medical Management.....	247
CHAPTER 21	
Summary of Characteristics of Chemical Agents	265
CHAPTER 22	
Detailed Characteristics and Effects of Chemical Agents.....	271
CHAPTER 23	
Medical Management of Chemical Incidents.....	305

CHAPTER 1

BACKGROUND

THE HAZARD

1. Everyday in our normal activities, there are incidents related to chemical, biological and radiological materials. Generally these incidents are minor and are dealt with adequately at the local level. Occasionally these require a coordinated effort, a HAZMAT response, however these usually have only minor or limited effects on the general population. Very rarely this type of incident has the potential to create a major incident or disaster that requires a full DISPLAN response. This manual is aimed at ensuring that health services are prepared to deal effectively and efficiently no matter what the level of the incident.
2. On 3 December 1984, the accidental release, in Bhopal, India of the pesticide reactive intermediate product methyl isocyanate caused 2500 deaths, 150 000 permanently disabled and 200 000 people displaced.
3. In March 1995 the sarin nerve gas incident in Tokyo, Japan resulted in excess of 5000 casualties, including 11 deaths. Over 300 (>6%) of the casualties were emergency services personnel (police, fire, ambulance and medical) who responded to the incident. The low number of deaths has been attributed to a number of factors, not the least being that the sarin was of low purity and the method of dissemination was rudimentary.
4. These mass casualty incidents, highlight three important issues that CBR incidents pose for health services:
 - The potential for large numbers of casualties.
 - The long-term effects that the community and health services must address.
 - The number of casualties from the response agencies indicates that procedures for such incidents were either not developed or not followed.
5. Incidents of the nature of those above could occur in Australia, with a similar consequence. With these issues in mind, this manual has been developed to guide health service preparation for such incidents.
6. The list of agents that can cause a mass casualty incident, ranges from toxic commercial chemicals, biological materials and radiological substances (**CBR**) to specific types of these substances traditionally used in warfare. The latter are often referred to as weapons of mass destruction (**WMD**) or nuclear, biological and chemical (**NBC**) agents. The release may be accidental or deliberate, arising from the production-consumption cycles in our community, acts of terrorism or during warfare.

THREAT ASSESSMENT

7. In Australia legislation controls the manufacture, storage, transport, use and disposal of hazardous materials, thus affording the community security to a large extent, from potential problems. However, there can be no guarantee against an accidental release or malicious act using hazardous (CBR) substances.
8. Thus whilst the likelihood of these incidents may be low, their consequences are rated as medium to high (ie can cause significant personal tragedy, community hardship and environmental dislocation). Planning to deal with a potential incident is an integral part of our safety strategy. Health services, as part of this planning process should be actively involved with local, district and state/territory emergency management organisations to identify the particular hazards locally and to ensure that the appropriate response has been determined.

INCIDENT CHARACTERISTICS

9. CBR incidents may include all or some of the following characteristics. These are:
 - potential for mass casualties;
 - potential for loss of life;
 - potential for long term effects;
 - creation in some circumstances of an extremely hazardous environment;
 - relative ease and cheapness of production;
 - initial ambiguity and/or delay in determining the type of material involved;
 - potential use of a combination of CBR materials each presenting different response requirements;
 - narrow time frame in which to administer life saving interventions/treatments;
 - need for immediate medical treatment for mass casualties;
 - need for immediately available specialised pharmaceuticals;
 - need for specialised detection equipment;
 - need for timely, efficient and effective mass decontamination systems;
 - need for organised, trained and equipped health service personnel to immediately augment local Fire-HAZMAT teams;
 - need for pre-coordination within health services to establish medical treatment protocols, to stock pharmaceuticals and to determine treatment requirements;

- need to establish coordinated incident management/response procedures for such incidents;
- need to ensure early warning systems for hospitals;
- need to establish early those who are affected and those at risk;
- need for active case finding versus passive case finding;
- need to work closely with Police on site and at health care facilities, as they perform their legal duties in relation to victim identification/registration and evidence gathering; and
- need for a pro-active media policy to ensure the community is kept informed and thus its anxiety allayed.

RESPONSE CAPABILITY

10. The response capability is built around the existing DISPLAN and HAZMAT arrangements for, the local, district or State/Territory level. However, due to the highly specialised nature of these incidents and the resources required to deal with them, the response may well escalate quickly to a National health service level.
11. The National capability, is built around the arrangements established at the local level, adding centralised coordination and/ or use of Commonwealth resources as determined by the situation. The mechanism for requesting Commonwealth assistance is well documented in all State and Territory emergency operations centres.
12. The effectiveness of this hazardous incident response capability is built around the following being incorporated into all existing emergency management arrangements, ie the HAZMAT sub-plan of a DISPLAN:
 - Early identification of the hazard.
 - Personal protective equipment for responders.
 - Mass decontamination of casualties.
 - Life saving antidotes.
 - Agreed procedures and protocols.
 - Protection of the hospital infrastructure.
 - Protection of our health transport system.
 - Well-developed Public Health systems to identify and track those exposed.

COMMONWEALTH ASSISTANCE

13. The Commonwealth is able to provide a number of highly specialised support services, however, unless pre-deployed for a specific incident/event, accessing these services is via the agreed path through the State or Territory emergency management organisation. The Commonwealth response may be through deployment of Australian Defence Force resources. This may include any of the following groups or organisations listed in paragraphs 14 to 21:

Chemical Radiological Response Team (CRRT)

14. The CRRT is based in the Specialist Training Wing of the School of Military Engineering at Moorebank, NSW. The CRRT maintains a capability to deal with chemical warfare agents and radiological incidents. It maintains a limited capacity to deal with biological warfare agents and is on 12 hours notice to move. The CRRT includes explosive ordnance disposal (**EOD**) technicians. All CRRT personnel have completed nuclear, biological and chemical defence (NBCD) and chemical/biological ordnance disposal courses.
15. The CRRT is capable of leak, seal and package operations for chemical and radiological agents and isotopes. The decontamination of personnel is conducted by a team that is also capable of limited area decontamination. Using additional qualified personnel, the capability can be increased for both personnel and area decontamination. The CRRT is capable of conducting field sampling and analysis of all vapour and liquid chemical warfare agents. Further sampling is conducted by the Defence Science and Technology Organisation.

Commonwealth Advisory Panel of Experts (CAPE)

16. CAPE is an extensive range of individuals that can be called on to provide professional advice in their area of expertise.

Defence Science and Technology Organisation (DSTO)

17. DSTO provides advice on a range of issues appropriate to; detection, protection; arms control for chemical and biological agents and radiological materials and the properties of these agents and materials.

Australian Defence Force (ADF) CBR Material Support

18. ADF supplies of chemical detection, decontamination and protective equipment are held by specialised operational units and in stockpiles at defence storage centres.

Australian Radiation Protection and Nuclear Safety Agency (ARPANSA) and

19. These two organisations maintain specialised teams and resources to support emergency plans dealing with the response to radiation accidents and incidents.

Australian Animal Health Laboratory

20. This is the only laboratory in Australia with full capabilities to deal with all levels of isolation required for microbiological work. It is the principal laboratory in the Australian public health laboratory network.

Public Health Laboratory Network

21. A series of laboratories across the country, that are the reference centres for microbiological diagnostic activities

RESPONSE CONCEPT

22. The response concept used in this manual, assumes each state or territory has a sufficient capability to deal with day to day incidents, however, a major or protracted incident will require a significant degree of cooperation across borders. The local response unit is the HAZMAT Health Team* (**HHT**), remembering that the response management is as defined within the State or Territory HAZMAT (**Hazardous Materials**) plan.

Note

* (The HAZMAT Health Team is used here, in a conceptual sense, to indicate, a multi-disciplinary team made up in part or in full of ambulance, medical, nursing, public health and mental health personnel and supported by the overall Health infrastructure which includes non health expert technical and other assistance.)

23. The concept of the CBR response is built on the following elements:

- CBR Hazards awareness training.
- Detection and monitoring capability via Fire HAZMAT services.
- A mass decontamination system both on-site and at hospitals.
- Designated hospitals.
- Predetermined incident management procedures.
- Predetermined specialist advisory individuals/groups.
- Disaster victim identification (DVI)/registration (DVR) procedures.
- Commonwealth support.

Note

The type and degree of training is detailed in the accompanying training package and is designed for specialised service training, multi-agency training and a general awareness training. (See paragraph 28).

MANAGEMENT CONCEPT

- 24.** The management concepts addressed in this manual are based on the HAZMAT management principles listed below (see Figure 1):
- Secure and mark the extent of the hazard area.
 - Conduct a hazard prediction and advise the Incident Manager.
 - Isolate the source if possible.
 - Establish hot, warm and cold management zones at the site/s.
 - Commence immediate life saving assistance to casualties.
 - Establish a decontamination corridor.
 - Commence casualty extraction/triage/decontamination/treatment.
 - Establish liaison with receiving hospitals and ambulances via health control.
 - Record and assist with the evacuation of casualties to medical facilities.
 - Assist in the preservation of evidence for workplace/crime scene investigation.
- 25.** Prior to the arrival of the medical component of the HHT on-site, much of this structure will have been put in place by the responding emergency services especially fire. Knowledge of these concepts is vital to the health worker for the following two reasons:
- Site safety and function of the HHT.
 - To ensure receiving facilities have plans to recover from or control contamination when casualties arrive.

Note

Ideally, a fire service officer will normally be in command of the Hospital decontamination corridor in a major incident, however, such arrangements must be confirmed in the relevant State or Territory HAZMAT plan.

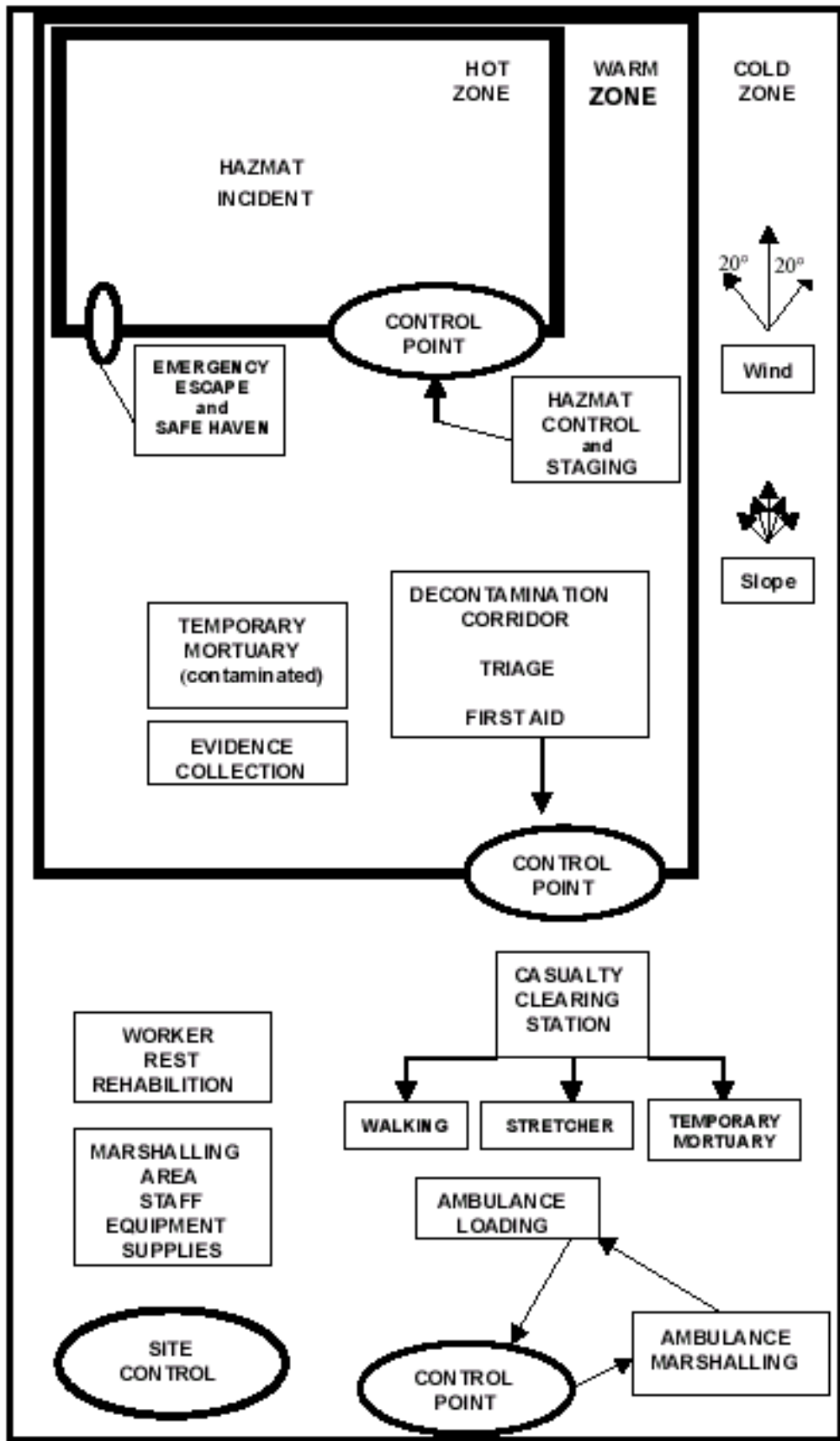

Figure 1: Stylised HAZMAT Incident Response Layout

EQUIPMENT

26. Health service personnel will require equipment appropriate to their anticipated role as defined in the HAZMAT plan. This should specify the level of equipment required and include:
- personal protective equipment (PPE);
 - detection and monitoring devices including responder monitoring;
 - decontamination equipment;
 - drugs and pharmaceuticals; and
 - site maintenance of equipment (eg batteries, consumables etc).
27. Equipment requirements are detailed in the appendices to this manual and where relevant in specific sections.

TRAINING

28. Personnel with designated roles, defined in the HAZMAT plan should receive training to allow them to safely perform their duties. A training program should include the following:
- **Awareness Training**—This should include:
 - characteristics of the hazard;
 - recognition of casualty symptoms; and
 - immediate actions and reporting procedures.
 - **Specialist Training**—More detailed training for different emergency services including, but not limited to:
 - fire;
 - ambulance;
 - police;
 - health (including hospital, public health and mental health personnel).
 - **Team Training**—This is required to ensure each service integrates its response appropriately through exercises. It therefore combines the awareness training and subsequent specialist training with the multi-agency approach required for an effective operation.
 - **Training Providers**—Careful consideration of the skills required by the trainers must be included when the training program is developed. This will ensure effective delivery.

- **Training Methods**—A variety of methods should be included in the program, ranging from didactic lectures to field exercises. However, ambitious multi-agency exercises should not be attempted until sufficient personnel have been trained and the operational plans defined.
29. Personal protective equipment training is *currently* introduced in the multi-agency awareness training package. Competency training in PPE use and maintenance will follow State/Territory HAZMAT plans.
 30. Each State and Territory must include in the appropriate service training an indication of the level of expertise required in the following and any other groups that may be involved in an incident. Generally the groups below should have, as a minimum, the awareness training element of the education package:
 - St. John Ambulance Australia;
 - State/Territory Emergency Service (S/TES);
 - bush/rural/country fire services;
 - Australian Red Cross; and
 - Volunteer Rescue Association (VRA).
 31. The **national** training guidelines have been developed by a select **national** body with wide representation and chaired by Emergency Management Australia.

CHAPTER 2

COORDINATION AND CONTROL

GENERAL

1. The control and command structure under which the principles outlined in this manual operate are defined within the State or Territory DISPLAN. Particular issues that relate to hazardous materials incidents are further elaborated within the HAZMAT sub-plan. All health service personnel should also be familiar with the particular control and command issues within their own state/territory health services plan, that will encompass responses for ambulance, medical, public health, mental health and other support agencies both public and private. Only issues particular to clarification of information within this document will be elaborated here.
2. Health CBR operations (see Figure 1) are conducted with several levels of care, each with increasing capabilities, and with the more sophisticated medical management towards the rear (in hospital). The most forward health support is usually provided by the Ambulance who will have a limited range of equipment, drugs and medical capability. Ambulance may or may not have a medical response team to assist.
3. Major advances have been made in casualty survival by developments in medical and surgical capabilities and most importantly by advances in rapid evacuation, and the early stabilisation of casualties. At the CBR incident site, early treatment and stabilisation will be particularly critical, since some of the lethal agents have very rapid onset of severe, life threatening effects. This means that far forward treatment, often by non-medical personnel, will be of even greater importance than in conventional disasters.
4. This manual is based on the concept that States and Territories will have some capability to address the health consequences of an incident medically for a period of time that is sufficient to allow assistance to be sought, transported and deployed from other States and Territories if the need arises.
5. Within each State and Territory receiving hospitals should have a capability to deal with local CBR incidents that may occur in their locality, as assessed by local risk management guidance. In metropolitan areas there may be designated facilities for day to day incidents, these being decided by among other things, the geography and predominant weather patterns in the region. All hospitals should have some HAZMAT capability, which in the absence of a specialised fixed facility, could be a documented plan addressing the potential hazards likely to be encountered and how they will be managed.

PREVENTION

6. Prevention at a macro level is almost impossible as accidents and acts of terrorism are not usually preceded by adequate warnings. However, overall

planning must address the issues of **prevention** and **mitigation** for incidents in general and the consequences of a particular type of incident. In some incidents to date there has been a pre-warning eg a threat to a food source. It is beyond the scope of this manual and for security reasons that details of these aspects of plans for prevention are not detailed here, they do exist, however, on a need to know basis.

7. At the incident level, the steps taken beforehand will be the most important in determining how many and how severe the casualties will be. Issues that should be addressed here are:
 - community-based education including in place sheltering;
 - the use of protective mask and/ or clothing as the first line of defence;
 - the use of the pre-treatments available for protection against certain CBR agents, noting the requirement with pre-treatments, for strict discipline to ensure proper use;
 - the use of training for responders to maximise protection of personnel and equipment;
 - the need for an adequately supported Incident Commander who then exercises primary responsibility for ensuring that all necessary steps are taken; and
 - the need for adequately trained health personnel/experts to advise the Incident Commander on matters of health importance. For example, health effects of the CBR agent and the physiological stress characteristics of the personal protective equipment (PPE).

Health service responders will generally follow the same training and procedures for protecting themselves as do the non-health units.

PLANNING AND PREPAREDNESS

8. The process followed in each State and Territory is to conduct a hazard analysis to evaluate the potential risk to and vulnerability of a community. When completed an emergency response plan is formulated.
9. Generally in Australia we take the **all hazards, all agency** approach, ie one plan coordinating all agencies is used to cover all hazards. The fundamental principles outlined in the DISPLAN are then incorporated into each agency response. In some special situations the plan is further refined to deal with particular issues, eg maritime, airport or HAZMAT incidents.
10. The emergency plan describes the community's pre-emergency preparedness, the issues of local responsibility and jurisdiction, scene control, medical control, resource availability, and the interrelationship between the hazardous materials emergency activities of each participant in the plan. Legislative authority is derived from the State and Territory Acts dealing with emergency responses and detailed in DISPLANS.

RESPONSE ORGANISATION

11. The general pattern of management will consist of the following components: (see Figure 2). Readers should note that these arrangements might vary between States and Territories.
- **Incident Control**—As with all incidents this is the responsibility of the Police. Control will generally be achieved via senior appointed personnel for each service, working with the police commander at the **site control point**. This aspect of control should not be confused with the overall operational coordination that takes place in local, district, state/territory or national **operations centres**. Again in the operations centres police are in overall command.
 - **Incident Management**—The **fire service** has the prime responsibility for management of hazardous materials incidents. It will establish the Incident Management Point (IMP) in a safe environment.
 - **Site Management**—Due to the complexity of many hazardous material incident sites, for planning they are best thought about in their component parts. These are shown in Table 1.

SECTOR	COMMANDER	FUNCTIONS
COMMAND	Police	LIAISON with all services. STATUS of the incident. SAFETY of the community and site. MEDIA control and coordination.
OPERATIONS	Fire	Incident Management Point Decontamination Hazard Identification
TACTICAL	Fire/Police	Rescue/Extrication Evacuation Access Control to hot/ warm zones
HEALTH	Health	Decontamination Triage Treatment Transport
STAGING	All Services	Resource Management Rest Rehabilitation

Table 1: Site Sectors and Functions

This pattern of thought should be repeated for plans relating to health care facilities.

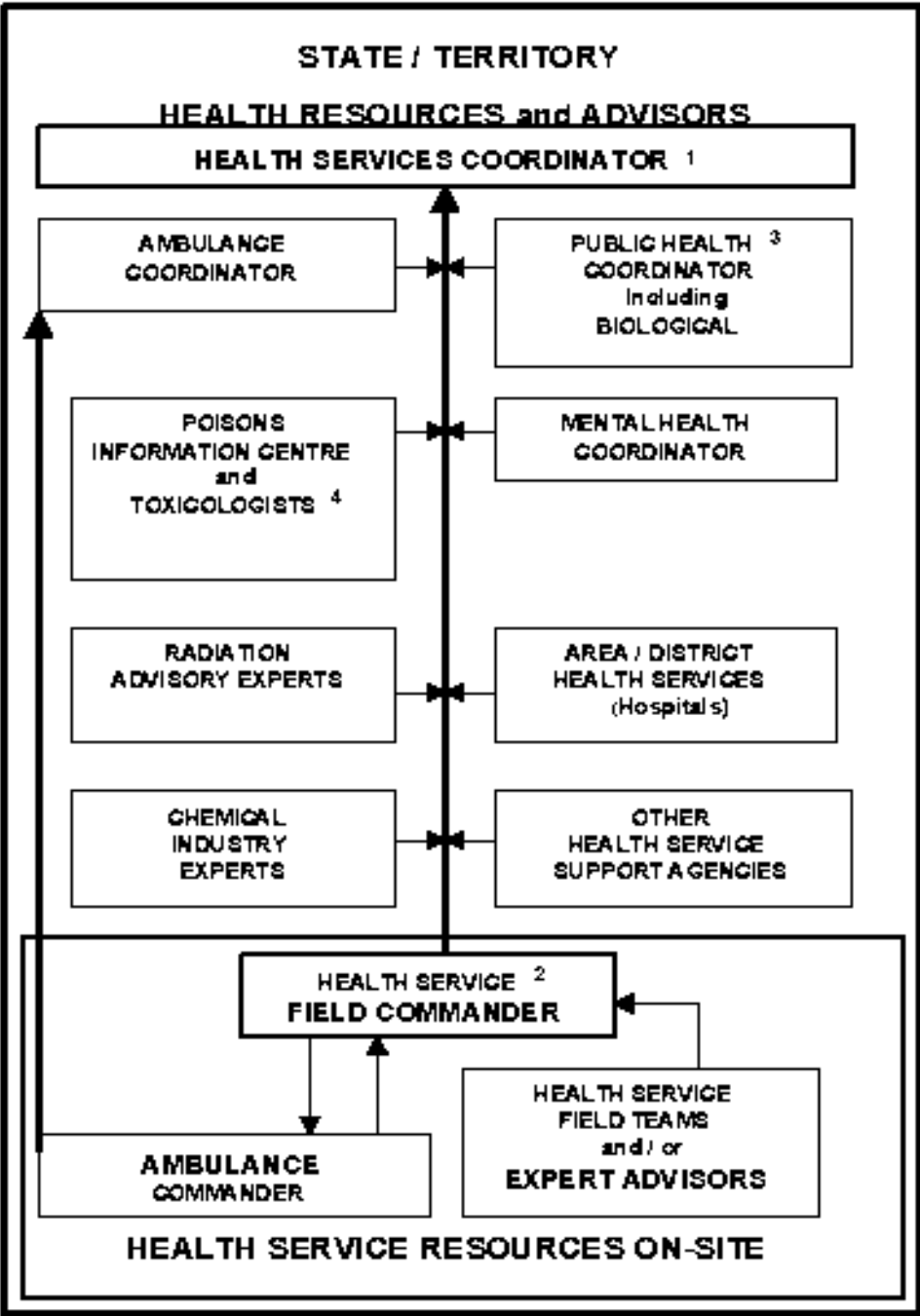

- 1 Senior officer appointed to coordinate all health resources at state, territory or local level
- 2 Officer appointed to command health resources on-site.
- 3 Responsible for liaison with SPECIALISED MICROBIOLOGY (HUMAN and/or ANIMAL) LABORATORIES
- 4 Also provides advice on SPECIALISED ANALYTICAL LABORATORY SERVICES

Figure 1: Health Service Coordination

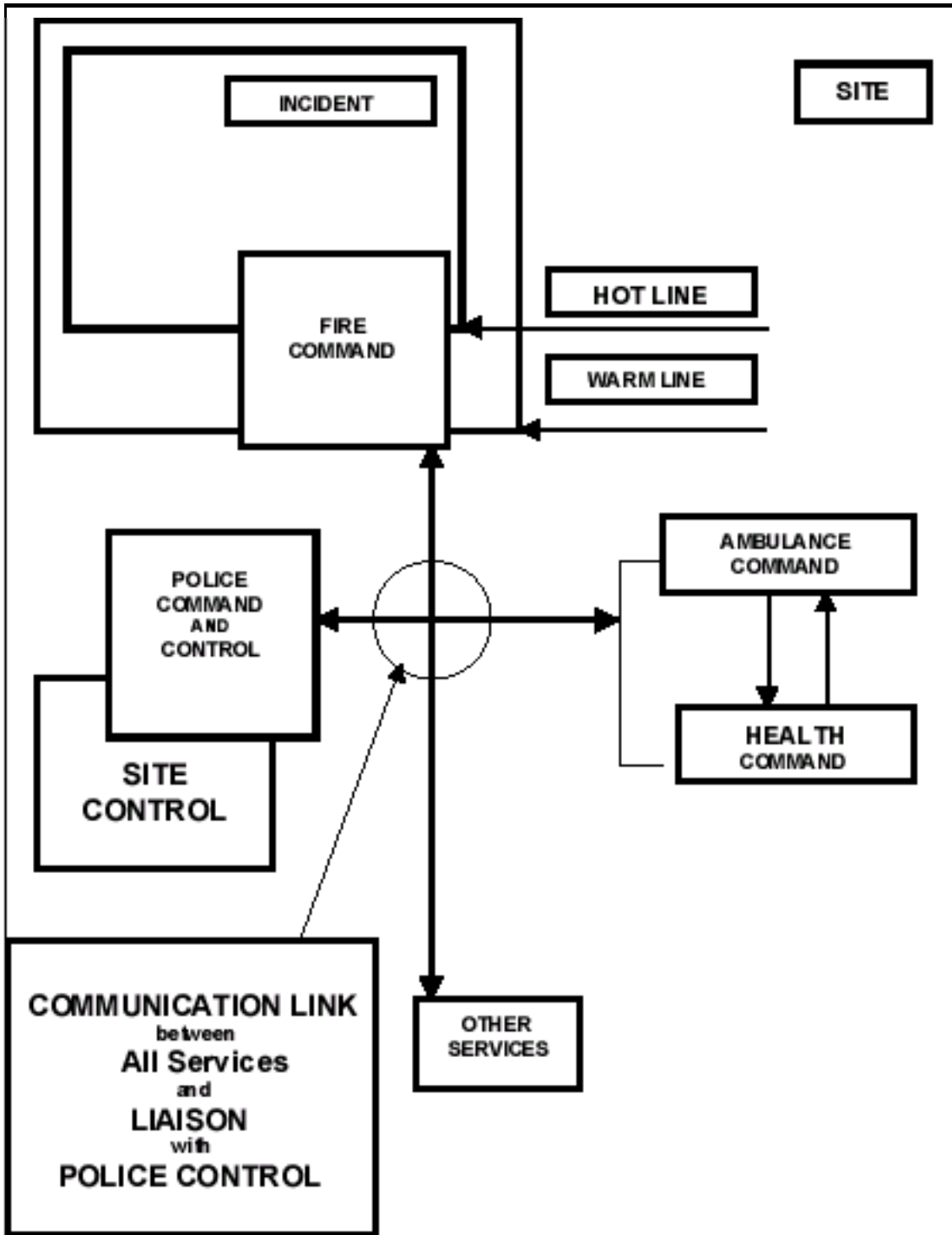

Figure 2: Control and Communication Overview

INCIDENT OBJECTIVES

12. There are four underlying objectives that direct operations in any incident; the reduction of mortality and morbidity; control of the situation; environmental issues and the conservation of property. When developing your response

consideration must be given as to how you will achieve the objectives. For example:

- Reduce mortality and morbidity by:
 - the early recognition and identification of the hazardous material;
 - isolation of the public and unprotected response personnel from the hazard, ie limiting of the number exposed (public) and the institution of absolute control over access to and from site (responders);
 - rescuing endangered persons if this can be accomplished without jeopardising rescuers; and
 - evacuating areas in which a threat to life and/or health exists. (NB. Sheltering in place is a response when time / resources are not available to evacuate or it is the safer option.)
- Incident control by:
 - identifying the mechanisms of an uncontrolled release of a hazardous material; and
 - developing a course of action to control it based on a predetermined area-wide management plan.
- Environmental concerns are:
 - the damaged portion of the environment; and
 - the methods of securing those resources necessary to restore it to as normal as possible.
- Property conservation by:
 - identifying contaminated properties; and
 - restoring them to as near a pre-incident state as possible.

13. Where the first responder to a potential CBR incident is not trained or equipped to deal with it, caution should be paramount as information is gathered to assist in evaluation of the incident. The first responder should not intervene if:

- materials are unknown and cannot be readily identified;
- atmospheric contaminants, liquid splashes or other contact will adversely affect the responder, and proper equipment is not available to prevent such from occurring;
- the incident involves explosives;
- there is a risk of fire;
- there are victims due to exposure to the material and proper protective equipment is not available to the responder;

- there will be no adverse environmental impact;
- the incident occurs in a location where it is unlikely that hazardous vapours or gases will accumulate; and
- personal protective equipment will not adequately protect personnel.

HEALTH SECTORS

14. Coordination of the health aspects of an incident is defined with-in the state or territory health services plan and elaborated in the various supporting organisation plans and throughout the levels of health management infrastructure.
15. As a general rule, health (ie excluding special ambulance groups eg SCAT—Special Casualty Access Team) response personnel will not be involved in the direct control or management of a hazardous materials release other than in an advisory capacity. This excludes health facility arrangements for **spill-teams** and specialised functions such as radiation safety officers who are trained to deal with ‘minor’ in-house accidents.
16. In the event of a multiple casualty incident, sectoring of the medical priorities is useful to ensure rapid efficient use of available resources.

Health Command

17. The commander(s) of the ‘health sector on-site’ is/(are) directly responsible to:
 - the incident commander for on-site activities including operational support by way of liaison officers and technical advice eg hazard identification and decontamination;
 - to the respective health controllers (ambulance, medical, mental health, public health and health) for patient triage, treatment and transport and responder care and treatment.
18. The primary responsibilities of the health sector are:
 - coordination and control of all health operations at the incident; and
 - evaluation of all potential medical problems with communication of this information to the incident commander and the relevant controller(s) in the health sector.

Rescue and Extrication

19. Treatment of patients should not be conducted in the exclusion area. If extrication and/or rescue of a patient from the exclusion area is necessary it should be performed by the Hazardous Materials Operations Team. Attempting impossible rescues should be avoided. Long extractions and rescues should be attempted only if there are no unnecessary risk/s to the rescuers.
20. To prevent unnecessary exposure and spread of contaminants, anyone involved in the rescue process must be considered contaminated. These personnel should not participate in patient treatment.

Triage

21. Numerous systems (see specific section on triage) are available that prioritise patients for treatment and transport to a hospital. Most use a colour and/or numerical coding to categorise patient status and treatment priority. These systems are based on four levels of priority:

Priority	Description	Comment
Priority I	Immediate	Immediate treatment and/or transport required.
Priority II	Urgent/ (Expectant) ^(a)	Urgent treatment (within 4-6 hours) and transport required, however, transport may be delayed until priority I moved.
Priority III	Delayed	Less serious cases where the time constraints for both treatment and transport do not apply.
Priority IV	Expectant*	Injuries inconsistent with survival or of such severity that resource use would compromise the treatment of large numbers of other casualties.
	Dead	

Note

- (a) *There is currently no uniformity in categorising the expectant group. Some States and Territories use the priority II category, with some indication on the triage label, whilst others use a fourth category, priority IV and a different coloured tag. Personnel that may respond across a border should be aware of the local system.*

Table 2: Triage Priority System for Patient Treatment

22. Ideally the most experienced health service responder should be the Triage Officer. By its very nature, triage requires the maximum amount of discipline and is potentially the most emotionally demanding.

Treatment

23. The treatment zone should be located in an area where patients and health personnel will be safe from toxic exposure. The initial examination of a contaminated person should determine several things. These are:
- the degree to which the injuries are related to the toxic substance;
 - which body parts have been most severely exposed;
 - the route of entry; and
 - whether the toxic material is continuing to harm the patient.

(See Chapter 5—*Triage* for the use of the acronym ASBESTOS (see chemical casualties).

Transport

24. The Medical Transport Officer (when present) is responsible for determining with the Ambulance Transport Officer priorities for patient loading and transport to hospitals, the latter (distribution decisions) in conjunction with the health controller.
25. With decontaminated patients and severely contaminated urgent transports to hospitals, conventional patient transport modalities should be used. It must be recognised, however, that the latter category and routine transport of contaminated casualties will contaminate both the vehicle and the crew. Protection of both is vital as loss of either may compromise the response.
26. The detail in relation to crew and vehicle protection and decontamination can be found in the State or Territory ambulance emergency plan, as well as identification of alternate types of vehicles suitable for casualty movement.

Staging

27. Health services will be required to provide their own logistical support and may be required to assist other agencies with the management of their personnel where adverse affects of the agent(s) and / or heat stress affect responders during the operation.
28. For details regarding the management of the dead see Chapter 10—*Forensic Issues* and Chapter 12—*Public Health Aspects of CBR Incidents*.

DECONTAMINATION

29. The external decontamination process is controlled by the fire services, however, health services may be involved:
- before the process begins to triage and to institute life saving measures;
 - during the process to deal with medical emergencies and additional decontamination; or
 - after the process for issues relating to internal decontamination.
30. Issues in the decontamination process that must be addressed in the coordination and control of an incident appear below:

- The decontamination corridor should:
 - be located uphill and upwind of the incident;
 - ensure water run-off does not contribute to the incident and
 - be easily identifiable by all personnel.
 - The decontamination process should be as follows:
 - It should provide for systematic removal of contaminants as the patient or rescuer moves from the 'dirty' to a 'clean' area.
 - It should be conducted by personnel attired in appropriate protective clothing.
 - It must provide for sufficient mild soap and water for the scrubbing and rinsing processes.
 - It should ensure that the water spray and run-off is adequately contained and kept to a minimum.
 - It must begin with removing all the patient's clothing.
 - It must provide for adequate containers to store clothing.
 - It should provide for appropriate containers for storage of personal effects (eg watches, jewellery, wallets, etc).
 - It must provide for adequate numbered tags to link individuals with their clothing and personal effects. These tags or labels must be sufficiently robust to survive the process of decontamination without becoming detached from the patient or belongings. This process is a vital part of the victim registration and tracking process required by police and health. The number should be recorded in the health record to facilitate return of items that can be returned.
 - It should, if possible, ensure a pre-decontamination test is conducted on the patient to determine what the contaminant is.
 - It should, if possible, ensure a post-decontamination test is conducted on the patient's to ensure they are decontaminated.
 - It should be supported by expert advice and reference materials to assist in determining whether any special decontamination process is necessary.
- 31.** Occasionally, on-site decontamination may not be practical (eg extreme cold etc). In these instances, plans should be in place to cover the following:
- Commencement of life saving care.
 - Preliminary decontamination (ie less than one minute). If possible remove patient's clothing before entry to the transport vehicle.
 - If contaminated clothing cannot be removed safely, wrap patient in plastic bags or blankets to decrease the risk of contaminating the transport personnel, equipment and vehicle.

MEDICAL RECEIVING FACILITIES

32. Some patients arriving at the medical receiving facility may still be contaminated. This may result in a secondary hazardous materials incident at the hospital unless adequate plans are in place. Each medical receiving facility (hospital) must have a dedicated section in its emergency incident plan that specifically deals with the reception and management of contaminated patients.
33. The plan should have, among other things, statements clearly setting out provisions for:
- recognition that health services has the primary role in control over protection of the facility as a community asset;
 - notification of appropriate medical and administrative personnel;
 - activation of a decontamination team;
 - rapid identification of areas already contaminated and instituting their management;
 - establishment of an isolated (from the main hospital) receiving area;
 - staffing of the decontamination area by properly trained and experienced personnel working with appropriate types and levels of equipment and protective clothing;
 - a method of rapidly securing facility entrances and exits to minimise contamination;
 - a memorandum of understanding with the police if necessary regarding facility security;
 - recognition of the primary role of fire services in the process of decontamination;
 - a memorandum of understanding with fire services regarding facility based decontamination;
 - protection of and/or collection of forensic evidence; and
 - an identification system for casualties and their belongings similar to that used in the field, to ensure clothing and personal items can be traced back to a particular individual.
34. Other issues to be considered are air-handling systems and waste management including water run-off, contaminated clothing and disposable equipment. This may require coordination through the local Environmental Protection Authority (EPA).
35. If the facility does not have a permanent decontamination area, other options for a hospital plan include use of the apron to the emergency department, a car park or a portable self-contained decontamination unit. Other nearby buildings/sites that are more expendable than a health care facility (eg halls, playing fields etc.) may be considered as options. This is applicable if recognised before or after medical facility admission.
36. See Chapter 6—*Decontamination* for recommendations and plans for both mass casualty and potentially highly contaminated single patients.

HEALTH CONTROL

General

37. The health control (Figure 1) of a hazardous materials incident is extremely important, since it can have such widespread health implications for pre-hospital and hospital personnel as well as the community as a whole.
38. Exposure to toxic materials is probably the most significant type of incident where immediate implementation of medical control will be required to ensure the proper management of patients. Although biological and radiological incidents have a relatively longer symptom onset time they also warrant early access to medical expertise and control.
39. On-line health control (as specified in the agreed State and/or Territory plan) during a hazardous materials incident should be established early by the responders. In these incidents the Health Controller should have direct access to a trained and experienced physician with a background that should include emergency medicine and involvement with pre-hospital emergency medical systems. Ideally, this would be a hospital-based physician who is familiar with the logistics and capabilities of pre-hospital health personnel. It will frequently be advantageous for this physician to have direct access to a toxicologist and/or the Poisons Information Centre and/or the Public Health Unit.
40. In some instances, personnel at the scene may request an on-site medical commander to assist with diagnosis. In large incidents this provides continuous and ongoing medical control without requiring time-consuming radio contact. If an on-site physician is requested, only one who is trained and experienced in the provision of medical care in the field should respond.

Health Controller Information Requirements (Also see Chapter 13)

41. The following is a list of the issues that will need to be considered in the Health Controller's decision-making processes. Rapidly assess the CBR incident by:
 - determining the type(s), size, and distribution of the release, noting the:
 - means of release(s) (eg atmospheric dispersion, explosion, fire or spill);
 - size of the release (estimated weight/volume of chemicals dispersed); and
 - distribution (dispersion area) of the release.
 - Identify the specific type(s) of CBR agents and their reaction by-products by:
 - name, quantity and concentrations of the chemicals;
 - emphasis on specific chemicals involved and their chemical reaction, if any; and
 - emphasis on reactivity and physico-chemical properties.
 - Identify human exposure pathways noting that:

- public health impacts are directly determined by the routes and amounts of exposure for humans;
- during the impact phase (release on-going), inhalation may be the route; and
- during the post-impact phase dermal exposure through direct contact objects or ingestion of contaminated food or water routes of exposure.
- Define the population(s) at risk by considering:
 - number and types of occupational and emergency response workers;
 - types of protection during exposures;
 - proximity and size of residential neighbourhoods;
 - location and numbers of high-risk people (eg elderly, infirm, children);
 - structure of residential, commercial and public dwellings; and
 - preparedness response of residents.
- Conduct toxicological/radiological/biological evaluation and assessment, remembering:
 - CBR expertise required, depending upon the specific agent involved, may be beyond the capability of State/Territory expertise;
 - to use chemists/physicists, public health epidemiologists, radiation experts and poison information specialists and poison information centres; and
 - to use toxicology databases (Poisons Information Centre).
- Describe morbidity and mortality, remembering:
 - characteristics may provide or define the need for epidemiological surveillance to determine the incidence, distribution, location, type and severity of health related effects;
 - to identify as early as possible a case definition;
 - epidemiological descriptive information is invaluable for assisting with the allocation of medical resources;
 - to estimate the need for additional health services;
 - to augment efforts to develop rosters of exposed persons; and
 - to conduct censuses of exposed populations.
- Identify appropriate treatment regimen(s):
 - based on relevant toxicological and epidemiological information, consensus of clinical opinions used to identify the most appropriate treatment regimen(s) for symptomatic persons; and

- ensuring information should be quickly disseminated to appropriate emergency care and medical care providers.
- Evaluate emergency medical care and health service capabilities remembering:
 - to expect exacerbation due to societal disruption, public fear, new operating procedures, amounts of work to be completed, levels of coordination and organisation required, etc;
 - the amount of exacerbation is largely determined by and is inversely proportional to the amount of preparedness planning;
 - to evaluate the availability and quantity of appropriate medical care;
 - evaluation should include a determination of the status of emergency medical care capability, both personnel and facilities, along with identification of backup capabilities;
 - once acceptable diagnostic criteria and treatment regimens are established, the medical care assessment should include evaluation of capability and needs to diagnose and treat exposed persons; and
 - evaluation should also include consideration of capability for decontamination of patients in order to prevent secondary exposures among medical care providers.
- Ensure provision of appropriate medical care remembering:
 - medical treatment protocols should be established and address relevant diagnostic tests;
 - treatment regimens for emergency settings;
 - antidotes;
 - medications;
 - equipment;
 - medical specialist expertise;
 - this information needs to be disseminated to all appropriate practising physicians; and
 - to establish procedures to ensure that clinically affected persons enter the medical care system.
- Identify and evaluate environmental control strategies remembering:
 - they are identified and implemented with the objective to control the spread of contaminants in the environment; and
 - it is important to minimise additional occupational and non-occupational exposures.
- Evaluate evacuation and mass care strategies remembering:
 - that as part of the rapid assessment, determine whether the population(s) can stay in the affected areas or should be evacuated;

- to include high-risk populations;
 - to review specific evacuation issues (appropriateness, impediments of effectiveness, feasibility, compliance, health criteria for re-occupation, handling separated family members and pets, etc. (**Note:** Communication with the Department of Agriculture and/or veterinary surgeons will facilitate information flow to victims));
 - to review guidelines for the notifying, moving and providing mass care for the population;
 - that persons evacuated and placed in mass care shelters need relevant health and safety plans; and
 - to discuss with other relevant responding organisations as part of evaluation.
- Develop criteria for defining comprehensive databases including:
 - actual or potential public health impacts which may require accurate and comprehensive databases of exposed populations for future socio-economic assistance;
 - registry development;
 - long-term clinical follow-up; and
 - epidemiological investigations.

HEALTH SUPPORT EXPERTS

Epidemiologists

42. The epidemiologist's role involves:

- liaison with the police;
- primary prevention (processes exist for the passing on of information gathered by intelligence networks however, this is beyond the scope of these guidelines); and
- provision of health-related technical guidance for preparedness and response, including defining the population at risk.

43. Activities that may benefit from epidemiologist input include:

- solicitation of legislative support;
- augmentation of operational aspects of contingency planning;
- health and safety training for responders; and
- education of defined populations at risk.

44. With decentralised plans (emphasis at the local level) efforts by the epidemiologist should have similar priority. They should provide input into risk analyses for preparedness planning in terms of assisting with derivation of valid and descriptive estimates of associated mortality and morbidity during an emergency response.

45. Accurate assessment and prediction of these public health impact estimates are necessary for maximising efficacy of allocation of finite medical resources by the health service.

The Poisons Information Centre

46. The trained pharmacists provide a full-time service that is supported with skilled medical and clinical toxicological/toxinological expertise. The poisons information centre can assist in a toxicological emergency response via:
- full-time pharmacists expert in the retrieval, analysis and communication of medical toxicological and chemical information;
 - accessibility 24 hours a day, 7 days a week for public and medical personnel access;
 - ability to rapidly disseminate technical and clinical information dealing with hazardous materials;
 - ready access to consultants from various medical, laboratory, industrial, and occupational health-related clinical and scientific specialties;
 - systems for record keeping and review;
 - ability to provide information including physical property data, chemical property data, reactivity and toxicity information, and medical management advice;
 - linking through the health controller to the public health unit, safety agencies, on-scene incident responders and area or health services;
 - ability to assist in determining type of substance involved and its potential threat both short and long term;
 - provision of accurate and clear information for public release via the public health unit;
 - evaluation of toxicological information and data on hazardous materials and become an accessible repository of this information and data; and
 - involvement in a surveillance role to help identify and remove undetected environmental toxic hazards from the community.

Radiation Safety Officer (RSO)

47. Defined in State/Territory plans.

Environmental Health Officer (EHO)

48. Defined in State/Territory plans.

Infectious Diseases/Tropical Medicine Specialists

49. Defined in public health plans.

SPECIAL CONSIDERATIONS

Special Problems in Hazardous Materials Incidents

50. Each health care facility should be aware via its own local emergency management network of the substances manufactured and stored in its locality and be prepared to treat casualties from those sites.

Emergency Pharmacotherapy in Hazardous Materials Exposures

51. The store of antidotes and other pharmacological preparations will depend on what industries are in the local area and what additional substances must be kept for unusual situations. The latter will usually be decided at a State or Territory level and be supported by appropriate education and training.

COMMUNICATIONS

52. The communications systems are similar to those used in other incidents. All messages should be sent to the next level above or to the person that has tasked you. At the command and control levels there is cross communication with officers of the other services.
53. Generally for Health in the field, communications are supplied and maintained by Ambulance.
54. Specific issues that must be addressed locally are:
 - the inability of fully suited and/or masked personnel to communicate normally, ie verbally; and
 - the need to ensure health care facilities have appropriate arrangements for communications at secondary sites, if they develop.

CHAPTER 3

SITE ISSUES

(Site in this context refers to the actual incident location and/or the health care facility)

AIMS OF HEALTH SERVICES

1. The aims of Health Services are to provide:
 - a continuum of care; and
 - centralised control with flexibility of execution.

LEVELS OF CARE

2. In the planning process attention must be paid to the levels of care during an incident and thus potential areas to influence management issues. These are generally recognised as:
 - self-aid/buddy aid or treatment provided by health personnel or others trained to use specific drugs;
 - decontamination;
 - site triage;
 - casualty clearing station;
 - responder care;
 - transport;
 - hospital care; and
 - long-term care/monitoring.

HEALTH SERVICES SUPPORT IN HAZMAT ENVIRONMENT

3. The HAZMAT health team members deployed to an incident should be able to provide assistance in three areas:
 - **Pre-incident**—Areas of assistance should include:
 - knowledge of the characteristics of anticipated agents and the effects of these agents on individuals and on team operations;
 - defensive planning (including use of individual protective equipment);
 - a full understanding of self-aid, buddy aid, and medical pre-treatment;

- casualty decontamination;
 - activation of collective protection and detection/ monitoring equipment; and
 - an ability to implement protective measures including use of shelters and dispersal.
- ***During the Incident***—Areas of assistance should include:
 - detection and monitoring for the continued presence of the agent;
 - guidance to commanders on potential performance degradation;
 - first aid measures;
 - initial treatment and evacuation of casualties; and
 - individual protection and collective protection, including chemically resistant shelters.
 - ***Post-Incident***—Areas of assistance should include:
 - monitoring and reporting of chemical contamination and effects;
 - control of contamination (avoidance, limitation of spread, weathering/decay);
 - damage assessment and control;
 - monitoring for effects on command, control and communications elements;
 - medical treatment, evacuation and/or quarantine of chemical casualties;
 - use of casualty bags or wraps; and
 - assist with the operation and supervision of casualty decontamination corridors with the responsible agency (usually the fire service).

KEY OBJECTIVES IN SITE MANAGEMENT

4. The key management objectives are:
- minimising CBR agent injuries;
 - preventing aggravation of traumatic injuries during the first aid and decontamination procedures;
 - controlling the spread of CBR contamination; and
 - continuation of the primary medical objectives.

SITE SAFETY

General

5. Agency responsibilities and procedures are as follows:
 - The fire service will be in-charge of the incident site so knowledge of their procedures is essential.
 - Police, fire and ambulance services are legally designated first responders and will be the initial agencies on site.
 - An incident management system is implemented at all hazardous materials incidents.
 - Operations are controlled by a designated incident commander (fire) and follow established written standard operating procedures.
6. Various agencies involved in an emergency response to a hazardous materials incident may use different types of the incident management system. The important point is that there is a system and that everyone who may respond to a hazardous materials incident is familiar with the way the **combined** system functions.

Personnel Accountability

7. A standard personnel identification system to maintain accountability for each member engaged in activities at an incident scene. This personnel identification system should have the ability to provide a rapid accounting of all members on the incident scene.
8. The location of staff should be known at all times, especially those in the hot zone. Fire services have systems such as tally boards. Seek their advice locally. There is also a requirement for:
 - standard operating procedures to evacuate personnel from an area; and
 - a standard warning system.

Rest and Rehabilitation

9. The Incident Commander, service commanders/ safety officer(s) should consider the circumstances of each incident and make suitable provisions for rest and rehabilitation for members operating at the scene. The provisions should include:
 - medical evaluation and treatment;
 - food and fluid; and
 - relief from extreme climatic conditions.

10. Rest and rehabilitation should be taken in groupings that will allow some debriefing. Additionally, consideration should be given to the establishment of a common facility for personnel in each zone or separate facilities for each responding service. Finally, general safety procedures that are to be followed at an incident should be prepared, and distributed.

Ignition Sources

11. Ignition sources should be eliminated whenever possible at incidents involving releases, or probable releases, of ignitable materials. Whenever possible, electrical devices (medical) used within the hot zone should be certified as intrinsically safe by recognised organisations.

CONTROL ZONES

12. Control zones are established at an incident as soon as possible to reduce contamination by controlling and directing the operations and movements of personnel at the incident.

Site Map

13. A site map that shows wind direction and topography will prove absolutely necessary for any incident where the hazardous materials can move via wind or flow across the ground.

HOT ZONE

14. The 'hot' zone is the area immediately surrounding a hazardous materials incident, extending far enough to prevent adverse effects from hazardous materials releases to personnel outside the zone. This zone may be referred to as the 'exclusion zone' or 'restricted zone' in other documents.
15. Access is limited to those persons necessary to control the incident. A log is to be maintained at the access control point to record entry and exit time of all personnel in the hot zone. Personnel within the hot zone should wear the level of protective equipment the incident commander has determined to be appropriate.

WARM ZONE

16. The 'warm zone' is the area surrounding the hot zone where personnel and equipment decontamination and support to the hot zone take place. It includes control points for the access corridor and thus aids in reducing the spread of contamination. This zone is also referred to as the 'decontamination', 'contamination reduction', or 'limited access' zone in other documents.
17. Personnel entering the warm zone from the cold zone should wear the level of protection required to operate in the warm zone.

COLD ZONE

18. The 'cold' zone contains the command post and such other support functions as are deemed necessary to control the incident. This zone may also be referred to as the clean zone. The perimeter will be controlled by the police service.
19. Personnel in the cold zone may wear normal work clothes. The cold zone should be upwind of the hot zone and as far away from it as is practical.
20. Support functions in the cold zone might include command post, site security, medical support, reserve equipment, and a field laboratory. As the responders are relying on makeshift facilities, standard operating procedures should be developed to guide the selection and/or acquisition of these facilities.

COMMUNICATIONS

21. Effectively handling any emergency depends on establishing coordinated communications system. Hazardous materials incidents, however, are often more complicated than 'routine' emergencies as the personal protective equipment employed may make useless traditional systems of communication.
22. When personal protective clothing or remote operations inhibit normal communications, a more effective means of communication, such as radios, should be established. The frequencies employed in such radios should be 'dedicated' and not used or shared with other local agencies.
23. Where multi-channel radios are available to personnel, the incident commander can designate a particular channel for all on-scene communications. This radio channel should be a non-repeated channel (simplex) used only for emergency on-scene communications. Another channel (not a dispatch channel) should be reserved for the incident commander to communicate with the incident control centre.
24. Communication should be supplemented by a prearranged set of hand signals and hand-light signals to be used when primary communication methods fail. (See *also* the earlier section on communications in paragraphs 52 and 54 of Chapter 2.)

MONITORING EQUIPMENT

25. Agent monitoring equipment, such as the chemical agent monitor (CAM), should be available from the fire service, (this may need to be part of the memorandum of understanding), to determine:
 - if agent vapours have been absorbed on surfaces of the casualty's clothing or equipment before entering a treatment area; and
 - if decontamination procedures have been properly accomplished.

26. Monitoring equipment operates on several different principles and measures different aspects of hazardous materials releases. **All items of sensing equipment have threshold limits with which operators must be familiar.**
27. No single device can provide all the data required to establish the presence, identity and concentration of a particular agent. The Fire service has the expertise in this area and well-developed communication systems to back-up expert advice and support. Examples of such equipment include the following:
- Oxygen metres. (Atmospheres that contain less than 19.5 percent oxygen are generally considered to be deficient and can cause reduced mental capability and dizziness).
 - Combustible gas indicator (explosimeter).
 - Carbon monoxide metre.
 - pH metre.
 - Radiation detection instruments.
 - Colorimetric detector tubes.
 - Organic vapour analyser.
 - Photo-ionisation metre.
 - Air sampling devices.
 - Other meters to measure specific products such as chlorine, hydrogen sulphide or ethylene oxide.
 - pH paper or strips.
 - Organic vapour badge or film strip.
 - Mercury badge.
 - Formaldehyde badge or strip.
28. All monitoring equipment should be operationally checked prior to use and periodically calibrated in accordance with manufacturers' specifications. **Access to specialised equipment should be anticipated at hospitals and predetermined with the fire service.**

MEDICAL ISSUES RELATED TO CBR CLOTHING USAGE

29. Only personnel who have been trained in the correct and appropriate use of protective clothing and equipment should don such gear. Work output in fully enclosed protective suit is decreased by approximately 50 per cent.
30. The consequences of wearing protective clothing relates to the inability to deal with the heat load generated by the body in an encapsulating suit. Following are the effects compared to wearing normal clothing:

- Body temperature rises 1.5 times as fast.
 - Heart rate increases 80 per cent.
 - Endurance times are reduced by 60 per cent.
 - Weight loss is 40 per cent higher.
 - Perspiration evaporation is halved.
31. The above effects apply in normal temperate conditions and commanders should be aware of the potential for personnel to be affected. Part of the agency safety officer's role must include monitoring of personnel in protective suits, including the need for increased energy and fluid intake.

First Aid for a Chemical Casualty

32. The following points apply:
- **ABC**—Airway, breathing and circulation as with other incidents.
 - **Antidotes**—The use of specific antidotes etc (if trained and authorised to do so).
 - **Self-Aid**—Self-aid for decontamination and the self-administration of an antidote if the individual is affected by the agent. Administration of antidotes in the absence of symptoms should not be performed unless directed otherwise. If available, a mask should be applied immediately to prevent further exposure.

DECONTAMINATION

33. Generally, three lines are required for casualties. There are:
- walking (including separation of males and females for reasons of modesty);
 - stretcher and personal belongings; and
 - a separate set-up for personnel in protective dress providing for walking, stretcher and equipment decontamination.

Equipment decontamination for responders may need to provide for vehicles also. Each line must have clearly marked entry and exit points.

Site Entry Point

34. Requirements for entry points are:
- clearly demarcated area into which all casualties arrive;
 - ambulances/stretcher bearers unload casualties at this point;
 - ambulatory casualties report to this point;

- the entry and exit paths must also be clearly marked;
- staffing in this area may be minimal, and all casualties arriving at this area should be sent to the triage station; and
- **All patients will be tagged at this point to ensure that patient, clothing and personal effects can be traced. This aspect must be coordinated with the fire service and police (DVR) in each State and Territory.**

THE TRIAGE POINT

35. The triage officer should:

- allocate one of the four triage categories;
- know the natural history of the injuries, including CBR effects;
- know evacuation capabilities;
- know the facilities available at higher levels of care;
- know site decontamination capabilities; and
- know available resources for medical care.

36. The triage officer will send casualties to the:

- waiting area;
- casualty clearing station;
- decontamination area; or
- dirty evacuation area.

Triage should be repeated several times at the site according to the decisions involved in allocating resources for the care of patients.

Triage Categories for Casualties of CBR Agents

37. *Also see Chapter 5—Triage.*

38. The current recommended method is the MIMMS sieve and sort. Generally this will not commence until casualties have been rescued from the hot zone in a HAZMAT incident. The ability to use the MIMMS system in the hot zone will be dependent on the health expertise available at the forward point eg ambulance officers. NB: The first decision may well be; to move or not to move the victims.

THE DECONTAMINATION CORRIDOR

39. See Chapter 6—*Decontamination* for detailed information.

The Exit Point

40. This must be well marked and protected to ensure no accidental decontamination of the clean zone occurs. Casualties may well require triage at this point depending on the distance to the casualty clearing station.

THE CASUALTY CLEARING STATION (CCS)

41. This should be set-up according to local guidelines in the cold zone. With limited resources available, the major tasks of the CCS are to provide lifesaving care and to prepare the casualty for evacuation.

CHAPTER 4

PERSONAL PROTECTIVE EQUIPMENT AND MEASURES

GENERAL

1. Personal protective equipment (PPE) is a vital component of the approach to the management of HAZMAT incidents. The level of protection required will be determined by the hazardous material present and the degree of contamination remaining on the casualties.
2. It is imperative, however, to understand that the personal protective equipment is not sufficient on its own. To function safely each individual requires an intensive training program covering the selection, use, maintenance, storage and inspection of the equipment. A regular maintenance program must supplement this. Coupled with this is an understanding of the physiological effects of PPE on the individual.
3. Personnel must also be trained and operate according to the agreed procedures and plans governing such operations.
4. Generally the selection of equipment will be made at a State or Territory level with Commonwealth input. The training will then be tailored to the equipment type to be used. The accompanying training manual covers these important aspects.
5. The following is background information on equipment principles, levels of protection and the problems encountered with wearing the suits.

EQUIPMENT STANDARDS

6. Generally, PPE required in the workplace is defined under occupational health and safety (OHS) standards and/or by Standards Australia. Where these are not available, reference is made to Australian Defence Force recommendations and/ or overseas standards. When choosing PPE, the following points will need to be taken into account:
 - It must meet OHS standards.
 - It must be provided, maintained, and used.
 - It must provide protection against physical, chemical, and thermal hazards.
 - It will need to address the hazards associated with their use namely; false sense of security; fatigue; heat stress; limited vision and impaired communications.
 - It should avoid under-protection/over-protection.

Note

Health personnel will not need to be equipped with all three types.

RESPIRATORY PROTECTIVE EQUIPMENT

7. Assume that an inhalation hazard is present or potentially present. Positive-pressure, self-contained breathing apparatus (SCBA) is the minimum type of respiratory protection that responders must wear in unknown or known toxic environments.
8. Monitoring may indicate that a decreased level of protection is appropriate.

SELF-CONTAINED BREATHING APPARATUS

9. Features of this equipment include:
 - open circuit SCBA (self-contained breathing apparatus) provides air to the mask from a cylinder, and the wearer exhales directly to the atmosphere;
 - closed circuit SCBA allows re-breathing of exhaled gases that have had carbon dioxide removed by a filter/scrub system and supplemented with oxygen from a supply source; and
 - personal alert safety system (PASS) is a device that sounds an alarm if the wearer does not move after 30 (± 5) seconds.

AIR-PURIFYING RESPIRATORS

10. This equipment includes the following features:
 - They filter particulate matter (HEPA) and other contaminants from the air.
 - They are worn only in atmospheres where the type and quantity of the contaminants are known and sufficient oxygen is known to be present.
 - They rely on filters designed to purify the ambient air in which they are used.
 - They cannot be used in atmospheres that contain less than 19.5 per cent oxygen or in atmospheres that contain contaminants immediately dangerous to life or health.
 - When they are used, the oxygen level and the contaminated atmosphere must be monitored.
 - Depending on filter size a mechanical assist device may be required to overcome the work of respiration.

PROTECTIVE CLOTHING

Suit Construction

11. Chemical-protective clothing (CPC) is made from special materials and is designed to prevent the contact of chemicals with the body. Chemical-protective clothing is of two types: totally encapsulating and non-encapsulating.
12. Totally encapsulating suits are generally one-piece suits designed to protect the wearer against gases, vapours and splashes.
13. Non-encapsulating suits usually come in component parts and will protect against gases and vapours, if worn properly. However, if worn incorrectly protection is not guaranteed. These suits contain a charcoal layer that absorbs the gases and vapours preventing penetration of the garment.

Performance Requirements

14. Measures of performance requirements include chemical resistance, permeation, penetration, flexibility, abrasion, temperature resistance, shelf life, and sizing criteria. The definitions below should assist in understanding suit performance.
 - **Chemical Resistance**—The ability to prevent or reduce degradation and permeation.
 - **Degradation**—The molecular breakdown of the material which then allows penetration.
 - **Permeation**—This is defined by two terms, permeation rate and break-through time.
 - **Permeation Rate**—The quantity of chemical that will move through an area of protective garment in a given period of time, usually expressed as micrograms of chemical per square centimetre per minute.
 - **Break-Through Time**—The time required for the chemical to be measured on the inside surface of the fabric.
 - **Ideal Protective Fabric**—One that has the longest break-through time and a very low permeation rate.
 - **Penetration**—The movement of material through a suit's closures, such as zippers, buttonholes, seams, flaps, or other design features. Torn or ripped suits will also allow penetration.

Thermal Protection

15. There are four types of thermal protection as detailed below:
 - **Proximity Suits**—The following should be noted:

- They provide short-duration and close-proximity protection at radiant heat temperatures as high as 1093°C (2000°F) and can withstand some exposure to water and steam.
- Respiratory protection needs to be provided with them.
- They are not designed for fire entry.
- They are often worn over other protective clothing.
- **Fire Entry Suits**—The following points should be noted:
 - They provide protection for brief entry into a total flame environment at temperatures as high as 1093°C.
 - They are not effective or meant to be used for rescue operations.
 - Respiratory protection needs to be provided with these suits.
- **Over-Protection Garments**—These garments are worn in conjunction with chemical-protective encapsulating suits.
- **Low-Temperature Suits**—The following points should be noted:
 - They provide some degree of protection of the encapsulating chemical-protective clothing from contact with low-temperature gases and liquids.
 - They are worn outside the encapsulating chemical-protective clothing and are used only when the risks require them.

LEVELS OF PROTECTION

16. Personal protective equipment has been divided into four categories based on the degree of protection afforded. These guidelines have been established by the United States National Institute of Occupational Safety and Health (NIOSH), Occupational Health and Safety Agency (OSHA) and the Environment Protection Agency (EPA). These categories are used here as a guide. The reader should consult local standards as they apply.

Level A

17. This level of protection is used when the greatest level of skin, respiratory, and eye protection is required. The characteristics are as follows:
- Pressure-demand, full face-piece, self-contained breathing apparatus (SCBA), or pressure-demand air line respirator with escape SCBA.
 - Vapour-protective suits: totally encapsulating chemical protective suits (TECP suits) constructed of protective clothing materials that:
 - cover the wearer’s torso, head, arms, and legs;

- include boots and gloves that may either be an integral part of the suit or separate and tightly attached; and
- completely enclose the wearer by itself or in combination with the wearer's respiratory equipment, gloves, and boots.
- All components of a TECP suit, such as relief valves, seams, and closure assemblies, should provide equivalent chemical resistance protection.
- Coveralls (optional).
- Long underwear (optional).
- Gloves, outer, chemical-resistant.
- Gloves, inner, chemical-resistant.
- Boots, chemical-resistant, steel toe and shank.
- Hard hat worn under suit (optional).
- Disposable protective suit, gloves, and boots (depending on suit construction, can be worn over totally encapsulating suit).
- Two-way radios (worn inside encapsulating suit).

Level B

- 18.** This level of protection is used when the highest level of respiratory protection is necessary but a lesser level of skin protection is needed. Similar to level A except that the suit is not a one-piece fully encapsulating unit.

Level C

- 19.** This level of protection is used when the concentration(s) and type(s) of airborne substance(s) are known and the criteria for using air-purifying respirators are met. Equipment and clothing are as follows:
- Full-face or half-mask, air purifying respirators, self-contained positive pressure breathing apparatus.
 - Hooded chemical-resistant clothing (overalls, two-piece chemical-splash suit, disposable chemical-resistant overalls or charcoal suits).
 - Coveralls (optional)—to prevent wetting.
 - Gloves, outer, chemical-resistant. Gloves, inner, chemical-resistant.
 - Boots, outer, chemical-resistant, steel toe and shank.
 - Boot covers, outer, chemical-resistant (disposable) (optional).
 - Hard hat.
 - Escape mask (optional).

- Two-way radios (worn under outside protective clothing).
- Face shield (optional).

Level D

20. A work uniform affording minimal protection, used for nuisance contamination only. Equipment and clothing are as follows:

- Coveralls.
- Gloves (optional).
- Boots/shoes, chemical-resistant, steel toe and shank.
- Boots, outer, chemical-resistant (disposable) (optional).
- Safety glasses or chemical-splash goggles.
- Hard hat.
- Escape mask (optional).
- Face shield (optional).

CRITERIA FOR LEVELS OF PROTECTION

Level A

21. Level A protection should be used under any of the following conditions:

- Highest level of protection for skin, eyes, and the respiratory system based on either the measured (or potential for) high concentration of atmospheric vapours, gases, or particles.
- When the site operations and work functions involve a high potential for splash, immersion, or exposure to unexpected vapours, gases, or particles of material that are harmful to skin or capable of being absorbed through the intact skin.
- When substances with a high degree of hazard to the skin are known or suspected to be present and skin contact is possible.
- When operations must be conducted in confined, poorly-ventilated areas until the absence of Level A conditions is determined.

Level B

22. Level B protection should be used under any of the following conditions:

- When the type and atmospheric concentration of substances have been identified and require a high level of respiratory protection, but less skin protection.

- When the type and atmospheric concentration of substances do not meet the criteria for use of air-purifying respirators.
- When the atmosphere contains less than 19.5 per cent oxygen.
- When the presence of incompletely identified vapours or gases is indicated by a direct-reading organic vapour detection instrument.
- When the presence of liquids or particles is indicated, but they are known not to contain high levels of chemicals harmful to skin or capable of being absorbed through the intact skin.

Level C

23. Level C protection should be used under any of the following conditions:

- When the atmospheric contaminants, liquid splashes, or other direct contact will not adversely affect or be absorbed through any exposed skin.
- When the types of air contaminants have been identified, concentrations have been measured, and an air-purifying respirator is available that can remove the contaminants.
- When all criteria for the use of air purifying respirators are met (not appropriate where atmospheric concentrations of chemicals exceed safety levels, nor where the atmosphere contains less than 19.5 per cent oxygen).
- Atmospheric concentration of chemicals must not exceed OHS levels. The atmosphere must contain at least 19.5 per cent oxygen.

Level D

24. Level D protection should be used when both of the following conditions exist:

- The atmosphere contains no known hazard.
- Work functions preclude splashes, immersion, or the potential for unexpected inhalation of or contact with hazardous levels of any chemicals.
- The atmosphere where Level D protection is used must contain at least 19.5 per cent oxygen.

Note

- Not appropriate for personnel operating in the warm zone.

Medical Issues Related to CBR Clothing Usage

25. The consequences of wearing protective clothing relates to the inability to deal with the heat load generated by the body in an encapsulating suit. Adverse effects are:

- body temperature rises 1.5 times as fast;
- heart rate increases 80 per cent;
- endurance time is reduced by 60 per cent;
- weight loss is 40 per cent higher; and
- perspiration evaporation is halved

Major Problems Related to Wearing PPE in Heat

26. The major problems related to wearing PPE in heat are listed below. If ambient conditions are more extreme, the onset of symptoms will be more rapid. Major adverse effects are:

- a sudden, rapid rise in body temperature, leading to collapse (victim unaware, often fatal);
- steady loss of body water (one to two litres per hour not uncommon);
- slow, insidious loss of performance;
- recovery difficult in contaminated environment;
- clothing cannot be removed; and
- an adequate rate of drinking is not possible.

27. Table 1 shows the extent of water loss when wearing a charcoal suit compared with normal clothing.

Clothing Worn	Individual Water Loss (kg)	Water Lost to Atmosphere (kg)
Normal ^(a)	0.64	0.33
CBR Protective ^(b)	1.09	0.24

Notes

(a) *Long-sleeve shirt and long trousers.*

(b) *Encapsulating air-permeable military-style suit, air-purifying mask, impermeable gloves and overboots.*

Table 1: Average Amount of Water Lost by Participants Walking Briskly on a Treadmill for 25 Minutes

Source: DSTO, MRL Report No. 826 (1981). 'Defence Trial 6/425: Performance of Infantry Soldiers Wearing NBC Clothing in Hot/Humid and Hot/Dry Climates' by R.I. Tilley, H.D. Crone, B. Leake, R. I. Reed and V. Tantaro

HEAT STRESS

28. The wet bulb globe thermometer (WBGT) index determines the heat condition; this condition is assigned a number (1–5) or a corresponding colour code (white, green, yellow, red, black) that can be displayed with flags or other devices.
29. Protective gear increases the ambient WBGT index by about 5.5°C; (ie 5.5°C is added to the WBGT reading before the heat condition is designated).
30. Much of the information available on heat stress relates to wearing normal military clothing where the body is in effective contact with the surrounding air. In these circumstances the 'WBGT Index' gives a reasonable guide to environmental conditions and the amount and level of work that can be safely performed.
31. This is not the case when encapsulating protective ensembles are worn. Here the major contributor to build up of body heat is the work rate because the worker is cocooned in his or her own microenvironment inside the suit and external environmental conditions as characterised by the WBGT have little bearing. DSTO have found that for someone working at a moderate rate in a fully-encapsulating protective ensemble 20–30 minutes is the maximum time they can continue without risking the onset of heat illness.
32. The US National Institute of Safety and Health (NIOSH) recommended work/rest cycles are given in Table 2 below.

Work/Rest Regimen	Workload		
	Light WBGT (°C)	Moderate WBGT (°C)	Heavy WBGT (°C)
Continuous work	30.0	26.7	25.0
75% work, 25% rest each hour	30.6	27.8	25.6
50% work, 50% rest each hour	31.7	29.4	27.8
25% work, 75% rest each hour	32.2	31.1	30.0

Table 2: NIOSH Work/Rest Cycles

Fluid Intake

33. The recommended water intake per hour and physical activity for each condition is shown in Table 3. Individuals wearing butyl rubber aprons on the decontamination line while at full personal protection may experience an even greater heat load.

CRITERIA ^(a)	CONTROLS	PHYSICAL ACTIVITY FOR SOLDIERS
-------------------------	----------	--------------------------------

HEAT CONDITION COLOUR CODE	WBGT Index (°C)	Water Intake (L/HR)	Work/Rest Cycles Acclimatised Soldiers	Unacclimatised Soldiers and Trainees
1 / White	25.627.7	Min 0.5	Continuous	Use discretion in planning heavy exercise. Suspend strenuous exercise during first 3 wk of training.
2 / Green	27.829.3	Min 0.5	50 min work 10 min rest	Training activities may be continued on a reduced scale after 2 wk of training.
3 / Yellow	29.431.0	Min 1.0	45 min work 15 min rest	Avoid activity in direct Sunlight.
4 / Red	31.132.1	Min 1.5	30 min work 30 min rest	Curtail strenuous exercise for all personnel with <2wk of hot weather training.
5 / Black	□32.2	> 2	20 min work 40 min rest	Physical training and strenuous exercise are suspended. Can be suspended if situation is critical. Enforce water intake.

Note

- (a) Wearing fully protective clothing adds 5.5°C to the wet bulb globe thermometer (WBGT).

Table 3: Heat Categories and Work/Rest Cycles

Note

Tables such as those given above are only guides and are not substitutes for **personal monitoring** of workers for early warning signs of heat illness.

INDIVIDUAL PROTECTION—CHEMICAL

General

34. Individual protection is the first line of defence against chemical agent contamination. Individual protection comprises the respirator and protective clothing including gloves and boots.

Clothing

35. Full protective clothing is particularly important for persistent agents and agents that pose significant skin injury or skin penetration effects. It is preferable for the contamination to be on the disposable CBR suit rather than on clothing. Chemical agents may gain entry to the body through poorly fitting garments.
36. For agents posing a respiratory or eye injury threat exclusively, a full-face respirator would suffice. Individual protection imposes physiological and psychological stress on the individual, impairs communication, and reduces performance to a certain degree, depending on the individual's job performance requirements.

Respirator

37. The respirator protects against chemical agents. The respirator does not provide the same level of protection for all agents.

Immediate Action Drill

38. The best personal protection against the consequences of chemical agent incident is to wear full PPE. The first suspicion that a chemical agent incident has taken place should invoke the immediate action drill (IAD) without delay.

INDIVIDUAL PROTECTION—BIOLOGICAL

General

39. The CBR respirator, suit, gloves, and boots (Personal Protective Equipment [PPE]) will provide protection against a biological agent incident delivered by the aerosol route. While the PPE clothing employed against chemical agents will also protect against biological agents, it is important to note that even standard good quality uniform clothing affords reasonable protection against dermal exposure to biological agents.

CBR Clothing

40. The CBR suit will protect against arthropod inoculation but some arthropods, such as lice, could get through to the body if clothing does not fit properly. Some micro-organisms (*Brucella melitensis* and *Coxiella burnettii*) and all spores can remain on clothing either directly or as a contaminant of dust particles. It is preferable for this contamination to be on the disposable CBR suit rather than on clothing. Several organisms can gain entry to the body through minute skin surface abrasions and cuts, a common problem of vigorous field activities; protection may be provided by wearing the CBR rubber gloves.

Respirator

41. The respirator protects against biological agent aerosols. This aerosol consists of a droplet of protective/nutrient medium in which clumps of bacteria are present. Currently, field respirators equipped with standard CBR filter (HEPA) canisters will protect the respiratory system against sub-micron particles. While aerosol production itself is a simple matter, the production of droplets sufficiently small to defeat the respirator canister is not.

Responders

42. Personnel casualties unable to continue wearing PPE should be held and/or transported within casualty wraps designed to protect the patient against chemical or biological agent exposure. Addition of a filter blower unit to provide overpressure enhances protection and provides some cooling (if available).

Immediate Action Drill

43. The best personal protection against the consequences of biological agent incident is to wear full PPE. The first suspicion that a biological agent attack has taken place should invoke the immediate action drill (IAD) without delay.

INDIVIDUAL PROTECTION—RADIATION

General

44. The issues discussed above under both chemical and biological incidents are similar for radiation incidents. If there is particulate matter carrying radioactive particles then the suit and respirator will provide adequate protection from incorporation. However, **all personnel will need to be closely monitored by a Radiation Safety Officer (RSO)** to ensure that dosages of radiation beyond those levels set by Worksafe Australia are not exceeded. This may require discarding equipment for a new set at times set by the RSO.

Minimising Radiation Effects

45. As alluded to above, the suit and mask combination do not provide protection against radiation. The cornerstones of personal safety here are:
- radiation hazards decrease with distance from the source;
 - time in the vicinity;
 - source intensity; and
 - strict adherence to instructions given by the RSO.

PRE-TREATMENT AND PROPHYLAXIS—CHEMICAL AGENTS

46. Limited pre-treatment and/ or prophylaxis available in practice.

PRE-TREATMENT AND PROPHYLAXIS—BIOLOGICAL AGENTS

Aerosols

47. During a biological aerosol incident, the number of infectious or toxic units to which an individual is exposed may be greater than in the case of natural exposure. In addition, exposure by inhalation may represent an unnatural route of infection with many agents.

Prophylaxis

48. In striking contrast to medical defensive measures to counter the effects of radiation and many chemical incidents, there exists the potential to minimise the threat of biological warfare through employment of available prophylaxis and therapy directed against specific agents.

Immunoprophylaxis

49. Prophylactic immunisation is the only means of providing continuous protection against biological threats prior to, as well as during, an incident. Vaccines against a number of potential biological agents are available, and others are in various stages of development. Many of these vaccines were developed for the protection of laboratory workers, or individuals working where the target diseases are endemic. Details are as follows:
- The efficiency of protection afforded by most vaccines is based on normal (that is, under natural disease conditions) inoculum size and exposure. Vaccines that are generally considered effective under natural circumstances, may not provide a similar degree of protection to individuals exposed to biological aerosols. Indeed following a deliberate biological incident, the number of micro-organisms will be much greater than that occurring in a natural disease. This raised level of attack may overcome the resistance provided by immunisation. Immunisation is likely to be most effective for those personnel on the outer edge of an area where the number of micro-organisms has fallen to lower levels. Immunisation may also attenuate a disease process while not providing complete protection and it may protect secondary targets from transmissible disease.
 - Administration of vaccines to counter biological agents is complicated by the number of potential threats, the requirement to administer multiple doses of certain vaccines, the lead time necessary for stimulating immunity through vaccination, and the number of vaccines that can be administered simultaneously. The main factors to be considered are as follows:
 - A biological agent is less likely to be used if an effective vaccine exists against it. The routine use of an effective vaccine may prevent that agents use, unless further research is undertaken to overcome the protection provided by vaccination.

- Most viral biological incident agents are members of large virus groups with many subtypes and strains showing minimal cross-immunity. A large repertoire of vaccines would be required and would need to be given well in advance of an anticipated attack. These factors discount the use of conventional vaccines as effective protective agents.
- The logistical burden accompanying an in-incident vaccine administration program can be eliminated by immunisation of key responder personnel prior to routine duties, if that were thought appropriate. This requires formulation and implementation of an immunisation policy that should be driven by public health services in consultation with intelligence sources.
- Current or potential approaches to improving the efficiency of mass vaccination include:
 - * utilisation of the jet injector;
 - * administration of vaccines via the aerosol route;
 - * use of immunopotentiators to enhance responsiveness to vaccines;
 - * development of new vaccines to accelerate the immune response; and
 - * use of multivalent vaccines.
- Reaction to vaccines must be considered in the decision to implement a vaccination policy. Idiosyncratic reactions are associated with nearly all vaccines, but affect only a very small proportion of vaccines. The frequency and severity of reactions vary from vaccine to vaccine. With current products, significant side effects of immunisation generally occur infrequently.
- For some biological agents, the only available countermeasure might be specific antiserum. Under certain conditions, passive immunoprophylaxis with immunoglobulin products might be considered. Use may be limited by lack of adequate sources and quantities of material, limited duration of protection, and the risk of serum sickness associated with antisera not of human origin. However, recent scientific advances in products for immunoprophylaxis (for example, human monoclonal antibodies, 'despecciated' equine or bovine antisera) are making this option technically more attractive.

Toxins

50. In the case of protein toxins, immunity can be induced in some instances by vaccination with an inactivated form of the toxin (toxoid). It is possible that immunity to other toxins, which are not proteins, could be produced by using a conjugate of the toxin with an antigenic protein, although this is still in the research stages.

Chemoprophylaxis

51. Chemoprophylaxis using broad-spectrum antibiotics offers an additional option in the setting of a biological incident threat. If an incident is felt to be imminent, or is known to have occurred, directed chemoprophylaxis would be appropriate for all personnel in the area. However, it is impractical, wasteful, and dangerous to place everyone located in a potential target area on prolonged, routine prophylactic antibiotics in the absence of such a threat condition. Further considerations are as follows:
- For some biological agents, administration of antibiotics following exposure, but prior to appearance of symptoms, may be life-saving.
 - Knowledge of incubation periods and disease pathogenesis must be considered in the rationale and timing for dose and schedule of administration for a given drug. In some cases (for example inhalation anthrax), coupling antibiotics with the post-exposure use of vaccine (if available) may offer the best alternative in those previously unvaccinated.
 - In other cases, administration of antibiotics at certain times following exposure serves only to prolong the incubation period (eg Q fever).
 - One must therefore be cautious in generalising in the decisions to employ post-exposure prophylaxis. However, there may be occasions during an incident when, even though it is known that prophylactic antimicrobial use will not fully prevent clinical disease, there remains a justification for use. If, for example, an antibiotic suppressed disease sufficiently long for the exposed individual to accomplish the task or reach appropriate medical support, it would still be useful.
 - There are many diseases, including the majority of viral diseases and intoxications, for which chemoprophylactic measures are either unavailable or ineffective.

PRE-TREATMENT AND PROPHYLAXIS—RADIOLOGICAL AGENTS

52. See Chapter 15 for a more detailed discussion of radiation effects.

CASUALTY PROTECTION

53. Casualties will require continued protection in a contaminated environment. This may entail the use of individual protection, specialised casualty bags or hoods, and collective protection.

Head Wounds

54. Head wounds, after being attended to and dressed will necessitate the casualty being evacuated in a casualty bag or half bag or hood. In emergency the

casualty's head may be protected in an impervious blouse from a spare protective suit.

Heat Stress

55. The use of individual protective equipment and casualty bags imposes a significantly greater heat stress upon the individual. In warm environments and at moderate work rates personnel are susceptible to heat injury. The Medical Officer's responsibilities will include providing advice to the Commanders about work/rest cycles and of the need for increased fluid intake. Further information on the management of heat stress is available in the annexures to this section.
56. Medical attendants need to be especially aware of the need to replace fluids in casualties wearing individual protective equipment. Protective equipment makes monitoring casualties difficult and a high index of suspicion for heat stress must be maintained at all times.

COLLECTIVE PROTECTION OF HEALTH UNITS

General

57. Collective protection (Colpro) is desirable, particularly for health care. Adequate Colpro may not be possible, or may be difficult to achieve and will require personnel and equipment resources.
58. Colpro provides the capability to medically manage severely toxic or injured decontaminated casualties in an environment where health personnel are not encumbered by wearing individual protective equipment. Likewise, the casualties benefit from the capability of the health unit to make full use of available medical equipment and procedures.

Chemical

59. Chemical casualties usually require full Colpro. In some instances, it may be feasible to establish a vapour only hazard area, and work within that area at less than full individual protection, such as using respiratory and eye protection. Limited health care can be achieved in this manner, but full examination and definitive surgical treatment is impossible without full Colpro. A significant percentage of casualties (15–30 per cent) can not be adequately treated in a contaminated environment without Colpro as their treatment requires the removal of their respirator.

Biological

60. A dedicated hardened or unhardened shelter equipped with an Air Filtration Unit (AFU) providing overpressure can offer Colpro for personnel in the biologically-contaminated environment. An airlock ensures that no contamination will be brought into the shelter. Casualties and contaminated personnel must be decontaminated prior to entering Colpro. In the absence of a dedicated structure, enhanced protection can be afforded within most buildings by sealing cracks and entry ports, and providing air filtration within existing ventilation systems.
61. Due to the requirement to continue operations in a contaminated environment, much medical treatment will likely take place in Colpro. Colpro is the most

effective method for protecting patients and the health capability in the contaminated environment. Patients whose illness is thought to be the result of a biological attack, or those who are thought to have a contagious infectious disease, will necessarily be cared for using current infection control techniques (which may necessitate full PPE) while inside the Colpro system.

62. The use of Colpro equipment for patients with transmissible disease can only be considered if the Colpro is not required for other patients. Patients could only be treated in Colpro if the health staff were in full PPE as the Colpro facility could become contaminated with biological agent.
63. Patients who have abrupt onset febrile illnesses or are prostrated, and whose illness is thought to be the result of a biological agent incident, should not be allowed into Colpro used for other non-biological agent patients. They should be treated in an isolation ward by staff wearing full PPE until it is certain that the disease is non-transmissible. Note: in the case of a biological incident there may be no 'site' and the first knowledge will come from patients self presenting.

PROTECTION OF HEALTH CARE PERSONNEL

64. Following decontamination, patients are cared for using standard nursing management techniques including universal infectious disease precautions. Protection of health personnel is offered through use of impermeable surgical gowns/oral-nasal masks/face shields or goggles/surgical gloves and observance of universal (body fluid) infection control guidelines.
65. Significant risk for person-to-person spread may exist for individuals not directly involved in patient care. In particular, materials soiled by patient secretions and excreta, as well as samples for diagnostic laboratory study must be clearly identified as hazardous and appropriate handling procedures applied.
66. Similarly, invasive medical and surgical procedures pose potential risks. It must be emphasised, however, that not all biological agents pose a hazard for secondary transmission. For example, clinical laboratory samples from toxin-exposed subjects can be dealt with routinely.
67. Patients showing signs of pneumonic plague generally should be considered hazardous, as some will disperse plague bacilli by aerosol. Although cutaneous anthrax may result from contact with blood or other body fluids contaminated with vegetative anthrax bacilli, exposure of health care providers to open lesions or blood from anthrax patients does not pose a risk of inhalation anthrax. Bacilli exposed to air, however, will sporulate (after a period of hours). This will pose a subsequent theoretical risk for inhalation anthrax. On the other hand, vegetative forms of plague bacilli may be dangerous, since, under some circumstances, they are known to cause aerosol infections. Therefore, post mortem examinations of victims of transmissible biological agents should be performed using barrier techniques, with appropriate consideration given to specific respiratory protection.

Annexes:

- A. Problems with Protective Garments
- B. Medical Monitoring of Personnel in PPE
- C. Prevention and Treatment Protocol for Heat Stress in Hazardous Materials Team Members

PROBLEMS WITH PROTECTIVE GARMENTS

Decrease in performance as evaporation stops.

Skin irritation.

Distraction may result in an increase in accidental injuries, breaches in protection, and decrease in performance.

Anxiety may cause psychological casualties.

Loss of socialisation and communication heightens the anxiety. No verbal, tactile visual contact with friends.

Until one has abundant experience with either a respirator or self-contained breathing apparatus the increased effort of respiration becomes an annoyance.

High humidity and an occlusive protective garment increase risk of heat exhaustion and heat stroke. (Unable to shed heat load.)

The medical team must constantly monitor the team members for such signs of heat stress. (Telemetry may be available in some places.)

Drinking is possible with only a few of the protective mask designs.

Damaged or improperly donned protective clothing will allow entry of contaminants with potentially disastrous results.

Improper protective garments will afford little or no protection.

MEDICAL MONITORING OF PERSONNEL IN PPE

DEFINITION

Medical monitoring is the ongoing, systematic evaluation of response personnel who are at risk of suffering adverse effects of heat/cold exposure, stress, or hazardous materials exposure.

OBJECTIVES

Medical monitoring is performed at the site of a hazardous materials incident to:

- obtain baseline vital signs and physical assessment;
- identify and exclude from the hot zone and warm zone any individuals at increased risk of injury and illness as a result of working at the scene; and
- provide early recognition and treatment of personnel with adverse physiological responses as a result of on scene activities.

Pre-entry medical monitoring should be completed on all individuals wearing chemical liquid splash and vapour protective clothing and performing hazardous materials operations. It should be completed within one hour prior to entry.

Components of Pre-Entrance Medical Monitoring

Completed for each re-entry in addition to the initial entry and exit.

- **Vital Signs**—Evaluation of the following vital signs:
 - Blood pressure.
 - Pulse.
 - Respiratory rate.
 - Temperature.
 - ECG rhythm strip (10 seconds), if available.
- **Skin Evaluation:**
 - Rashes.
 - Open sores/wounds.
- **Mental Status:**
 - Alert and oriented to time and place.
 - Clear speech.
 - Normal gait.

- Able to respond appropriately to the situation.
- **Medical History**—A medical history should be obtained:
 - Medications, including over the counter, taken within the last 72 hours.
 - Alcohol consumption within the last 24 hours.
 - Any new medical treatment or diagnosis made within the past two weeks.
 - Symptoms of fever, nausea, vomiting, diarrhoea, or cough within the last 72 hours.
- **Weight**—The individual's weight should be recorded.
- **Hydration**—It should be determined whether the individual has consumed 300–600mls of water or diluted activity drink.
- **Exclusion Criteria**—Nature and duration of any exposure.
 - Blood pressure diastolic greater than 105mm Hg.
 - Pulse greater than 70 percent maximum heart rate (220-age).
 - Respiratory rate—greater than 24 per minute.
 - Temperature greater than 37.5°C (oral) or greater than 38°C (core) or less than 36°C (oral) or less than 36.5°C (core).
 - Weight no pre-entry exclusion.
 - ECG dysrhythmia not previously detected (must be cleared by medical control).
 - Skin evaluation—open sores, large area of rash or significant sunburn.
 - Mental status altered mental status (ie Slurred speech, clumsiness, weakness).
 - Recent medical history including:
 - * nausea, vomiting diarrhoea, fever, URTI, heat illness, or significant alcohol intake within past 72 hours, (causes of dehydration);
 - * new prescription medications taken within past two weeks or over-the-counter medications such as cold, flu, or allergy medicines, taken within past 72 hours (must be cleared through local medical control or hazardous materials medical director);
 - * any alcohol within past six hours; or
 - * pregnancy.

- **Components of Medical Monitoring During Entry:**
 - Changes in gait, speech, or behaviour that require entry personnel to undergo immediate decontamination, removal of protective clothing and assessment.
 - If entry personnel complain of chest pain, dizziness, shortness of breath, weakness, nausea, or headache, they should undergo immediate decontamination, removal of protective clothing, and assessment.
- **Post-entry Medical Monitoring**—The objective is to establish whether an individual has suffered any immediate effects and his/her health status for future assignment during or following the incident. (This assessment should include both physiological and psychological considerations.)
- **Components of Post-Entry Medical Monitoring:**
 - History of any symptom of hazardous material exposure, environmental exposure, or cardiovascular collapse.
 - Vital signs:
 - * Blood pressure.
 - * Pulse.
 - * Respiratory rate.
 - * Temperature.
 - * ECG test (if available).
 - Weight.
 - Skin evaluation.
 - Mental status.
- **Post-Medical Monitoring Follow-Up:**
 - Repeat monitoring of vital signs every 5–10 minutes until they return to less than 85 per cent of maximum pulse rate. If at 10 minutes the signs have not returned to within 10 per cent of baseline, perform orthostatic vital sign.
 - Determine from medical control what information regarding latent reactions/symptoms should be communicated to response personnel.
 - If any of the following symptoms are present, contact medical control for direction and preparation for possible transport to a medical facility:

- * Body weight loss of greater than 3 per cent or positive orthostatic changes (pulse increase by 20 beats per minute or systolic blood pressure decrease by 20 mm of Hg at two minutes standing).
- * Greater than 85 per cent maximum pulse at 10 minutes.
- * Temperature greater than 38.3°C (oral) or 38.8°C (core).
- * Nausea, vomiting, diarrhoea, altered mental status, or respiratory, cardiac, or dermatological complaints.

PREVENTION AND TREATMENT PROTOCOL FOR HEAT STRESS IN HAZARDOUS MATERIALS TEAM MEMBERS

Rest time should equal at least minimum suit time.

Add extra time for oral re-hydration.

Inform of signs and symptoms to watch for.

If vital signs not within 10 per cent of baseline within 10 minutes, orthostatic vital signs should be taken.

If greater than three per cent body weight loss.

If positive orthostatic pulse (increases by 20 beats per minute).

If systolic blood pressure decreases by 20 mm of Hg at two minutes standing.

If pulse greater than 85 per cent of maximum at 10 minutes.

If temperature greater than 38.3°C oral or 38.8°C core.

If nauseated.

If mental state altered.

If any other symptoms.

The following should be performed:

- Intravenous fluid Ringers Lactate or Normal Saline at rate (usually wide open) to get pulse less than 100 beats per minute, systolic blood pressure greater than 110 mm of Hg.
- Oxygen 4 to 6L per minute.
- Consultation of reference protocols or medical control for treatment of specific symptoms/types of exposure.
- Consider Oral or IV glucose.

CHAPTER 5

TRIAGE

INTRODUCTION

1. Triage is the process by which disaster casualties are sorted, prioritised, and distributed according to their need for first aid, resuscitation, emergency transportation, and definitive medical care. Triage is a continuing process which begins in the field and continues into the hospitals and involves the matching of victims' needs with available resources in order to achieve the best outcome for the greater number of casualties.

PRINCIPLE

The aim of triage is to achieve the greatest good for the greater number of casualties.

OBJECTIVE

2. The objective of triage is to minimise the death and suffering that is the result of a disaster. This is achieved by ensuring that available health resources are directed to those who will receive the greatest benefit. As a corollary, response effectiveness demands that limited resources not be applied to victims with very low (or nil) survival probability.

TIMING

3. Triage is a dynamic process, as the state of the patient may change, either as a result of injuries worsening, or because of interventions. To be effective, triage must be repeated many times, which may include:
 - when the casualty is first seen;
 - before movement from the incident site;
 - within the forward treatment area;
 - before transportation to hospital;
 - on arrival at the hospital before surgery. In addition, reassessment will be necessary; and
 - whenever the casualty's condition is noted to have altered.

PRINCIPLE

Triage is the continuing process which commences on the field and continues into the hospital.

PERSONNEL

4. Accurate triage, by implication, necessitates experienced medical judgement. It should always be carried out by the most clinically skilled and experienced person present. Over the course of a disaster, the person doing triage may change from an ambulance officer to a senior medical clinician.

PRIORITIES

5. Effective triage requires the identification of different priority groups. While casualties may differ in their severity within these groups, initial sorting and treatment can at least occur. While triage categories may differ slightly between States/Countries, generally accepted categories are as follows:
 - **First Priority (Red)**—Life threatening injuries in need of urgent medical care, requiring priority transport, with or without appropriate resuscitation.
 - **Second Priority (Yellow)**—Significant injuries, condition stable and treatment can wait. Or for casualties not expected to live, or whose resuscitation may over-utilise available resources and prejudice the survival of other patients.
 - **Third Priority (Green)**—Walking wounded who may not require ambulance transport according to priorities, to treatment centres. Casualty will not require hospitalisation. Psychological casualties are included in this category.
 - **Deceased (Black/white)**—Used for the dead.

THE 'EXPECTANT' CATEGORY

6. In addition to the above categories, it is also well recognised that there are some casualties whose injuries are so severe that they either will not survive, or they will drain excessive resources to the detriment of large numbers of other casualties. These may include the following:
 - Any person in cardio-respiratory arrest.
 - Any person with a Glasgow Coma Score of 3 (no eye opening, no verbal or motor response)
 - Major burns where age >60 years and body surface area burned >50%. As a general rule, if (age + % BSA burned) >100, mortality approaches 1.0.
 - Elderly persons with shock and multiple, severe injuries (especially CNS and thoracic).
7. The decision to establish this category should be made by the senior ambulance/medical officers on site, and will depend on factors such as the level of resources available at the scene, evacuation resources (including time and distance), and the resources available in hospital. In addition, consideration needs to be given as to at what stage should such casualties be given treatment/evacuation (for example, after priority 2's but before priority 3's).
8. It is essential that all health care providers who attend the site use the same priority groups (including expectant category if required), and the same criteria for categorising casualties into these priorities.

THE PROCESS OF TRIAGE

9. Where resources allow, the assessment and management of casualties should follow the 'ABCDE' approach as outlined in the Early Management of Severe Trauma (EMST) course of the Royal Australasian College of Surgeons, and the Trauma Nursing Core Course (TNCC) of the Emergency Nursing Association. This is a system of individual assessment and concurrent management.
10. In a situation where there are an overwhelming number of casualties (ie resources do not allow), triage has to be undertaken in isolation, sorting as many casualties as possible according to need, as quickly as possible. Additional personnel then undertake appropriate resuscitation measures, treating casualties in order of assigned triage priorities.
11. In such a situation, a number of methods of rapid triage for mass casualties have been developed. In general terms, these methods usually involve rapid identification of the 'walking wounded' (Priority 3) and the deceased (Priority 4), and then use easily applied parameters to quickly sort the remaining casualties. To be effective, such methods need to be applicable in the field, related to mortality, and be easily reproducible.
12. An example of rapid triage method is the Triage Sieve/Triage Sort, as advocated by the Major Incident and Medical Management and Support (MIMMS) course of the Advanced Life Support Group, UK. This operates on the following algorithm:

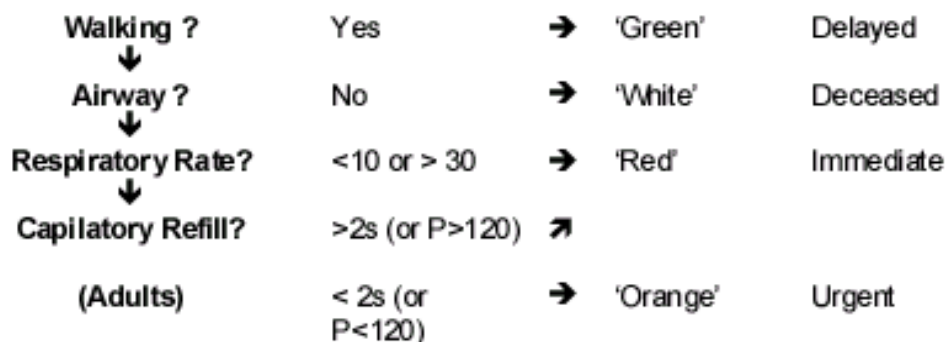

After the initial 'sieve' a more detailed 'sort' is conducted utilising the Triage Revised Trauma Score (respiratory rate, systolic blood pressure and GCS), as well as available anatomical considerations.

13. Triage tags are used to indicate the category in which the patient has been placed. The triage tag forms the initial medical record and must not be removed until admission to hospital or area of definitive care. The tag must then be incorporated into the medical record.
14. Identification of categories is likely to be most effective where at least two different methods are used ie: casualties are tagged as well as geographically co-located.

TRIAGE AT THE SITE

15. Effective triage at the site is essential to ensure that immediate treatment can be delivered to those who will most benefit from it, and so that priorities for evacuation can be readily assigned.
16. Arrangements for the management of triage at the site will generally be an ambulance responsibility and involve the establishment of a medical incident management system. Field Medical Teams will work in conjunction with ambulance and first aid personnel, under the control of the Field Medical Commander, who will liaise with the Ambulance Commander.

TRIAGE AT THE HOSPITAL

17. In many disasters a significant proportion of casualties may make their way to the nearest hospital without having been triaged at the site. Patients arriving at hospital should be triaged at the entrance to the Emergency Department by an experienced doctor/emergency nurse and then allocated to appropriate designated areas (Resuscitation, Urgent, Ambulatory).
18. Effective triage at the hospital allows for priorities to be established for resuscitation, operating theatre access, intensive care and transfer as appropriate to subspecialty areas (such as neurosurgery/spinal).

PRACTISING TRIAGE

19. Practising to triage in a mass casualty situation is difficult to totally replicate, and suffers from the usual constraints in terms of trying to simulate a 'life or death', pressure situation. Options may include field exercises (involving role-playing casualties), card exercises (ie utilising SIMCAS cards) or computer simulations.

SUMMARY

20. Triage is a clinical decision making process by which disaster casualties are sorted, prioritised and distributed according to their need for first aid, resuscitation, emergency transportation and definitive medical care.
21. Triage is dynamic and should commence with the first medical responder and continue through to the hospital.
22. Accurate triage is the key to ensuring that limited resources are used for maximum benefit in a mass casualty situation
23. With multiple casualties, it may be necessary to adopt a system of rapid triage. This will generally involve rapidly sorting casualties utilising mobility and identifying those casualties with poor outcomes. By necessity, this sorting is crude and to be effective needs to be regularly repeated.

REFERENCES

24. References used in this Chapter are as follows:

- Kennedy et al, Triage: **Techniques and Application in Decision Making**: Annals of Emergency Medicine 28:12, August 1996, pp. 136-144
- Trauma Committee, Royal Australasian College of Surgeons, **Early Management of Severe Trauma (EMST) Course Manual**.
- The Committee on Trauma, American College of Surgeons, **Advanced Trauma Life Support (ATLS)**.
- Emergency Nursing Association, **Trauma Nursing Core Course (TNCC) Manual**.
- Advanced Life Support Group, **Major Incident Medical Management and Support, the Practical Approach**.

CHAPTER 6

DECONTAMINATION

GENERAL

1. Decontamination is defined as the reduction or removal of substances so they are no longer hazards. The overriding principle with any hazardous material is to assume it is dangerous. As in daily work with body substance precautions, remember personal protection and do not walk through contaminated sites or touch obviously contaminated surfaces.
2. Substances may be removed by physical means or be neutralised chemically (deactivation). Decontamination may be required for equipment, vehicles, the environment and people. In relation to the latter it may be external (skin, eyes and wounds) and/or internal (eg GIT or blood).
3. When discussing decontamination the following terms are frequently used:
 - **Personal**—Decontamination of oneself.
 - **Casualty**—Decontamination of casualties.
 - **Personnel**—Decontamination of responders.
 - **Equipment**—Decontamination of equipment used by the responders.
 - **Personal Belongings**—Decontamination of personal belongings of the casualty such as glasses, watches and jewellery.
4. The decontamination of vehicles, materials, buildings and terrain does not come within the framework of this manual. One of the most difficult aspects of a chemical incident is that the chemical agent/s may persist in the environment for extended periods of time. This is especially true of agents such as VX, the mustards, thickened GB or GD which may remain as contact hazards for hours or days in cold environments. In the hot wet or hot dry environments the persistence of agents is more likely to be minutes or hours depending upon the type of agents. All liquid chemical agents will have a vapour hazard associated with them.
5. Whilst decontamination for chemical, biological and radiological agents are similar, it is chemical decontamination that presents some of the greatest challenges to health care providers.
6. This chapter provides a description of the general principles, as applied to chemical contaminants and then specific information regarding each of the three categories. What is important throughout, is to ensure that trained personnel who are familiar with the established local procedures conduct decontamination. A well-devised procedure, regularly rehearsed, will be the greatest safeguard to both patients and personnel.

7. On the site of a chemical incident, three types of environments may exist:
 - an uncontaminated environment where there are no chemical agents present;
 - a contaminated vapour-only environment, for example in a downwind hazard area; and
 - a contaminated environment where chemical agents are present in a liquid state or an absorbed state (ie in rubber, elastomer, equipment cracks and crevices) presenting a surface contact hazard and a vapour hazard.
8. In biological and radiological incidents the issues are:
 - similar for uncontaminated areas;
 - usually reduced for the airborne hazard however, this is related to how the substance was dispersed eg airborne particulate matter may be radioactive; and
 - similar for the environment.
9. Complete decontamination of a contaminated environment may be difficult or impossible. However, it is possible to achieve sufficient decontamination, particularly of liquid agent in small areas, to create a vapour only hazard area. Thus it may be possible to decontaminate equipment so that no further liquid surface contact hazard exists, even though chemical agent vapours may continue to be off-gassed from agent adsorbed onto or absorbed into the surface.
10. In such environments, it may be possible to work without the full protective clothing ensemble, although respiratory and eye protection would still be required. This is because most agents in a vapour state penetrate through the skin very slowly. However, mustard at high vapour concentrations may still cause skin injury, particularly if the skin surface is wet or moist, as may be the case in a warm environment.
11. Where a liquid hazard exists, decontamination of skin and eyes must be accomplished quickly if it is to be effective. Chemical agents may penetrate or react with the skin and eyes within minutes, so successful decontamination must be carried out immediately after exposure. Once the agent has been removed, or has been absorbed, no further risk of contamination exists. The casualty's body fluids, urine or faeces do not constitute a chemical hazard.
12. In the presence of a threat, equipment and supplies should be kept in unopened, sealed or covered containers until required for use. The use of a Chemical Agent Resistant Material (CARM) or heavy-duty plastic sheeting will provide good protection against liquid contamination, but even the use of tentage will significantly reduce contamination by a liquid agent for a limited period. The aim is to prevent liquid agent contact. Vapour may penetrate the plastic or tentage but will not impact significantly on the equipment.

DECONTAMINATION PRINCIPLES

13. The goals of decontamination are:

- hazard containment;
- prevention of worker exposure and contamination, as occupational health and safety issues are paramount for the responders;
- decontamination of:
 - personnel;
 - victims; and
 - equipment;
- tracking of contamination and casualties;
- monitoring casualties, personnel, and equipment for contamination;
- clean-up of contaminated equipment and personnel;
- use of appropriate personal protective equipment (PPE), disposable being ideal;
- use disposable equipment where possible; and
- protection of monitoring and sampling instruments.

SITE SELECTION

14. When an incident occurs, two questions should be asked. Is decontamination necessary? How much can be achieved at the scene?

- The issues that will influence those decisions are the:
 - nature of the incident;
 - number of victims;
 - location of the victims;
 - extent of injuries;
 - weather and geography;
 - resources available;
 - ability and time to resupply; and
 - suitability of the equipment on site.

15. It should be remembered that decontamination at hospitals or elsewhere will compound the problem and has the potential to contaminate multiple areas and vehicles.

SITE MANAGEMENT (also see Figure 1 and Chapter 2)

16. Site managers should observe the following points:

- The site must be a safe distance from the hot zone.
- Responder safety is an absolute priority.
- A log of all personnel responding to contaminated areas should be kept.
- Easy access to specialists in the field must be available.
- The site must be upwind of the incident.
- It must be uphill to ensure run off does not contaminate the clean area.
- It must have a predetermined agreement regarding activities and responsibilities within the hot, warm and cold zones.
- It must have an easily and quickly erected decontamination facility.
- Equipment for patient decontamination must be easy to clean (eg plastic wading pools or plastic patient slides supported by trestles). Normal beds or canvas NATO litters will become contaminated.
- Transport vehicles, especially ambulances, must be chosen carefully as they could become contaminated.
- Run-off must be contained to protect the environment.
- Weather conditions may add to problems (eg wind and cold).
- The site must be large enough to allow privacy for casualties.
- It must have a sufficient water (ideally heated) supply.
- In addition hospitals should ensure the above plus.
- The location is as near as possible to the emergency department.
- Provision is made for an area where resuscitation and decontamination can occur simultaneously.
- Air handling systems do not entrain fresh air from the decontamination site.

THE DECONTAMINATION PLAN

17. The decontamination plan should address such factors as the following:

- Site layout.
- Decontamination methods required.
- Equipment required.

- Number of personnel required.
- Level of protective clothing and equipment required.
- Disposal methods required.
- Containment of the run-off.
- Health care requirements.
- Methods required for collecting and disposing of contaminated clothing and equipment.

DECONTAMINATION TECHNIQUES

General

18. Decontamination techniques depend on the:

- injuries to the victims;
- nature of the agent;
- weather;
- equipment available;
- physical and chemical properties of the materiel;
- potential for exposure; and
- location of the exposure.

19. Physical removal of the agent can be achieved by the following methods:

- Removal of clothes.
- Brush, scrape and wipe techniques.
- Dilution: (Using water contra-indicated with metals such as sodium, potassium and lithium). When animal skin contaminated with the nerve agent GB was flushed with water for two minutes (a method in which physical removal predominates over hydrolysis of the agent), 10.6 times more GB was required to produce the same mortality rate as when no decontamination occurred.
- Adsorption: (Using powders such as Fuller's earth). Adsorption refers to the formation and maintenance of a surface bonding between the substance and the decontaminant. Whilst this bond (not a chemical bond) is maintained, the substance cannot be absorbed and is thus not active. In emergency situations:
 - dry powders such as soap or detergents, earth, and flour may be useful; and
 - flour applied, followed by wiping with wet tissue paper is reported to be effective against the nerve agents soman and VX and against mustard.
- Vacuuming (difficult in field).
- Showering.

20. Chemical removal (examples of which include; adsorption, chemical degradation, disinfection, sterilisation, solidification and dissolving) of the agent requires another chemical for the process of neutralising.

Neutralising

21. The most important category of chemical decontamination reactions is oxidative chlorination. (See Figure 1 and Annex D). The following details apply:

- The term covers the 'active chlorine' chemicals like hypochlorite.
- The pH of a solution is important in determining the amount of active chlorine concentration. An alkaline solution is advantageous.
- Hypochlorite solutions act universally against the organo-phosphorus and mustard agents.
- The use of a 0.5 per cent sodium or calcium hypochlorite solution for decontamination of skin and a five per cent solution for equipment.
- Chemical hydrolysis reactions are of two types: acid and alkaline.

- Acid hydrolysis is of negligible importance for agent decontamination because the hydrolysis rate of most chemical agents is slow, and adequate acid catalysis is rarely observed.
- Alkaline hydrolysis is initiated by the nucleophilic attack of the hydroxide ion on the phosphorus atoms found in VX and the G agents.
- The hydrolysis rate is dependent on the chemical structure and reaction conditions such as pH, temperature, the kind of solvent used, and the presence of catalytic reagents.
- The rate increases sharply at pH values higher than 8 and increases by a factor of four for every 10°C rise in temperature.
- Several of the hydrolytic chemicals are effective in detoxifying chemical warfare agents; unfortunately, many of these (eg sodium hydroxide) are unacceptably damaging to the skin. Alkaline pH hypochlorite hydrolyses VX and the G agents quite well.
- Mustard and the persistent nerve agent VX contain sulfur molecules that are readily subject to oxidation reactions. VX and the other nerve agents (tabun, sarin, and soman contain phosphorus groups that can be hydrolysed. Therefore, most chemical decontaminants are designed to oxidise Mustard and to hydrolyse nerve agents.

Dissolving

22. The following points should be noted:

- Both fresh water and seawater have the capacity to remove chemical agents.
- The predominant effect of water and water/soap solutions is the physical removal and/or dilution of agents; however, slow hydrolysis does occur, particularly with alkaline soaps. There may still be a problem with disposing of the active run-off.
- Reduce the surface tension of the agent.
- Beyond the substances provided for decontamination expert assistance should be sought on the physio-chemical management of the agent.

Additional Issues

23. The following points may need to be considered:

- **Biological**—Deactivation of biological agents has not been developed to the point of being practical at the time of publication.
- **Isolation or Disposal**—Radioactive contamination of clothing and equipment usually requires isolation of these items for appropriate long-term storage. (EPA and/or radiation safety experts should be consulted).

PERSONNEL DECONTAMINATION (see Figure 2)

24. Generally, the process for personnel involved is:

- move well away from the contaminated area;
- remove the agent from the skin and clothing by;
 - use of absorbent powders;
 - shower with detergent/soap and water;
- if wearing PPE, remove the protective CBR dress correctly (with minimal handling of outside of PPE) and additional under clothing;
- finally shower with detergent;
- redress;
- monitor health effects;
- maintain a log of personal protective equipment used.

Note

Environmental and/or public health experts may need to be consulted regarding confinement and the appropriate disposal methods for collected decontamination fluids and personal protective equipment.

CASUALTY DECONTAMINATION (See Figure 3)

25. The goal of casualty decontamination differs from personal and personnel decontamination. In addition to preventing exposure of the agent, casualty decontamination also has the goal of preventing exposure of health care personnel and facilities to contaminated casualties. Generally the process is;

- wet;
- strip;
- wash; and
- redress.

26. The requirement for casualty decontamination will be a function of the agent used, environmental factors, and particularly time. Liquid chemical agents on the skin may react with or penetrate it rapidly. The Chemical Agent Monitor (CAM) is valuable aid in the decontamination process however, it should not be relied on for monitoring low levels of contamination. The CAM does not have sufficient sensitivity to permit long term unmasking. More sensitive detection systems, such as the C2 kit, should be used for this.

27. Radiological survey meters are employed to detect radiation. Biological materials cannot be easily identified in the same manner (although there are

systems being developed), however, samples taken at the time will subsequently confirm the presence of an agent.

- 28.** It is imperative that at least limited decontamination is performed as soon as possible. This will diminish the chance of re-contamination of the casualty, or contamination of health personnel and facilities from any agent left on the clothing or equipment. Given the time it takes to evacuate casualties, the quantity of liquid agent on the skin or clothing will have diminished or even disappeared due to evaporation. Often careful removal of the clothing and equipment, with spot decontamination of skin areas that may be at risk of re-contamination when the clothing is removed, will be just as effective as full decontamination, and can be accomplished more quickly and with fewer personnel.
- 29.** Protecting a wound from any further contamination with protective dressings is desirable. Further management of wounds should follow normal treatment procedures.
- 30.** The hazard of off-gassing of chemicals and further contamination from clothing and/or equipment removed from contaminated casualties requires that these items be disposed of properly. Several methods may be utilised for this purpose, such as impermeable bags or containers, bleaching powders or containers with charcoal granules. Final destruction may be by incineration or burial with bleach slurry.

Notes

- Shuffle pits are provided at the entry and after exit of the decontamination zone. These are provided to decontaminate footwear. This point should be remembered in normal daily practice where footwear protection is frequently forgotten when entering protected zones eg isolation areas for infectious diseases.
- For biological decontamination of facilities (offices/rooms etc) the use of formalin or hypochlorite is detailed in each State/Territory infection control plan. This information should be made available to other services such as fire.
- Wound decontamination is discussed in more detail later in this chapter at paragraph 40.

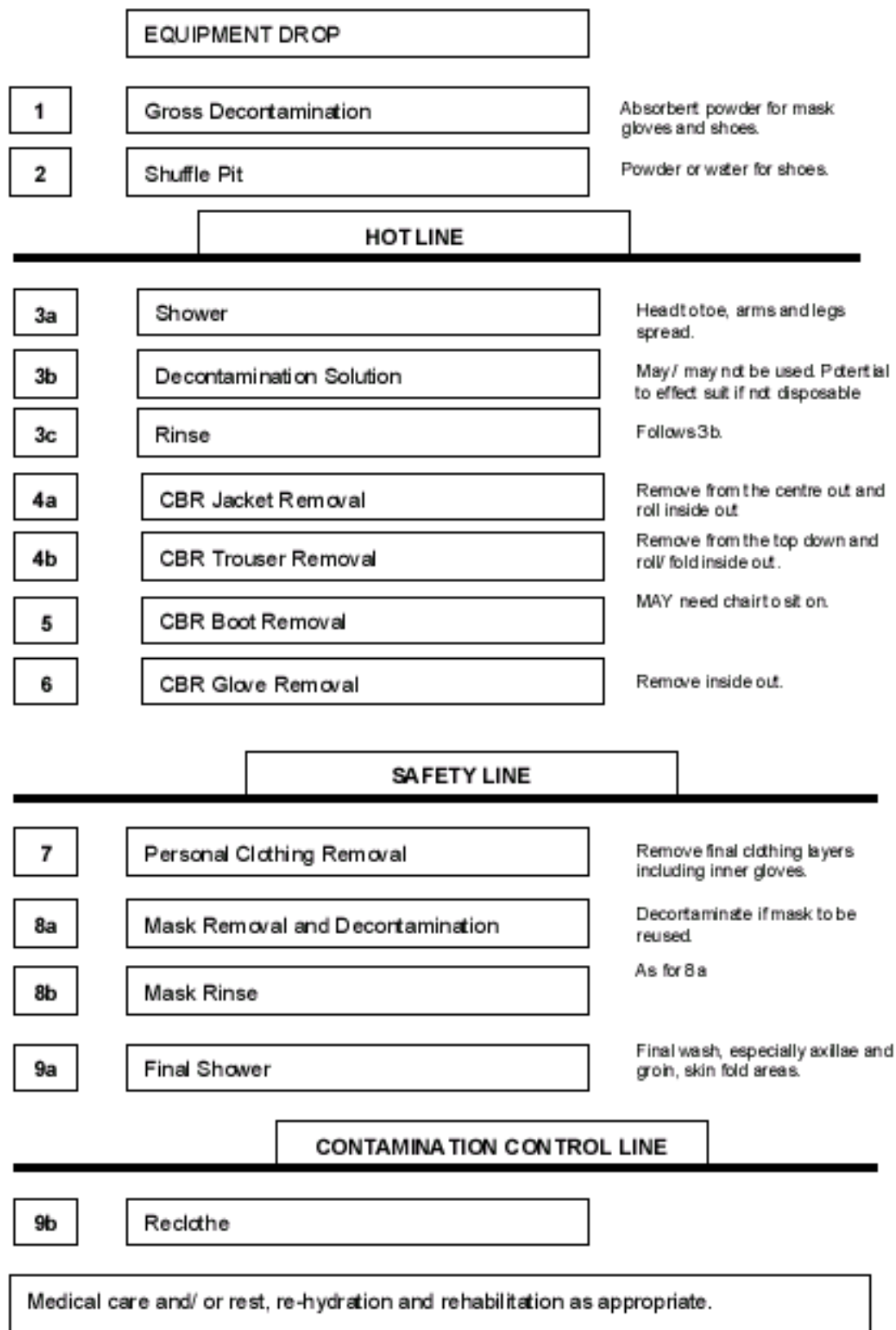
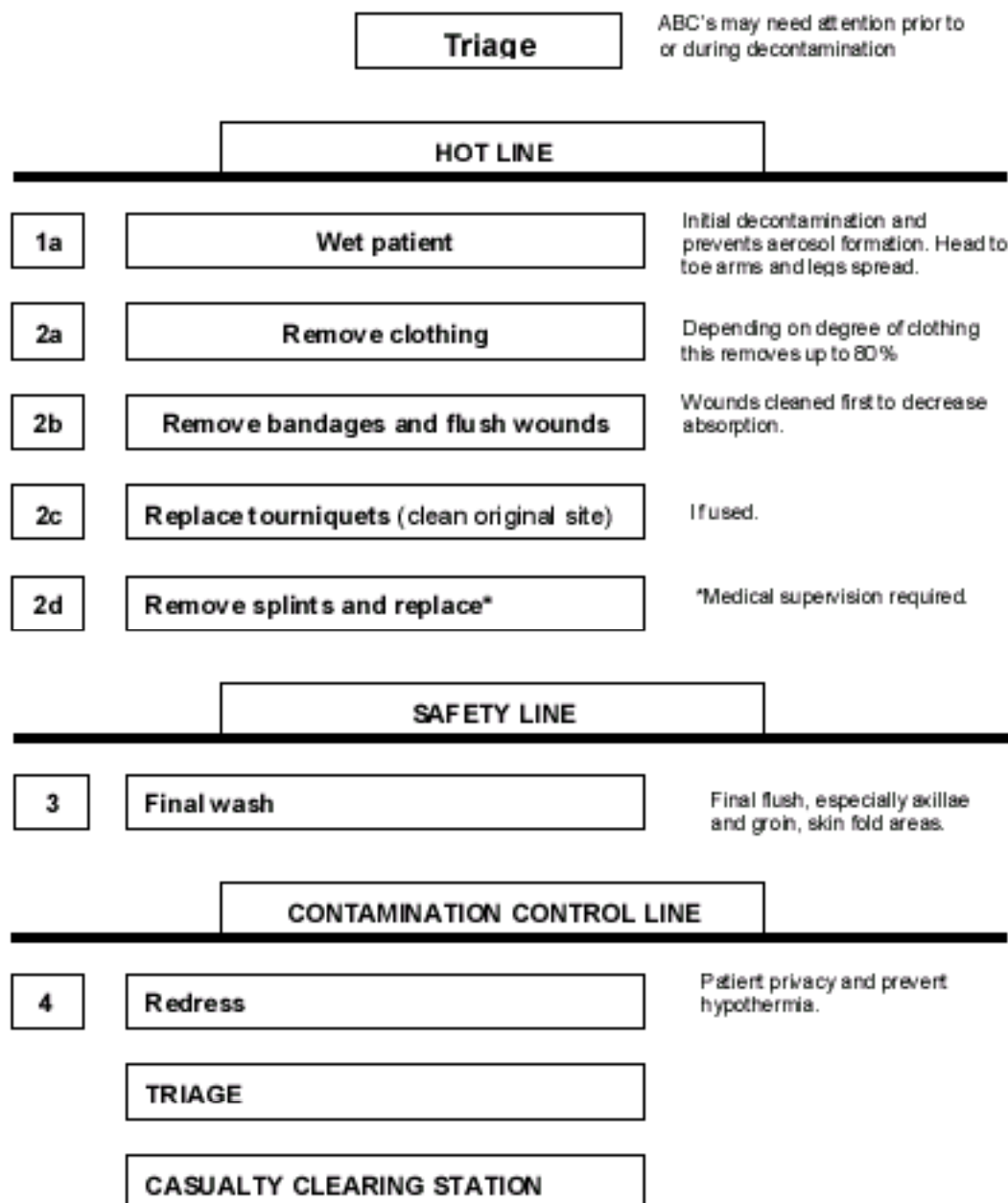

Figure 2: Personnel Decontamination Corridor



NOTES

- Occasionally, patient may need quick wash (or not) then placed in plastic bag (remember air supply) and urgent transport to hospital.
- **Water may be contraindicated** in some situations eg. elemental sodium or potassium contamination.
- The use of fullers' earth or flour to adsorb some substances may precede wetting (More information in text).
- The above assumes the responder is attired in the appropriate PPE.

Figure 3: Casualty Decontamination Corridor

PREFERRED SKIN DECONTAMINANTS

31. Desirable traits of a skin decontaminant are that it:

- neutralises all chemical and biological agents;
- is safe (non-toxic and non-corrosive);
- is applied easily by hand;
- is readily available;
- acts rapidly;
- produces no toxic end products;
- is stable in long-term storage;
- is stable in the short term (after issue to unit/individual);
- is affordable;
- does not enhance percutaneous agent absorption;
- is non-irritating;
- is hypo-allergenic; and
- is easily disposed of.

Sources: (1) Chang M. A Survey and Evaluation of Chemical Warfare Agent Contaminants and Decontamination. Dugway Proving Ground, Utah: Defense Technical Information Center; 1984. AD-202525. (2) Baker JA. COR Decontamination/Contamination Control Master Plan Users' Meeting. 11-13 September 1985. Unpublished.

AVAILABLE SUBSTANCES

32. The following substances should be available for decontamination:

- Water.
- Soap and water.
- Hypochlorite solutions.
- Isotonic bicarbonate.
- Flour plus wet tissue wipes.
- Fuller's earth or Dutch powder.

The most important issues are how and when, not, with what?

Liquids

33. Liquids are best for decontaminating large or irregular surface areas. Water and or soap and water are generally adequate. Hypochlorite solutions are well suited for decontamination corridor/CCS/hospitals with adequate water supplies, however, there are significant issues in its effectiveness and desirability for human use. It is the preferred solution for equipment.
34. Hypochlorite solutions have to be relatively fresh (made daily or more frequently, particularly in a warm environment where evaporation will occur). A concentration of 0.5 per cent at an alkaline pH (pH 10–11).

Note

Commonly used decontamination liquids and their indications and contra-indications are listed in Annex A.

CERTIFICATION OF DECONTAMINATION (MONITORING)

35. Regardless of the method used to decontaminate, certification of chemical decontamination is accomplished by the use of monitoring papers (if available). These papers are similar to those used for urinalysis ie. the indicator paper undergoes a colour change. Another device is the electronic CAM (chemical agent monitor) if available. Radiological survey meters can perform the same function in confirming reduction in the radiation hazard.
36. If proper procedure is followed, the possibility of admitting a chemically contaminated casualty to a casualty clearing station (CCS) is extremely small. The probability of admitting a dangerously contaminated casualty is minuscule to nonexistent. Fear is the worst enemy, not the contaminated casualty.
37. Evaluation of the effectiveness of the process will be demonstrated by:
 - reduced levels as personnel move through the decontamination corridor;
 - confining contamination to the hot zone and decontamination corridor; and
 - reducing of contamination to a level that is as low as reasonably achievable.
38. **The following sections deal mainly with external decontamination. Details on the management of predominantly WMD agents can be found in chapter 14 onward, whilst the reader is referred to usual sources for more common agents.**

WOUND DECONTAMINATION

General

39. Potential risk to the surgeon from contaminated wounds arises from chemical agent on foreign bodies in the wound and from thickened agents.
40. Medical personnel treating biological casualties have only a minimal risk from secondary aerosol formation of biological agents.
41. Thickened agents are chemical agents that have been mixed with another substance (commonly an acrylate) to increase their persistency. They are not dissolved as quickly in biological fluids nor are they absorbed by tissue as rapidly as other agents. VX, although not a thickened agent, is absorbed less quickly than other nerve agents and may persist in a wound longer than other nerve agents.
42. Thickened agents in wounds require more precautions. Casualties with thickened nerve agents in wounds (eg from pieces of contaminated clothing or protective garment being carried into the wound tract) are unlikely to survive to reach surgery. Thickened mustard has delayed systemic toxicity and can persist in wounds even when large fragments of cloth have been removed.
43. Although the vapour hazard to surgical personnel is extremely low, contact hazard from thickened agents does remain and should always be assumed.

Initial Decontamination

44. Initial decontamination procedures are as follows:
 - bandages are removed and the wounds are flushed.
 - bandages are replaced only if bleeding recurs.
 - Tourniquets are replaced with clean tourniquets and the sites of the original tourniquets decontaminated.
 - Splints are thoroughly decontaminated, but removed only by a medical officer.
 - The new dressings are removed in the operating room and submerged in 5 per cent hypochlorite or placed in a plastic bag and sealed.

Off-Gassing

45. The risk from vapour off-gassing from chemically contaminated fragments and cloth in wounds is very low and not significant. Further, there is no vapour release from contaminated wounds without foreign bodies. Off-gassing from a wound during surgical exploration will be negligible or zero. No eye injury will result from off-gassing from any of the chemical agents. A chemical-protective mask is not required for surgical personnel.
46. Biological agents can only be transmitted to medical personnel from secondary aerosol formation from dry agents. Decontamination with 0.5 per cent hypochlorite solution or flooding with water or saline will make this risk negligible.
47. No protective equipment is necessary for surgical personnel other than standard barrier protection, unless the patient is infected with the plague bacillus, smallpox, or a haemorrhagic fever virus, or if procedures likely to generate bloody aerosols are employed. In such cases, wearing of a filtered respirator is recommended. (HEPA)

FOREIGN MATERIAL

48. The contamination of wounds with mustard or nerve agents is basically confined to the pieces of contaminated fabric in the wound tract. The removal of this cloth from the wound effectively eliminates the hazard.
49. There is little chemical risk associated with individual fibres left in the wound. No further decontamination of the wound for unthickened chemical agent is necessary.

WOUND CONTAMINATION ASSESSMENT

50. The CAM can be used to assist in locating contaminated objects within a wound. However, 30 seconds are required to achieve a bar reading.
51. The CAM detects vapour but may not detect liquid (a thickened agent or liquid on a foreign body) deep within a wound. A single-bar reading on CAM with the inlet held a few millimetres from the wound surface indicates that a vapour hazard does not exist.
52. A radiological survey meter can be used in a similar fashion for wounds contaminated with a radioactive substance.

DILUTE HYPOCHLORITE SOLUTION

53. Dilute hypochlorite (0.5 per cent) is an effective skin decontaminant for patient use. The solution should be made fresh daily with a pH in the alkaline range (pH 10–11). Its principal use is as a liquid as the actual skin contact time is usually insufficient to neutralise the substance.
54. Dilute hypochlorite solution is contra-indicated for the eye; it may cause corneal injuries. Dilute hypochlorite solution is also not recommended for brain and spinal cord injuries.
55. Irrigation of the abdomen with hypochlorite solution may lead to adhesions and is therefore also contra-indicated. The use of hypochlorite in the thoracic cavity may be less of a problem, but the hazard is still unknown.

WOUND EXPLORATION AND DEBRIDEMENT

56. Surgeons and assistants are advised to wear a pair of well-fitting (thin) butyl rubber gloves or double latex surgical gloves and to change them often until they are certain there are no foreign bodies or thickened agents in the wound.
57. Thin butyl rubber gloves will have no breakthrough for 60 or more minutes in an aqueous base. Double latex surgical gloves are **not** generally recommended.
58. This is especially important where puncture is likely because of the presence of bone spicules or metal fragments. The wound should be explored with surgical instruments rather than with the fingers. Pieces of cloth and associated debris must not be examined closely but quickly disposed of in a container of 5 per cent hypochlorite.
59. The wound can then be checked with the CAM, which may direct the surgeon to further retained material. It takes about 30 seconds to get a stable reading from the CAM. A rapid pass over the wound will not detect remaining contamination.
60. The wound should be debrided and excised as usual, maintaining a no-touch technique. Removed fragments of tissue should be dropped into a container of 5 per cent to 10 per cent hypochlorite. Bulky tissue such as an amputated limb should be placed in a plastic or rubber bag (chemical proof), which is then sealed.
61. Dilute hypochlorite solution (0.5 per cent) may be instilled into deep, non-cavity wounds following the removal of contaminated cloth. However, water or saline are preferred.
62. This hypochlorite solution should be removed by suction to a disposable container. Within a short time (ie, 5 min), this contaminated solution will be neutralised and rendered non-hazardous. Subsequent irrigation with saline or other surgical solutions should be performed.

63. Penetrating abdominal wounds caused by large fragments or containing large pieces of chemically contaminated cloth will be uncommon. Surgical practices should be effective in the majority of wounds for identifying and removing the focus of remaining agent within the peritoneum. When possible, the CAM may be used to assist.
64. Saline, hydrogen peroxide, or other irrigating solutions do not necessarily decontaminate agents but may dislodge material for recovery by aspiration with a large-bore suction tip. The irrigation solution should not be swabbed out manually with surgical sponges. Although the risk to patients and medical attendants is minuscule, safe practice suggests that any irrigation solution should be considered potentially contaminated.
65. Following aspiration by suction, the suction apparatus and the solution should be decontaminated in a solution of 5 per cent hypochlorite. Superficial wounds should be subjected to thorough wiping with 0.5 per cent hypochlorite and subsequent irrigation with normal saline or sterile water.
66. Surgical and other instruments that have come into contact with possible contamination should be placed in 5 per cent hypochlorite for 10 minutes prior to normal cleansing and sterilisation.
67. Re-usable linen should be checked with the CAM, or test tape for contamination. If found to be contaminated, the linen should be soaked in a 5 per cent to 10 per cent hypochlorite solution. Disposable linen is also an option, however, it then poses a disposal problem.

CHEMICAL DECONTAMINATION

Nerve Agents

68. The importance of early decontamination can not be over emphasised. Decontamination of the skin should be accomplished quickly if it is to be fully effective. Liquid agent may be removed by fullers' earth or chemically inactivated by the use of reactive decontaminants.
69. Decontamination personnel should use a respirator and full protective equipment whilst decontamination is performed. Once a casualty has been decontaminated, or the agent fully adsorbed, no further risk of contamination exists. The casualty's body fluids, urine or faeces do not present a hazard.

Vesicants

70. **Mustard**—Exposure to mustard is not always noticed immediately because of the latent and sign-free period that may occur after skin exposure. This may result in delayed decontamination or failure to decontaminate at all. Immediate action should be taken as follows:
 - *Decontamination of Mucous Membranes and Eyes*—The substances used for skin decontamination are generally too strongly irritant to be used on mucous membranes and the eyes. In this case the affected tissues should

be flushed immediately with water from the water bottle (canteen). The eyes can be flushed with copious amounts of water, or, if available, isotonic sodium bicarbonate (1.26 per cent) or saline (0.9 per cent).

- *Decontamination of the Skin*—Rescue workers should be considered for supply of their own personal means for a preliminary decontamination of the skin, the means being based on physical adsorption or on the combination of physical adsorption and chemical inactivation. Physical adsorption can be achieved by adsorbing powders. Chemical inactivation is often effected by chlorinating compounds incorporated into adsorbing powders, ointments, solutions or organic solvents. Mustards should not be decontaminated with water, except for the eyes, as this may spread the agent.
 - *Efficiency and Speed*—Whatever means is used it has to be efficient and quick-acting. Within two minutes contact time a drop of mustard on the skin can cause significant damage. Chemical inactivation using chlorination is effective against mustard and Lewisite, less so against nitrogen mustard, and is ineffective against phosgene oxime. In the case of thickened mustard, or thickened nerve agent where the usual procedure is inadequate, the decontamination mitt should be used. This involves padding and mopping (no rubbing). This may be followed by cleaning the surface with a detergent specifically designed for NBC agents. Water and soap washing is contraindicated as it may spread the agent.
 - *Decontamination of Wounds*—Mustard may be carried into wounds on fragments of cloth. These wounds should be carefully explored using a no-touch technique. Fragments of cloth should be removed and placed in a bleach solution. This removes the hazard from mustard vapour off-gassing. Wounds should be irrigated using a solution containing 3000–5000 ppm free chlorine (dilute ‘milton’ solution see section on preparation of chlorine solutions) with a dwell time of approximately two minutes. The wound should then be irrigated with saline. Irrigation of the contaminated wound should not be used in the abdominal, or thoracic cavities, nor with intracranial head injuries. Hydrogen peroxide may be used but is not as effective as Milton’s solution.
- 71. Phosgene Oxime**—Chemical inactivation using alkalis is effective, whereas chlorination is ineffective against phosgene oxime. The eyes should be flushed immediately using water or isotonic sodium bicarbonate solution if available. Physical decontamination of the skin using adsorbent powders eg fullers’ earth is advised.
- 72. Blood Agents**—Because of their physico-chemical properties the agents will not remain for long in their liquid state. Decontamination should not, therefore, be necessary.
- 73. Oedemagens**—Because of their physico-chemical properties, the agents will not remain in their liquid form for long, and decontamination is not required except when it is used in very cold climates.

- 74. *Incapacitants***—Complete cleansing of the skin with soap and water should be accomplished at the earliest opportunity. Symptoms may appear as late as 36 hours after percutaneous exposure, even if the skin is washed within an hour. In fact, a delay in onset of several hours is typical. This time should be used to prepare for the possibility of an epidemic outbreak 6 to 24 hours after the attack.

BIOLOGICAL AGENT DECONTAMINATION

Primary Contamination

- 75.** A biological incident may be very difficult to detect unless announced. Once detected, dermal exposure from a suspected biological incident should be managed by decontamination at the earliest opportunity. In the absence of agent-specific guidance, exposed areas should be cleansed using an appropriately diluted sodium hypochlorite solution (0.5 per cent) or copious quantities of plain soap and water.
- 76.** This should follow any needed use of decontaminants for chemical agents, but should be prompt. Potentially contaminated clothing should be removed as soon as is practical by protected personnel (that is, in personal protective equipment) in an area away from non-contaminated patients. Following decontamination, the casualty should be protected from further exposure if transported or cared for outside a collective protection (Colpro) system.

Secondary Contamination

- 77.** Secondary contamination of health personnel from clothing or equipment of exposed casualties may be important. This is a particular problem from casualties recently exposed near the dissemination source, where high levels of contamination may occur. Since it will be difficult to distinguish those casualties exposed near the source from those contaminated some distance away, proper physical protection of health care providers or other persons handling exposed personnel should be maintained until decontamination is complete.
- 78.** Unprotected staff and equipment used to manage biological incident casualties must be decontaminated.

Susceptibility of Agents

- 79.** Biological agents have the same susceptibility to modern disinfectants as naturally occurring micro-organisms. In static health care facilities disinfectants should be used liberally on floors and work surfaces. Health personnel should use a disinfectant bucket when discarding contaminated material (dressing, swabs, syringes, etc).

General Points

- 80.** Decontamination of personnel and equipment after a biological attack is a lesser concern than after a chemical attack because most biological agents are

not dermally active. (The trichothecene mycotoxins are an exception.) Still, decontamination remains an effective way to decrease the spread of infection from potential secondary aerosols

81. For biological agents, contamination is defined as the introduction of micro-organisms onto tissues or sterile materials, whereas decontamination is defined as disinfection or sterilisation of infected articles to make them suitable for use (the reduction of micro-organisms to an acceptable level).
82. Disinfection is defined as the selective elimination of certain undesirable micro-organisms to prevent their transmission (the reduction of the number of infectious organisms below the level necessary to cause infection), and sterilisation is defined as the complete killing of all organisms. Biological agents can be decontaminated by chemical and physical methods.

Chemical Method

83. Chemical decontamination renders biological agents harmless by the use of disinfectants. The recommended method for chemical decontamination is as follows:
 - Dermal exposure to a suspected biological agent should be immediately treated by soap and water decontamination.
 - Careful washing with soap and water removes a very large amount of the agent population from the surface.
 - It is important to use a brush (soft bristle) or sponge to ensure mechanical loosening from the skin surface structures, and then to rinse with copious amounts of water.
 - The contaminated areas should then be washed with a 0.5 per cent hypochlorite solution, if available, with a contact time of 10 to 15 minutes. The solution should be applied with a cloth or swab or can be sprayed on.
 - As with hypochlorite in chemical decontamination, this solution should not be used in the eyes, abdominal or thoracic cavities, or on neural tissue.
 - It will neutralise and render non-hazardous any biological agent within approximately five minutes.
 - For decontamination of clothing or equipment, a five per cent hypochlorite solution should be used.
 - For decontamination of equipment, a contact time of 30 minutes prior to normal cleaning is required.
 - Use of hypochlorite solution in this way is corrosive to most metals and injurious to most fabrics, so they should be rinsed thoroughly and metal surfaces should be oiled after completion.
 - An important point to remember is that soap and water washing followed by hypochlorite washing to decontaminate for biological agents should be

prompt but should follow any needed use of decontaminants for chemical agents.

- Ampoules of calcium hypochlorite granules may be fielded in a chemical agent decontamination kit for mixing hypochlorite solutions. The 0.5 per cent solution can be made by referring to Annex D.
- The five per cent solution can be made by referring to Annex D.
- These solutions evaporate quickly at high temperatures, so if they are made in advance, they should be stored in closed containers.
- The hypochlorite solutions should be placed in distinctly marked containers because it is very difficult to distinguish visually a 0.5 per cent solution from a five per cent solution.

Physical Method

84. Physical methods are concerned with rendering biological agents harmless through such physical means as heat and radiation as follows:

- **Heat**—To render agents completely harmless, dry heat requires two hours of treatment at 160°C. If steam is used at 121°C and 103kPa of overpressure (15 psi), the time may be reduced to 15 minutes, depending on volume (auto-claving—refer to Australian Standards).
- **Radiation**—The part of solar ultraviolet radiation that reaches the Earth's surface has a certain disinfectant effect, often in combination with drying. Ultraviolet radiation is effective but hard to standardise into practical usage for disinfection or decontamination purposes.

SUMMARY OF CHEMICAL AND BIOLOGICAL APPROACHES

Chemical

85. Decontamination at the casualty clearing station is directed toward:

- eliminating any chemical agent transferred to the patient during removal of protective clothing;
- decontamination or containment of contaminated clothing and personal equipment; and
- maintaining an uncontaminated transfer area.

Biological

86. Current doctrine specifies the use of 0.5 per cent hypochlorite solution for chemical or biological skin contamination. Fabric and other foreign bodies that have been introduced into a wound can sequester and slowly release chemical agent, presenting a liquid hazard to both the patient and medical personnel.
87. Dry biological agent could be a hazard through secondary aerosols. Adequate liquid decontamination will mitigate this hazard. There is no vapour hazard, and protective masks are not necessary for surgical personnel.

RADIOLOGICAL DECONTAMINATION

General

88. Although less frequent than other chemical and biological incidents we are fortunate in that, instruments are available for the type and intensity of radiation present and end points can be measured.

Exposure History

89. History should include type (eg internal, inhalational, wound contamination, external and/or irradiation).

Note

A casualty that has been irradiated requires no decontamination and is not a threat to rescuer. Shielding and distance from and time in proximity to the source of the radiation should still be monitored.

Specific Field Detection Equipment

90. There are three different meters used in field detection:
 - **Geiger-Muller Survey Meter**—This instrument:
 - detects both beta and gamma-emitting materials;
 - does not detect neutrons or alpha particles; and
 - requires spare batteries.
 - **Alpha Meter**—This instrument:
 - is sensitive;
 - is delicate;
 - needs a radiation physicist (due to probes); and
 - requires spare probes.
 - **Dosimeter**—This is a personal device. There are three types:

- Thermoluminescent dosimeter (TLD).
- Film badge.
- Electrostatic pen dosimeter.

91. Always consult radiation physicist, for advice.

92. All members of a decontamination team need a personal dosimeter. Radiation caution signs and labels (magenta and yellow trefoil sign) should be carried by all decontamination team.

RADIATION DECONTAMINATION PLAN

93. This is similar to the plans mentioned earlier except the risk to the responder is related to distance from, time in contact with and the dose. Therefore additional precautions are as follows:

- Respiratory protection (which may include level A protection for grossly contaminated areas, but as a minimum, a respirator is required).
- Protective clothing disposal and resupply.
- Body washing and associated considerations should include:
 - all orifices (eg external auditory canal);
 - use of heated water and soap (usually adequate);
 - hair clipping;
 - contact lenses; and
 - control of run-off.
- Medical evaluation should include:
 - all victims;
 - all rescue personnel who entered the **hot** zone;
 - logging of all personnel;
 - noting of all open wounds or skin breaks (irrespective of age); and
 - all cleansed wounds for the presence of contaminants.
- Consult specialists in field regarding wound management.
- The following points regarding observation, medical treatment, and debriefing should be noted:
 - Special decontamination procedures may be required for some, with inhalation of substance (eg hyperbaric), wound decontamination

(surgical debridement) or substances that readily penetrate intact skin.

- Observation may be needed for chemicals with delayed effects.
- Note for **all** personnel, the duration of exposure, the protection used, and any special features of the incident.

RADIATION DECONTAMINATION PROCEDURES

Unbroken Skin

94. Procedures for radiation decontamination of a patient with unbroken skin are as follows:

- Undress the patient. (This will often eliminate 90 per cent of contaminants).
- Bag and tag clothing with the patient's name.
- Package wallet and personal effects separately.
- Identify areas to be decontaminated using the appropriate monitoring equipment.
- Use front and back charts.
- Seek out any breaks in the skin and areas with the highest levels of contamination.
- Mark such areas with lipstick or felt-tip marker.
- Hair-covered areas may be clipped but should not be shaved.
- Isolate areas of contamination with plastic sheets and tape to cover uncontaminated areas.
- Mobile patients may shower using surgical soap and water.
- Comatose and severely injured patients should be showered with hoses equipped with mist nozzles.
- With patients who are unable to shower, an attendant should wash off contamination with surgical soap and moistened sponges.
- Schubert's solution, which can be used if available to assist decontamination, consists of the following ingredients:

Citric acid	4.2 g/l
Tartaric acid	3.0 g/l
Disodiumethylene diaminetetraacetic acid (EDTA)	8.0 g/l
Calcium chloride	2.2 g/l
Adjust solution to pH 7.0 with concentrated sodium hydroxide.	

- On completion of the above, re-survey the patient. If necessary repeat the procedure and re-survey.
- If this fails, scrub the area gently with a concentrated solution of equal parts of soap detergent, water and cornmeal (this is often known as decontamination solution E).
- If there is a substantial amount of contamination persisting after this scrub, household strength chlorine bleach may be used as a scrub solution.
- Repeat the scrub until contamination is completely removed, or three scrubs fail to decrease the decontamination appreciably.
- At this point, the decontamination officer should consult with both a physician and a radiation physicist to determine the allowable contamination.
- The patient's current contamination level should be re-surveyed, and a joint decision about surgical debridement or more vigorous skin debridement should be made.

Broken Skin and Incorporation

95. Procedures for radiation decontamination of a patient with broken skin and incorporation are as follows:

- Incorporation of radioactive material via a wound site, inhalation, or ingestion is a medical emergency that must be managed in the pre-hospital environment.
- Internal tissues can become permanently irradiated.
- In addition, the material may become incorporated into the normal biochemical processes of the body.
- Survey and mark the wounds as noted above. Irrigate wounds and broken skin with copious amounts of water for 5 to 10 minutes.
- Ensure that no contamination is washed into eyes, mucous membranes, or wounds.
- Carefully decontaminate intact skin surrounding the wounds as noted above.
- Do not flush the wound with chelating agents or other decontamination solutions.
- Resurvey the wound.
- Continue irrigation with water or saline until the radioactivity is either undetectable or within acceptable limits.
- If the radioactivity persists have a health physicist calculate the expected body burden from the residual contamination.
- The health physicist and a surgeon or emergency physician jointly, should determine the feasibility of sharp debridement of the area.

- Anaesthesia should be given by a regional block through uncontaminated skin wherever possible.
- If possible tissue dissection is done to preserve tissue margins. The wound should be surveyed after the dissection. The specimen should be treated as radioactive waste.

Eyes

96. Procedures for radiation decontamination of a patient's eyes are as follows:

- In all cases, irrigate the eyes with copious amounts of water or normal saline.
- Direct the irrigation from the nose to the temples so that contamination is washed away from the nasal tear drainage.
- Survey the area frequently.
- Check nasal washings and swabs for residual contamination.

Nose and Mouth

97. Procedures for radiation decontamination of a patient's nose and mouth are as follows:

- Ensure that the contamination is truly in the cavity and not the surrounding area.
- Instruct the patient not to swallow.
- If possible irrigate the mouth and nasal areas with copious amounts of water and gently swab with cotton applicators.
- Frequent suctioning will help the patient avoid swallowing secretions.

Ingested Radioactive Materials

98. Procedures for radiation decontamination of a patient who has ingested radioactive materials are as follows:

- These should be removed by, inducing emesis if at all possible. Emesis may be induced by usual doses of ipecac.
- If the patient is unconscious then lavage may be necessary.
- Providers faced with this situation should consult a nuclear medicine physician or radiation medicine specialist.
- There are no data that activated charcoal is useful for binding radioactive materials.
- Whole gut lavage can be used to decrease residence time of radioactive materials in the gastrointestinal tract.
- This solution can be easily monitored for radioactivity.
- Aluminium-containing antacids can significantly reduce the absorption of radioactive strontium and a dose of 85 grams should be given.

- Barium sulphate can prevent the absorption of radium and strontium by formation of insoluble sulphates.

Pharmacologic Therapy For Radioisotope Absorption

99. Pharmacologic therapy includes the following:

- Investigational drug diethylenetriamine pentaacetic acid (DTPA).
- Calcium disodium CaNa₂EDTA (calcium yersenate).
- CaDTPA.
- ZnDTPA.
- Desferrioxamine LICAM(C).
- Iodine.

Further information on the action of the above substances can be found in Chapter 16.

DECONTAMINATION OF BIOHAZARD EXPOSURE

100. Problems in decontaminating injured patients in any environment are as follows:

- Detection of vital signs may range from difficult, to impossible, when either the examiner or casualty is wearing protective garments.
- Adequate monitoring of the patient's condition may require the protective garments to be breached.
- It is unlikely that there will be enough pulse oximeters on hand.
- Oxygenation may also pose a problem.

Annexes:

- A. Common Decontamination Solutions
- B. General Decontamination Equipment
- C. Radioactive Decontamination Equipment
- D. Chlorine Solutions for Disinfection

COMMON DECONTAMINATION SOLUTIONS

Decontamination Solution A

Decontamination Solution A contains 5 per cent sodium bicarbonate and 5 per cent trisodium phosphate.

Decontamination Solution A may be used on intact skin, followed by copious water irrigation. Solution A is not to be used on open wounds, mucous membranes, or eyes. Generally these areas are best treated with copious irrigation by large volumes of low- pressure water for extended periods.

Decontamination Solution A may be used for:

- inorganic acids;
- acidic caustic wastes;
- metal processing wastes;
- solvents and organic compounds;
- plastic wastes and PCBs (polychlorinated biphenols); and
- biological contamination.

Decontamination Solution B

Decontamination Solution B is a concentrated solution (10 per cent) of bleach. Anhydrous calcium hypochlorite powder is commonly known as HTH and is available from swimming pool shops.

Decontamination Solution B may be used on intact skin after it is diluted 50:50 with water to form a 5 per cent solution (similar to household bleach). Regular strength 5 per cent household bleach containing sodium hypochlorite can be substituted for Solution B. Use of either solution should be followed with copious irrigation with water. Solution B is not to be used on open wounds, mucous membranes, or eyes.

NB: Only use 5 per cent if large volumes of water are available.

Decontamination Solution B may be used for:

- radioactive materials (especially plutonium);
- heavy metals such as lead, mercury, or cadmium;
- pesticides, chlorinated phenols, dioxin, and PCBs;
- cyanide;
- ammonia;
- inorganic wastes;

- organic wastes; and
- biologic contamination.

Decontamination Solution C (Rinse Solution)

A general purpose rinse solution of 5 per cent solution of trisodium phosphate, suitable for use with chemical decontamination Solutions A and B.

Rinse solution is an effective decontaminant for:

- solvents and organic compounds;
- polychlorinated Biphenols (PCB) and Polybrominated Biphenyls (PBB); and
- oily wastes not suspected to be contaminated with pesticides.

Solution C is not to be used on open wounds, mucous membranes, or eyes.

Following a rinse with Solution C the equipment may be rinsed with water.

Decontamination Solution C may be used on intact skin and should be flushed off with water.

Decontamination Solution D (Alkali Decontamination Solution)

Decontamination solutions listed above are not effective with strong alkali contaminating agents. This is a dilute solution of hydrochloric acid. This solution is used to decontaminate **equipment only** and should not be used on personnel.

Decontamination Solution D is suitable for:

- inorganic bases;
- alkalies; and
- alkali caustic wastes.

All skin, eye, or mucous membrane exposed to any of these alkali agents should be treated by copious irrigation with water.

GENERAL DECONTAMINATION EQUIPMENT

Containment Equipment:

- Decontamination stretchers/work surfaces with drainage collection tanks.
- Generous work space.
- Adjoining space for monitoring of workers leaving or re-entering area.
- Location away from general traffic.
- Plastic wading pools.
- Water supply. (Note volume, temperature and delivery).
- Spray/wetting devices. (Note showers and or hand held).
- Decontamination solutions.
- Sterile irrigation fluid eg normal saline or water.
- Irrigation syringes (20 and 50 ml with splash guards if available).
- Irrigation basins and bowls.
- Larger self-contained decontamination units.
- Plastic containers with lids.
- Plastic sheeting to contain spills and provide privacy for casualties/ responders.
- Plastic bags (+stickers to label bags) All sizes large numbers.
- Plastic sheeting to line floors and walls of access corridors to emergency department (ED).
- Plastic sheeting to line work areas in ED.
- Plastic sheeting to cover non-essential and non-movable equipment.
- Plastic sheeting or filter paper and engineer's or gaffer tape to seal ventilation ducts.
- Signs to indicate 'Safe' and 'Dirty' corridors.
- Engineer's tape to mark out exclusion zones and decontamination stations. (Special purpose marker tape is somewhat more expensive).
- Marker cones.
- Absorbent Material (available from commercial supply houses, check with fire service). Allows for spills to be absorbed and then cleaned up easily eg kitty litter.

- Sponges and soft brushes.
- Disposable Suture Sets for removal of particulate matter.
- Personal protective clothing depending on incident and local selection, remembering face, body, hands and feet.
- Respirators (often will include face protection).

Miscellaneous Equipment

- Cotton swabs.
- Blood collection equipment.
- Urine collection containers.
- Sputum collection containers.
- Triage tags.
- Labels for patients and bags.
- Patient record (paper/card).
- String or rubber bands.
- Clipboard and paper for keeping track of patients.
- Log book.
- Indelible markers.
- Large plastic bags (clear/white/yellow).
- Absorbent gauze.

RADIOACTIVE DECONTAMINATION EQUIPMENT

- Radiation detection instruments (eg gamma-beta monitor, dosimeters or film badges, dosimeter chargers and extra batteries).
- Body chart survey diagrams (for coding contaminated areas).
- Protective clothing (multiple sets) eg surgical scrubs, surgical gowns, caps and masks, shoe covers and latex or rubber gloves.
- Tape for sleeves.
- Portable shielding if gamma radiation involved.
- Protective eye-wear with side shields.
- Neoprene industrial gloves, for site clean up.
- Tongs and forceps for remote handling.
- Instruction cards for decontamination.
- **All biological fluids** (eg blood, urine, faeces, vomitus and wipes from nose, ears, eyes, skin and nails) should be regarded as contaminated. They should be stored in containers for clearance by the RSO.
- Decontamination stretcher(s) or disposable litters.
- Large waste containers (plastic garbage containers) with plastic liners.
- Clorox and bleach solutions.
- Abrasive soap.
- Razor blades and scissors to trim hair etc.
- Nail clippers.
- Wipes and sponges.
- Suture sets for wound debridement.
- Biologic sampling equipment with vials and swabs.
- Lead storage containers to contain samples.
- Radiation signs.
- Yellow rope with stands for demarcation of areas.
- Plastic (polyethylene 2 x 10 m x 150 microns) floor and wall covering.
- Plastic (polyethylene 1 x 10 m x 150 microns) covering for corridors and halls.

- Garden hose or other delivery mechanism and extensions with a variable spray head for low pressure washes.
- Large yellow (bio-hazard) plastic bags with ties.
- 50 mm engineers or gaffer tape.
- Self-adherent contamination labels.
- 'Radioactive' labelled tape.
- Notebook with pencils.
- Indelible markers.
- Towels, sheets, and wash clothes (multiple sets).
- Washbasins.
- Gauze 100 X 100 mm and 50 x 50 mm.
- Bandages.
- Plastic drapes.
- Kitty litter for adsorbent.

CHLORINE SOLUTIONS FOR DISINFECTION

Use concentrated chlorine with four per cent available chlorine (bleach).

Select the concentration required as a percentage or ppm then dilute that amount of concentrated chlorine in water to make up the required volume (eg for 10 litres of a 0.05 per cent solution 125 mls of four per cent available chlorine is diluted in 9875 mls of water).

Concentration%	02%	.05%	1.0%	5.0%
Concentration ppm	200	500	10,000	50,000
Total made up volume				
5 litres	25mls	62.5mls	1250mls	n/a
10 litres	50mls	125mls	250mls	n/a
50 litres	250mls	625mls	1250mls	n/a

Notes

- (a) New batches are required frequently especially if left open to atmosphere.
- (b) Chlorine releasing granules are preferred to liquid hypochlorite disinfectant for dilution as hypochlorite solution loses concentration during storage.
- (c) You should wear gloves when handling and preparing chlorine solutions.
- (d) Sodium hypochlorites are corrosive to metals other than stainless steel at concentrations of 1000 ppm.

NB: Ideally pharmacy or an external supply house could prepare sealed bottles of pre-measured granulated chlorine to be dissolved in a specified volume of water to create the required concentration.

CHAPTER 7

DETECTION

CBR WARNING AND REPORTING

1. Adequate and accurate intelligence is required in order to develop an effective defence against biological and chemical weapons. Once an agent has been dispersed, detection of the aerosol prior to its arrival over the target, in time for personnel to don protective equipment, is the best way to minimise or prevent casualties. In the absence of prior warning, detectors collocated with personnel constitute the only means of detecting biological and chemical agent attacks before symptoms occur among victims.

RADIATION

2. Equipment exists for monitoring, once the incident type has been identified.

BIOLOGICAL

3. The pattern of occurrence of illness resulting from a biological agent attack is entirely different from a naturally occurring illness (see Chapter 19). Such patterns may be expressed mathematically and detected by computer after appropriate data processing.
4. Public health units provide routine information on notifiable illnesses. This data is fed to a central facility for analysis. This system will be in operation for a biological incident.

Biological Agent Detection Devices

5. Theoretically, there are several methods by which organic matter may be detected in the soil and in air, including devices based upon gas chromatography, labelled gas exchange systems and chemiluminescence. Such systems have been used successfully in the Antarctic and on the planet Mars. The main problem, in the biological operations context, is to differentiate the biological agent from the normal background of organic matter.

Biological Integrated Detection Systems

6. These systems are under development to detect the presence of biological agents dispersed as aerosols. They will incorporate air samplers, particle sizers, chemoluminescence and rapid antibody detection systems.
7. Such detector systems are evolving, and represent an area of intense interest within the research and development community. The principal difficulty in detecting biological agent aerosols stems from differentiating the artificially generated biological weapon cloud from the background of organic matter normally present in the atmosphere.

CHEMICAL

Nerve Agent Detection

8. Nerve agents may be detected by a variety of means:
 - Single and three colour detector papers are available for individual issue to detect liquid nerve agent.
 - Chemical agent monitors (CAMs) are available for area detection and monitoring local contamination.
 - Residual vapour detectors and water testing kits are also available.

Vesicant Detection

9. Vesicants may be detected as follows:
 - **Mustard**—This agent has the interesting property of forming, under certain conditions, coloured complexes with para-nitrobenzpyridine thus making it possible to detect minute amounts. Mustard agents can be detected by a variety of means. Single and three colour detector papers will detect liquid agent and are available for individual issue. Monitoring devices for local contamination and water testing kits are also available.
 - **Lewisite**—The detection of this agent is facilitated by the fact that it forms coloured products with many reagents. Draeger tubes are available which react with organic arsenicals. However, no automatic detectors are available for use in the field.
 - **Phosgene Oxime**—The characteristic signs and symptoms of phosgene oxime exposure may suggest its use. There are no automatic detectors available for use in the field.

Oedemagens Detection

10. There are no automatic detectors available for use in the field.

Cyanide Agent Detection

11. Automatic detectors are available which detect weapons concentrations of cyanide vapour. Draeger tubes are also available, as are water-testing kits.

LABORATORY SERVICES

Sample Collection

12. The accurate reporting of clinical findings may be critical in alerting other units to both the possibility and nature of a biological incident. Unfortunately, attempts to reach a firm diagnosis on clinical grounds alone may not be productive. Emerging technology will likely provide provisional diagnostic

capabilities locally. However, establishing a definitive diagnosis will often require specialised laboratory facilities.

13. General policies for collecting samples in order to facilitate identification of biological agents are essential. Health responsibilities normally are limited to collection and submission of diagnostic materials from patients. Environmental sampling is an important element in corroborating the occurrence of a biological incident, but is the responsibility of other agencies.
14. Success or failure in providing a timely health response will depend upon the rapidity and accuracy of the diagnostic effort, together with the transmission of timely information from those organisations involved in environmental sampling.
15. General principles of the collection and processing of medical samples are as follows:
 - ***Specimen Collection:***
 - Blood culture with routine media will readily detect many bacterial agents, although specialised media may be required for some. Both aerobic and anaerobic cultures should be obtained routinely. Cultures and impression smears should be taken from involved lymph nodes, sputum, pleural fluid, CSF, and spleen when possible.
 - Acute serum (at least 3ml for suspected infectious agents, and at least 20ml serum for suspected intoxications) should be collected as early as possible after onset of symptoms and shipped in ice from the field or through routine mechanisms within hospitals to the appropriate laboratory. The laboratory will forward specimens to reference units if required. It is important that blood samples are placed in the correct type of tube to permit analysis. The type of tube and transport requirements should be included in health plans in consultation with local laboratories.
 - Blood samples also should be obtained from exposed persons who are not yet symptomatic. Convalescent sera from survivors and non-affected unit members should be obtained 3–4 weeks later.
 - Samples for isolation of suspected viral agents should be obtained from organs and tissues as described above, and placed in specialised transport media and managed as above.
 - Tissue samples obtained at surgery/autopsy should be collected in multiple aliquots: Minimally, one (25–50 gms) to freeze for microbiology or toxicology and one in formalin for histopathology should be obtained. Where possible, additional specimens for specialised procedures such as immunofluorescence or polymerase chain reaction (PCR) studies should be obtained.
 - Organs sampled should include lung, mediastinal lymph nodes, spleen, and liver. Obvious lesions and adjacent normal tissue should

be taken from affected areas in any organ. Post mortem blood (up to 20 ml) should be obtained and submitted as serum and clot or cells.

- ***Specimen Labelling:***
 - Each container should be labelled with name, numerical identities, type of specimen, and date of collection. Included should be a brief description of the illness and gross autopsy findings; place, date, and time of death; place, date, and time of collection; pathologists; and unit. Samples for microbiological or toxicological analysis should be kept as cold as possible, preferably frozen. Formalin-fixed material must not be frozen.
 - All serum samples should be completely labelled with patient's name, numerical identifier, unit, date, originating health facility, and health facility to receive results (if different from submitting facility). Routine laboratory slips should be included with each sample. Data on laboratory slips should include number of days since onset of symptoms and the reason that samples were obtained.
 - Clinical and operational data should be included for all samples, together with a form to establish chain of custody. This requirement must be strongly and clearly delineated, since evidence may well be politically or militarily disputed.
- ***Specimen Handling and Shipment:***
 - All specimens from suspected biological incident casualties should be submitted through the routine diagnostic laboratory chain for processing. Samples must be clearly marked for special diagnostic testing, and chain-of-custody procedures maintained.
 - Serum should be contained in plastic screw-cap vials/vacuum containers (as determined locally), which are securely sealed. If possible, each serum sample should be individually placed in a plastic zip-lock bag to prevent leakage. All specimens should be contained in a metal shipping can or other secondary container. Sufficient absorbent material should be packed to prevent leakage outside the container. The entire contents should be placed in an insulated shipping container with cold packs or dry ice.
 - It is the responsibility of the laboratory officer, in concert with the Physician, to ensure that suspect specimens are submitted correctly and expeditiously to an appropriate diagnostic laboratory.

Methods of Identification of BW Agents

16. Methods of identification of BW agents include:

- isolation of the aetiological agent by culture (possible in one to two days for some agents);

- detection of toxin by mass spectroscopy, animal inoculation, or other methods;
- antibody detection (specific IgM may appear within 3 days);
- antigen detection via enzyme immunoassay or other sensitive assay methods;
- genome detection employing DNA probes; and
- detection of metabolic products of the infectious or toxic agent in clinical specimens.

Environmental Samples

17. The procedures to be carried out with environmental samples are as follows:

- wear personal protection;
- place any appropriate samples (collected distillate, free liquid, parts of clothing which have been contaminated with agent) in glass jars;
- double seal in plastic bags;
- label with place, date and time; and
- store under refrigeration.

CHAPTER 8

DISSEMINATION

INTRODUCTION

1. Although chemical and biological agents are highly toxic, their full offensive capability can only be realised if they can be effectively dispersed. This is achieved by breaking down the bulk agent into tiny particles and vapour.
2. Coupled with the above is the effect of weather and terrain on dissemination (see paragraph 6 onwards).

Effective Particle Size

3. For rapid effects from surprise attack, agents must be presented in the respirable size range (0.1–10 microns) so that inhalation and retention in the lung may occur.

CHEMICAL AGENT TECHNIQUES

4. There are a number of techniques for disseminating chemical agents which break down the bulk agents into tiny particles. These are detailed below.

Aircraft Spray

5. Aircraft spray is produced by forcing liquid through a spray head under pressure. The particles usually 100–400 microns, are large enough to reach the ground without being evaporated or blown away.

Aerosol Devices

6. Respirable aerosols may be produced from high pressure atomisers. Generation rates are only a few grams per second which may be practical for a covert system. Other techniques for aerosol production include the use of pyrotechnic devices and jet engines. Pyrotechnic devices eventually vaporise the chemical which will condense into an aerosol of respirable size on cooling. Chemicals can also be aerosolised by injecting them into the high velocity exhaust stream of a jet engine.

Droplet Production

7. Droplets may be produced from an exploding shell or by base ejection into the slip stream of the shell. A side range of drop sizes are produced as this is usually effective only in an on-target attack. A variation of this is the use of missiles which may vent agents. Droplet sizes may be

modified by the use of thickening agents. Some more persistent agents (eg VX) could remain a contact hazard for prolonged periods.

Other Techniques

8. These include the use of agent to contaminate food and water. VX and mustard may persist in water for some time.

BIOLOGICAL AGENT TECHNIQUES

9. The same routes of entry pertinent to natural spread of diseases (ie, through inhalation, ingestion, or percutaneous inoculation) are also relevant when their etiologic agents are delivered intentionally by weapons. Biological agents are most likely to be delivered covertly and by aerosol. Other routes of entry are thought to be less important than inhalation but are, nonetheless, potentially significant. The main methods are described below.

Aerosol

10. Aerosol techniques are as follows:

- **Respiratory Exposure (Inhalation)**—Inhalation of agent aerosols, with resultant deposition of infectious or toxic particles within alveoli, provides a direct pathway to the systemic circulation. The natural process of breathing causes a continuing influx of biological agent to exposed individuals. The major risk is pulmonary retention of inhaled particles. Droplets as large as 20 microns diameter can infect the upper respiratory tract; however, these relatively large particles are generally filtered by natural anatomic and physiological processes, and only much smaller particles, ranging from 0.5–5 microns, reach the alveoli efficiently. Still smaller droplets are inhaled, but they are not efficiently retained in humans. Aerosol delivery systems aim to generate invisible clouds with particles or droplets between 0.5 and 10 microns in diameter, which can remain suspended for long periods. Smaller sized particles are not efficiently retained by the human respiratory tract, and are relatively unstable under ambient environmental conditions. Infection by the respiratory route may induce disease at doses lower than those generally associated with naturally-acquired infections by the oral route. The subsequent illness may differ from the natural pattern, and the incubation period may be much shorter.
- **Alimentary Exposure (Ingestion)**—Food and water supplies may be contaminated during an aerosol BW attack. Unwary consumption of such contaminated materials could result in disease.
- **Dermal Exposure (Percutaneous)**—Intact skin provides an excellent barrier for most, but not all, biological agents (for

example, T2 mycotoxin). However, mucous membranes and damaged skin constitute breaches in this normal barrier through which agents may readily pass.

Contamination

11. Direct contamination of consumables, such as drinking water, foodstuffs, or medications, could be used as a means to disseminate infectious agents or toxins. This method of attack would be most suitable for sabotage activities and might be used against limited targets such as water supplies of a military unit or base. Filtration and adequate chlorination significantly reduce this hazard as it pertains to water.

Other Techniques

12. Further biological dissemination methods may include the following:
 - **Vectors**—Attempts might be made to spread typical vector-borne diseases by releasing infected natural (or unnatural) arthropod host such as mosquitoes, ticks or fleas. These live vectors can be produced in large number and infected by allowing them to feed on infected animals, infected reservoirs, or artificially-produced sources of a biological agent.
 - **Secondary Aerosols**—Long-term survival of infectious agents, preservation of toxin activity during extended periods, and the protective influence of dust particles onto which micro-organisms absorb when spread by aerosols have all been documented. The potential exists, therefore, for the delayed generation of secondary aerosols from previously contaminated surfaces. To a lesser extent, particles may adhere to an individual or to clothing, creating additional but less significant exposure hazards.
 - **Interpersonal Spread**—Person-to-person spread with certain potential biological agents has been documented. Humans, as an unaware and highly effective carrier of a communicable agent, could readily become a source of dissemination (for example, with plague or smallpox).

EFFECTS OF WEATHER AND TERRAIN

Wind

13. Measured at the two metre level and is expressed in the metres per minute (mpm) for CBR incidents. This disperses the agent, however it may create a down wind problem.
14. Direction is expressed in mils or by the cardinal points of the compass. It is always measured and named from the direction the wind is blowing.

15. Turbulence is the result of wind blowing over and around obstacles such as buildings. This produces eddies and currents. This dilutes an agent cloud.

Temperature

16. High air temperatures cause removal of clothing thus people become more susceptible to liquid agent (dermal) exposure. Temperature also effects the persistence of liquid agents. Thus high temperatures will decrease persistence but increase vapour hazard. Note the corollary is also true for low temperatures (ie increased persistence but decreased vapour hazard).
17. Surface temperatures that are high increase evaporation and thus vapour hazard.
18. Temperature gradient is the variation in temperature with altitude. (This is measured at the 0.3 and 2.0 metre level for expediency and is used to determine the vertical stability of the atmosphere). There are three possibilities:
 - **Lapse**—This results from decreasing temperature with height. Occurs on clear, calm sunny days, between about 0900–1600 hrs but may be extended during summer. This causes the agent to rise rapidly.
 - **Inversion**—This results from increasing temperature with height. Occurs on clear calm nights up until daylight and on cold days with cloud cover. This will cause smoke to stay close to the ground extending any down wind vapour hazard.
 - **Neutral**—This results from a constant temperature with height. Occurs shortly after sunrise, shortly before sunset, on cloudy windy days and nights and in forests.

Humidity

19. High relative humidity, usually accompanied by high air temperature, has the effects of:
 - increased perspiration and pore size thus allowing deeper penetration of liquids;
 - degradation of the protective capabilities of CBR clothing;
 - increased susceptibility of skin to vapour/aerosol agents; and
 - breakdown (hydrolysis) of some agents into harmless by-products.

Precipitation

20. Rain washes agents from the air, buildings, vegetation and soil into drains and streams and low-lying areas, contaminating them. However, rain hydrolyses some agents into harmless by-products.
21. Precipitation increases water vapour in the air, reducing fluid evaporation (thus vapour concentration) but increases its persistence. Snow will freeze some agents (eg mustards).

Fog

22. Fog is a suspension of minute water droplets in air. It differs from clouds only in the height at which the droplets occur. Fogs will generally:
 - obstruct vision;
 - hide an agent cloud;
 - occur when an inversion temperature gradient exists; and
 - cause hydrolysis, but not to the same extent as rain.

Clouds and Barometric Pressure

23. Clouds have no direct effect on agents, however, they may alter the temperature gradient. Barometric pressure has no effect on agents.

Terrain

24. Terrain is important as it can produce local wind which may be an asset or liability as detailed below:
 - **Local Thermal Winds**—These are caused by the differential heat absorption of dissimilar surfaces. They occur when land meets water or an open area meets a wooded area.
 - **Up-Slope Winds**—These occur during the day when a strong lapse is present. The exposed side of a mountain is heated by sunshine, thus warming the adjacent air. When this air mass becomes warmer than that above, it will rise upward along the mountain slope.
 - **Down-Slope Winds**—These occur at night during an inversion and thus causes cold air to flow downward.
 - **Sea Breezes**—These occur when land is heated faster than water during the day. The warmer air above the land rises allowing the cooler sea-air to flow in.
 - **Land Breezes**—These occur at night where the land temperature drops to less than that of the sea. The air above the water rises and is replaced by colder land-air flowing in.

CHAPTER 9

HOSPITAL ISSUES

INTRODUCTION

1. A hospital should approach its planning for a CBR incident as if it were the site of the incident. However, not all hospitals will be expected to provide all services, the nominating of designated hospitals will be decided at a State/Territory level. All hospitals will require a local plan to provide limited care to casualties that may present and to ensure the protection of the facilities resources and infrastructure.

PLAN PRINCIPLES

2. In addition to current State/Territory guiding principles for disaster plans, the following points need to be considered specifically as part of the wider community. The plan must ensure:
 - a system for rapid and accurate assessment of the problem;
 - a timely response by trained people;
 - adequate resources and training are made available to staff especially in relation to external problems/ responses;
 - a system to communicate with health service control prior to patient arrival;
 - adequate resources and preparation to manage victims are available;
 - security of the facility to limit contamination spread (eg limit all entry/exit to one controlled door);
 - that protection of the facilities infrastructure and services are given paramount importance (eg air-handling systems, common corridors and wall suction);
 - the plan is an integrated sub-set of the facility Disaster plan and practiced annually;
 - a memorandum of understanding exists between the facility and the Police and Fire services, regarding roles and responsibilities;
 - the facility is part of the local emergency planning organisation to formalise recovery procedures when the facility is accidentally (or otherwise) contaminated;
 - waste management issues such as water run-off and disposal of other contaminated waste is addressed with the EPA; and

- the facility is part of the local emergency planning organisation to improve awareness and integration of community/company plans.
3. As an example, some substances manufactured and transported around our towns and cities are; chlorine; isocyanates, hydrogen cyanide; hydrogen sulfide; corrosives; flammable hydrocarbons and radioactive materials. Your facility should be aware of the industries locally and prepare appropriately.

Trade Secrets Act

4. **NB:** When informed of the make-up of a substance involved in an incident, it may be protected by a Trade Secrets Act ie whilst you may know all you need to about the composition of the substance, you are obliged not to make this known publicly.

LOCAL EMERGENCY PLANNING

5. Planning at the facility level should follow State/Territory guidelines and then be developed further to incorporate particular local issues and intra-facility potential problem areas.
6. In preparing the plan, Occupational Health and Safety Officers, Fire and Safety Officers, Fire-HAZMAT Officers and others, as suggested throughout this document should be invited to advise the planning committee.

Plan Requirements

7. Local plans should:
- identify routes, locations, and facilities where hazardous materials are stored and/or transported in the community and within the hospital;
 - establish emergency response procedures including an evacuation plan for responding to hazardous materials releases or spills;
 - set up notification procedures for responders;
 - ensure responders group is able to determine severity of release and areas likely to be affected;
 - have a notification system for all staff and patients;
 - identify equipment to be used in both an internal/external response;
 - cover acquisition and maintenance of equipment required;
 - include a training program;
 - include a test method;
 - ensure appropriate local command/coordination; and
 - ensure **Action Cards** for key positions are prepared.

HAZARDOUS INCIDENT REPORTING

8. All facilities should have some mechanism for reporting hazardous materials incidents. Much of this is covered by occupational health and safety regulations.

HAZARDOUS MATERIALS RELEASE PLANNING FOR HOSPITALS

9. The authority for the planning process will come from the State or Territory Plan. It may suggest:
 - designated hospitals for day-to-day HAZMAT incidents involved in some specialist capabilities; or
 - all hospitals have some capability to manage a HAZMAT incident (ie a plan).

THE HOSPITAL RESPONSE

10. Remember, unless for a catastrophic event, plans need to place great emphasis on infrastructure protection. Irrespective of size of incident the health care facility will be needed, therefore protection from contamination is paramount although this should not delay patient treatment.

Information Requirements

11. When informed of an incident the following information will serve to direct the preparations of the facility. Whilst the principles are the same for all agents there are some differences in the equipment requirements and the type of personal protection staff may require.
 - What is the material?
 - Is the material radioactive?
 - If the material is radioactive, what is the route of contamination?
 - How many victims were exposed?
 - Are there casualties?
 - Are the casualties from trauma or the exposure?
 - What was the degree of exposure?
 - Is there an antagonist or antidote for the substance and, if so, is there enough available?
 - How do you get more?
 - Which other medical facilities can assist in the response?

Hospital Preparation

12. When warned in advance, or upon discovery of contaminated patients, the general arrangements mentioned above and in other sections should be instituted. The following points should then be applied:

- Activation of the appropriate CBR sub-section of the plan.
- Ensure a triage officer is nominated early and staff review triage guidelines.
- Prepare the decontamination facility.
- Assemble the decontamination teams and decide PPE level required.
- Review the decontamination plan.
- Notify the State/Territory fire service (if not already involved) or decide when to notify them.
- Ensure the tracking system for patients is in place.
- Ensure the tracing system for clothing, personal belongings is in place.
- Ensure containment systems are activated.
- Ensure supplies (and back-up) of antidotes etc are arranged.
- Ensure activation of security of the facility, including need for the police.
- Activate processes to facilitate access to medical literature/experts eg poisons centre, public health expertise/information etc.
- Ensure engineering staff have activated systems to protect against contamination through or to; environmental systems; medical gases including suction; water supplies and drainage systems.

See Annex A to this Chapter for a full summary of response to contaminated patients.

GENERAL DECONTAMINATION EQUIPMENT

13. See Annex B General Equipment List for chemical, biological and radiological equipment. Also see Annex C, Chapter 6 Radiation Equipment List.

Decontamination Procedures

14. For **general** and **chemical** see Figure 3 to Chapter 6.

For **biological**—see Annex B Decontamination Procedures for Biological and Bio-Hazards

For **radiation**—see Annexes C Preparation, D Principles, E Procedure.

Wound Decontamination

15. For CBR see Chapter 6, paragraph 33 onwards.

Medical Management

16. See Chapter 3 Site Issues.
See Chapter 4 Personal Protection.
See Chapter 5 Triage.
See Chapter 6 Decontamination.
See Chapter 10 Forensic.
See Chapter 11 Mental Health.
See Chapter 12 Public Health.
See Chapters 14–16 Radiation (Nuclear).
See Chapters 17–19 Biological (WND).
See Chapter 20 Toxins (WMD).
See Chapters 21–23 Chemical (WMD).

Agents not dealt with specifically in this document are to be found in the normal reference arrangements used in Hospitals.

Pharmacological Issues

17. The approach to the storing and supplying of necessary antidotes/ antivenenes and other requirements should be based on the following guidelines:
 - Determine requirements for local industries/ activities likely to produce patients, maintaining these at the facility.
 - For major incidents designated hospitals will carry an appropriate supply (see next point).
 - At the State/Territory and national, level supplies will be held to treat a number of casualties, currently multiples of 1000 plus. This supply will be held at facilities nominated by State/Territory health departments for internal use or rapid deployment to another State or Territory.

Follow-Up and Post-Incident Care of Hazardous Materials Contamination

- 18.** Decisions on medical care and clinical monitoring must be made depending on the injuries and nature of the contaminant. Facility and equipment decontamination and clean-up must occur before the equipment or rooms can be used for other patients.
- 19.** If the incident involved radioactive material then radiation safety is responsible for collection of all biological samples as well as personnel dosimeters worn by the medical decontamination team. Radiation safety must provide an estimate of the exposure to the members of the decontamination team.
- 20.** Waste disposal must be properly carried out and all waste must be accounted for by a tracking log. Log books and records concerning the patients, must be regularly updated.
- 21.** Administrative report and critique of the handling of the incident should be completed. A group meeting with medical team to review the incident. Early psychological debriefing and interviews with patients and personnel can help prevent post-exposure stress syndrome.

Annexes:

- A. General Response to Contaminated Patients
- B. Decontamination Procedures for Biological and Bio-hazards
- C. Radioactive Contamination Emergency Department and Staff
- D. Decontamination of the Patient
- E. Radiation Patient Decontamination Procedure

GENERAL RESPONSE TO CONTAMINATED PATIENTS

Emergency Department Receiving of Patients

- The response should ensure:
 - activation of the appropriate disaster plan;
 - communication with the Health control;
 - communication with Fire and Police services;
 - predetermined locations for casualty receiving, triage and decontamination;
 - demarcation of work areas;
 - authorised personnel entry only;
 - decontamination equipment availability (see Chapter 6—*Decontamination*);
 - monitoring equipment availability including technical expertise;
 - PPE of triage and decontamination teams;
 - separate ambulance entry area to the hospital if possible;
 - triage;
 - tracking of patients and patient belongings;
 - decontamination outside the hospital;
 - medical care and decontamination inside the hospital (including a resuscitation area);
 - clean up and decontamination of the facility;
 - appropriate patient follow-up and documentation; and
 - practice setting-up area.
- Note highly likely patients will arrive contaminated, therefore consideration of some recovery plan is necessary.

DECONTAMINATION PROCEDURES FOR BIOLOGICAL AND BIO-HAZARDS

Physical contact with waste material should be prevented or minimised. Gloves should be worn along with protective eye wear if blood or fluid is handled. Bio-hazardous materials should be labelled with the standard warning sign.

Sharp's, needles and broken glass should not be directly handled. Remote instrumentation such as tongs can be used to collect such material. Special containers for sharps are available and should be used.

A dilute bleach solution (5 per cent) diluted with water (1:10) should be used to clean up body fluids and blood.

Hands must be washed immediately if they are potentially contaminated.

Personnel familiar with infection control and biologic waste disposal practices should be called on to provide clean-up services.

Any needle stick or sharps injury to personnel must be handled according to infection control policy for such injury. (In the field it may not be possible to do anything other than treat the wound.)

All health care facilities have State or Territory guidelines on infection control. These documents should be followed.

Exposure Registers (see Chapter 12—*Public Health Aspects of CBR Incidents*, paragraphs 30–36 and 45).

RADIOACTIVE CONTAMINATION EMERGENCY DEPARTMENT AND STAFF

PREPARATION

- Remove all patients and pregnant women from work zones and access corridors.
- Cover route from the ambulance to the decontamination room with polyethylene plastic secured to the floor with tape.
- Mark arrival route and entrance ways for patients with rope or 'Radioactive' sign. Use international 'Radioactive' signs.
- The decontamination room is marked with proper signs. The floors and walls are covered with polyethylene sheeting secured with tape. Ventilation to the room is turned off and ventilation ducts covered with appropriate filters or plastic. The room must be self-contained. Electrical switches and handles of doors and equipment should be covered with tape.
- A designated radiation safety officer maintains watch at the entrance of the decontamination room to monitor all personnel, equipment and samples leaving the room.
- A designated nurse is on stand-by outside the decontamination room to pass in supplies to the medical team. This person does not enter the decontamination room.
- All equipment in the room essential to the care and decontamination of the patient and must remain in the room until cleared by radiation safety officer.
- Protective garments are worn by decontamination team. Two pairs of gloves should be worn. The inner gloves are removed as the last pieces of protective equipment as the person exits the room post decontamination. The minimum protection includes surgical scrub pants and shirt, cap, masks, shoe-covers. Surgical gown with sleeves taped, two pairs of gloves and eye protection.
- All personnel entering and leaving the room must be surveyed by the radiation safety officer contamination. Contaminated items and clothing must remain in the room.

IDENTIFICATION TAG INFORMATION FOR RADIOACTIVE CONTAMINATED PATIENT

- Name, employer, and company identification number.
- Health physicist name and telephone number.
- Injuries and pre-hospital treatment.

- Skin contamination details should include:
 - type of contaminant (gamma, beta, alpha);
 - location (body chart, front and back); and
 - dose rate and/or count measurements before and after contamination.

- Decontamination methods and solutions used for internal contamination:
 - Name of radionuclide.
 - Chemical and physical form.
 - Solubility.
 - Route of contamination (wound. inhalation. ingestion).
 - Nasal swab counts.
 - Wound counts.
 - Whole body counts.
 - Bio-assay samples collected.
 - Pre-hospital treatment.
 - Hospital treatment.

- Decontamination methods and solutions used for external penetrating radiation:
 - Location and position of patient relative to source of exposure.
 - Time of exposure.
 - Duration of exposure.
 - Personal dosimeter-collected.
 - Symptoms.
 - Treatment.

DECONTAMINATION OF THE PATIENT

PRINCIPLES

- Reduce the exposure of the skin to radioactive materials.
- Prevent or reduce systemic absorption.
- Contain the contaminant.
- Predetermined team is composed of the physician leader, nurses, radiation safety experts, and other designated technical assistants.
- A call-up list of experts should be developed as a component of the disaster plan.
- No other personnel should be allowed to enter the decontamination zone.
- Personnel should wear surgical scrub suits with masks, caps, two pairs of gloves and rubber or plastic shoe covers.
- The team leader should be trained in safety and experienced enough to recognise the need for personal respirators in the event of heavy contamination of the victims with radio-nucleotides.
- All members of the team should be trained in the use of radiological monitoring equipment and decontamination procedures.
- The decontamination team should also wear Plastic or rubber aprons during the actual washing of the victims.
- Excessive splashing of wash solution should be discouraged.
- Eye protection should be worn by the decontamination personnel.
- Personal dosimeters should be worn by all members of the team.
- Exposure to radioactive material is monitored by radiation safety experts, and team members should be rotated as necessary to avoid cumulative doses above five rems.
- In relation to the patient.
- Patient triage for serious medical conditions.
- Management of serious wounds and medical conditions.
- Evaluation of contamination extent and location,
- Internal contamination management;
- External contamination management.

RADIATION PATIENT DECONTAMINATION PROCEDURE

- Triage, treatment and decontamination of patients directed by the doctor in- charge.
- Radiation safety officer monitors patient front and back. Contaminated areas are recorded on patient cards or tags. (body charts)
- Patient's clothes are removed and sealed in plastic bag containing proper patient identification.
- Routine cotton swab samples are obtained of mouth, conjunctivae and nasal mucosa and ear canals and placed in sample containers marked with the patient's identification.
- Other samples are obtained as needed such as of wound sites and all skin contaminated areas. Samples are given to radiation safety officer for proper storage.
- Radiation safety officer monitors all decontamination personnel and biological samples obtained during management and decontamination.
- Clinical assessment identifies medical needs of the patient. Patients with contaminated open wounds have priority.
- Contaminated wounds:
 - Begin decontamination treatment with DTPA as soon as possible. (Soap can be used as an alternative.)
 - Open wounds are washed with normal saline for three to five minutes and re-monitored for contamination level. This step is repeated if contamination persists.
 - Persisting contamination of open wounds despite repeated saline washing can be managed with a three per cent hydrogen peroxide wash.
 - Contaminated tissue not successfully removed by repeated washing may require surgical debridement. Surgical debridement may be necessary if the radionuclide is toxic, has a long half-life and is not removed by appropriate decontamination methods.
 - Save and label all tissue removed and place in appropriate specimen containers for storage by radiation safety.
 - Cover all decontaminated wounds with sterile dressing and protect them from other areas of the skin that may be undergoing decontamination.
- Contaminated eyes, ears, mouth, nose:

- Irrigate eyes with water or saline. Do not allow cross-contamination to the other eye during irrigation.
- Irrigate ears with warm saline or a 50–50 mixture of warm saline with three per cent hydrogen peroxide using a bulb syringe. Monitor decontamination process and repeat irrigation as needed. Do not allow irrigation solution to flow into patient's mouth, eyes or wounds.
- Irrigate nose with saline using a bulb syringe. Have suction available and do not allow patient to swallow irrigation solution. Monitor irrigation for radioactivity during the process.
- Have patient irrigate mouth without swallowing the water. Insert nasogastric tube into stomach and monitor contents of stomach for radioactivity. If gastrointestinal contents are contaminated then lavage stomach until clear and begin decontamination with DTPA.
- Monitor level of decontamination and repeat irrigations as needed.
- External contamination:
 - Decontamination of the skin should begin with mild washing and gentle scrubbing using a detergent and water. A soft sponge or soft brush should be used to avoid skin abrasions. Monitor both skin and washing fluid for radioactivity and repeat washing three to four times to remove residual contaminant.
 - For residual levels of contamination use a mixture of 50:50 corn meal and powdered detergent mixed in water to form a paste. Gently scrub the skin with this mildly abrasive material using soft sponges.
 - For contamination persisting beyond the above efforts a five per cent sodium hypochlorite solution (HTH) can be used either as full strength over most areas or diluted 1:4 with water for areas like the face and neck.
 - Citric acid three per cent can be applied to the areas and rinsed off with water.
 - For persistent contamination and in extreme cases only the application of four per cent potassium permanganate followed by a four per cent sodium bisulphite rinse may be tried. Potassium permanganate is an oxidiser and will stain the skin as well as remove the outer layer of skin.
 - All skin areas front and back should be decontaminated until radiation safety agrees that the process is successful.
 - Washing's are collected in a containment vessel.
 - Avoid splashing decontamination fluid and do not allow washing's to contaminate eyes mouth other mucous membranes or wounds of the patient.

- Contaminated hair is washed with water and soap, then rinsed and monitored. Repeat as necessary. Hair may have to be cut. Do not shave hair due to risk of cutting skin.
- Patients may be removed from the decontamination room after radiation safety indicates that the level of contamination is safe. The patient should be dried. All materials should remain in the decontamination room. Wounds can be closed as needed after decontamination. Monitoring of patients and personnel is performed before anyone is allowed to leave the room.
- Entire body of patient is monitored by radiation safety before leaving room.
- All previously sampled areas should be re-sampled and labelled as 'post-decontamination' with time and patient identification.
- New polyethylene floor covering is laid-out from the patient to the door of the decontamination room and a clean stretcher is brought into the room. The patient is placed on the stretcher by a clean team and removed from the room. The process is monitored by radiation safety.
- Decontamination team exit:
 - The team may be rotated in and out depending on the level of contamination. This will be guided by radiation safety.
 - An exiting team member will go to the designated 'clean' line at the door of the room. All protective Clothing will be placed in a predesignated drop zone or placed in a predesignated container. Outer shoes are removed first. Personnel monitors are then given to radiation safety officer. Remove tape from sleeves and trouser cuffs. Remove outer surgical gown then shirt and pants. Shoe covers are removed one at a time. Radiation safety monitors the first shoe and if clean the person can step over the line into the clean area and remove the second shoe cover. The inner two gloves are then removed after the person is over the clean line. and they are dropped into the designated area.
 - The team member then showers and is re-monitored by radiation safety officer for any contamination.

CHAPTER 10

FORENSIC ISSUES

INTRODUCTION

1. Whilst guidelines do exist for handling the dead, procedures at the time will be decided by the coroner on advice from forensic pathologists and other expert groups. The need for decontamination, containment, devices for burial, cultural requirements, use of adsorbents/neutralising substances and burial procedures eg cremation or burial, will pose many psychosocial issues that must be considered at the time.

BACKGROUND

2. Where a weapon of mass destruction is employed there is a high probability of multiple deaths producing a plethora of problems including legal, medical, coronial and humanitarian.
3. Within each State and Territory of Australia the respective coroners have the responsibility for determining the time and cause of death and the identity of the deceased. Based on international standards an incident involving five or more deceased is classified as a disaster. Due to the nature and complexity of many mass casualty incidents specific procedures are implemented at all disasters to ensure the identification of the deceased to the satisfaction of the coroner.
4. In most jurisdictions in Australia where a medical practitioner is available, the establishment of the fact of death must be performed by a medical practitioner. The coroner must take possession of the bodies for the purpose of his inquiry/inquest.

Disaster Victim Identification

5. Disaster victim identification (DVI) is the procedure used to identify deceased victims of a multiple casualty incident.
6. In the normal response pattern to a CBR incident distinct geographic areas will be established, designated from core to periphery, the hot, the warm and the cool zones. It may be necessary for medical practitioners/forensic pathologists and forensic technicians to enter the hot zone to assist with the establishment of the fact of death or, more probably, aiding the investigating authorities in recording and supervising their orderly extraction to the warm or a cold zone.
7. The responsibility for DVI rests with the DVI Commander. The position of DVI Commander in each State and Territory is held by a senior police officer with knowledge and experience in DVI procedures and processes.
8. Identification of deceased is not only a legal requirement but is also a social responsibility on the officers accountable for the task. Whilst the legal aspect of

identification is obvious the repatriation of deceased with relatives is an extremely important process. DVI also acts as the framework for the investigation of the incident. Should inquiries reveal the incident to be a crime the adoption of correct crime scene procedures is imperative.

PROCESS

Disaster Victim Identification

9. DVI comprises five (5) distinct phases:

- **Phase One: Scene**—Where an incident is designated as a disaster the scene is treated as a major crime scene and human remains are left in situ until the arrival of crime scene examination and DVI teams. The teams comprise DVI trained police officers from primarily the forensic services area. Individual members of the team are responsible for the recording, photographing and searching of body and remains. The scene is photographed and the position of human remains recorded. The human remains are labelled (tagged), recovered and transported to the mortuary. Property (both personal and other) located at the scene is collected and labelled and its location (where it was found) is recorded.
- **Phase Two: Mortuary**—On arrival at the mortuary details of human remains are logged and the remains placed in a secure cold storage area. The human remains are then examined. The methods used include visual, photography, fingerprinting, radiology, DNA, odontology and autopsy examinations. Due to the potential problems associated with correct identification by visual means, in disaster situations, identification is not achieved by visual alone. It is preferable that deceased are identified by fingerprints, odontology or DNA. Jewellery, personal effects and clothing is photographed in situ, collected, examined, cleaned, re-photographed and secured. On completion the human remains are returned to storage pending the final formal identification and release by the coroner.
- **Phase Three: Ante Mortem Information Retrieval**—While the above phases are being conducted information is gathered in relation to the potential victims of the incident including any passenger manifests and completion of detailed missing person reports by the police. Information sought includes full description of persons, description of jewellery and clothing, dental records, medical histories, radiographs, photographs etc.
- **Phase Four: Reconciliation**—In the reconciliation stage ante mortem and post mortem information is matched in order to affect identification of the deceased. The coroner is informed of the results of the identification process.
- **Phase Five: Debriefing**—Operational debriefing is conducted at the completion of any DVI incident to address issues such as the effectiveness of the operation together with occupational health and safety issues. Effective debriefing permits recommendations to be made which can improve the management of future incidents.

10. Critical incident stress debriefing (CISD) is made available to all personnel involved in the DVI incident.

CBR and the Scene

11. The problem and response to an incident will be modified in detail by the nature of the event. With the use of microbiological agents except to some extent, toxins, unless the perpetrators announce the fact that an event has taken place, the first manifestations would be unlikely to appear much before 24 hours and it may be several days before the first deaths or the nature of the problem emerges.
12. This would not be true of most chemical agents, where the first manifestations of release of these agents may well occur within seconds.
13. A critical factor in any DVI exercise is the scene. The management of the scene of a disaster will follow general crime scene procedures. Correct scene procedures must be adopted prior to the removal and identification of bodies and human remains. The scene must be thoroughly recorded and examined. At a large disaster scene, DVI and the incident investigation may be two distinct roles undertaken by separate crime scene teams. However, both functions will require coordination and liaison.
14. Entry into a crime scene is to be restricted to only those persons who have a legitimate right to be there. The more people present at a crime/incident scene, the greater the potential for contamination, destruction of evidence and risk to personnel safety.
15. The nature and size of the scene can be based upon a number of factors including:
 - the number and type of casualties;
 - property damage (safety to emergency personnel and victims);
 - type of incident (chemical, biological, radiological, explosive); and
 - assessing any other possible hazards (gas, electricity, water etc).
16. The most important factor affecting the interpretation of physical evidence is the ability to find it and to preserve it in the condition it was at the time of the crime or incident. Forensic evidence can be minute, can be very easily lost, destroyed or contaminated.
17. Where an incident is classified as a disaster the scene is treated as a crime scene. The nature of the incident will dictate very much the actual procedures that will be adopted. In all cases the bodies/human remains and associated personal property are left in situ until the arrival of the crime scene investigators and DVI teams. The scene will be photographically recorded. Bodies and human remains will be tagged with individual identifiers, photographed and position recorded. Any property found at the scene which can be clearly

identified as belonging to a specific deceased will be labelled with the same reference number.

- 18.** In the event of a CBR incident flexibility will be required in dealing with the scene phase. It is critical that prior to entering the scene, information is available which clearly identifies the agent used, the contamination levels and the danger to those entering the hot zone. Once the information is available a suitable operational strategy will be implemented.
- 19.** Should intelligence not be available regarding the agent used and the danger to those entering the hot zone, it will be presumed that the site is extremely dangerous and level 1 safety precautions will be implemented. In such a scenario DVI team/teams comprising a forensic pathologist and a crime scene DVI officer will enter the hot zone to certify death. Once a body has been certified a pre numbered DVI dead tag will be attached to the body. A similar identification process will be adopted with recognisable body parts. The scene recording will be restricted to a crime scene officer recording the incident by video. The video recording will include scene shots, bodies and property in situ, recording of all other items or things which may assist in the crime scene investigation and the identification process of victims. The accurate recording of information is essential in the identification process and also as a record of proceedings in any coronial hearing or inquest.
- 20.** International procedures recommend that scene information required on the pink DVI post mortem form be completed by an officer whilst at the scene. Where possible this procedure should be adopted. But when the danger in the hot zone is high and where the safety clothing that is required makes the function of recording impossible, the recording is to be conducted away from the scene in the cool zone.
- 21.** Proper safety precautions will be employed by any DVI officer entering the scene. Prior to entering the hot zone permission must be gained from the DVI scene coordinator who will ensure proper OHS procedures are used.
- 22.** Once a body has been certified as dead, tagged and photographically recorded in situ it is to be removed from the incident site to a temporary morgue. A temporary mortuary will be set up in the cool zone away from the command centre and general traffic area to accommodate the temporary storage of bodies pending removal to an appropriate mortuary facility. Transportation arrangements will be arranged by the DVI Commander for the removal of bodies from the incident site to the permanent mortuary.
- 23.** Should it be deemed necessary to strip the bodies to decontaminate prior to removal from the site, any clothing removed from a body must be placed in a sealed plastic bag. The bag is to contain the same identification number allocated to the accompanying body. The bagged body and the clothing are to be transported by the carrier to the mortuary.
- 24.** Where the coroner is inquiring into a death or series of deaths, normally full autopsy would be required. Where a multiple death incident has occurred this may present certain practical difficulties. Most States have an intrinsic capacity

to deal with a limited number of bodies in this fashion. However, as the numbers of deaths increase, then provision will have to be prearranged for assistance from neighbouring States. Most forensic institutes or State disaster plans can facilitate this.

Autopsy

- 25.** The purpose of the coronial autopsy must also be borne in mind. It is to assist the coroner in determining who has died, when, where, how, and by what manner the death occurred. To this end, it seeks to detect, diagnose and describe the pathological processes and to apply the knowledge gained to the coronial function. In a CBR scenario the forensic pathology team may well make the earliest definitive diagnosis. Therefore, speed is of the essence in formulating that diagnosis on the best available basis in the shortest possible time, and informing the public health authorities of the result of the various investigations, in addition to the normal role of supporting the coroner. Indeed, expeditious and accurate diagnosis (whether based on clinical or pathological grounds, or a combination) is crucial to the management of the event.
- 26.** In some incidents the number of dead may exceed the coroner's capacity to respond in the conventional manner with autopsies on all cases. Here, an agreed selection process resulting in sample autopsies will have to be implemented. This decision and the details of the sampling process will be discussed with the coroner by the forensic pathologist who has been designated the Case Officer. Here again the optimum process may not be practical. Even those bodies where a full autopsy is performed may, by weight of numbers, stretch the identification capability within any given jurisdiction, and a decision may have to be made by the coroner, as to which bodies may be disposed of unidentified.
- 27.** Wherever possible full identification procedures will be conducted on all deceased for the purpose of positive identification. Identical matches of fingerprint or dental between ante mortem and post mortem will stand alone as positive identification. Each incident/situation will have to be evaluated and treated on its merits. There are guidelines for the autopsy of persons who have died from specific communicable diseases. Where there is any fear of contamination, officers working within the mortuary will treat all deceased in a similar manner to HIV and hepatitis C patients by wearing full safety head suits with internal positive breathing apparatus. All examinations will be conducted within a special decontamination room, which will be decontaminated at the completion of each examination.
- 28.** Should it be deemed unsafe to conduct odontology examinations on victims, radiographs may have to be taken through the sealed body bag for comparison with ante mortem material.
- 29.** Where visual identification from photography is possible, identifying features of the bodies will be photographed and recorded and the bodies placed in clearly marked body bags. The bodies with a code identification tag will be then placed in body bags and the body bags also clearly marked. If burial is an option, then the bodies should be buried in a mass grave in a single layer in a clearly

identifiable position clearly recorded to facilitate subsequent exhumation, should this be required. The interment should take place in a designated cemetery. The public health authorities may require the bodies to be cremated. Irrespective of the means of disposal, all bodies should have blood or tissue samples removed from them sufficient to have DNA profile prepared, and adequate provision should be made to have this profile run prior to disposal of the bodies. As most bodies should be ultimately identifiable should the relatives wish, the buried body can subsequently be exhumed for return to the next of kin, executors etc. Likewise, in the cases where cremation is the only option, it may be possible to retain the ashes of individual bodies in identified and recorded containers.

CHAPTER 11

MENTAL HEALTH ISSUES OF HAZARDOUS MATERIALS EXPOSURES

CHEMICAL, BIOLOGICAL AND RADIOLOGICAL TERRORISM

1. The threat or actuality of chemical, biological and radiological terrorism will evoke intense fear and a range of other psychological reactions. These may at some stages be difficult to distinguish from the impact of each of these environmental threats. It is important that those responding recognise these responses and that triage includes a knowledge of possible anxiety, panic, depression and other reactions and their potential differentiation from or interaction with any organic effects. Expert psychiatric knowledge and skills should be available to assist this process in the shorter and longer term.
2. Management of the psychological as well as physical reactions is central, as resources, such as emergency rooms, may be swamped by people panicking about possible exposure.

Effects of Chemical and Biological Affects on Mental Status

3. In an excellent review of these effects DiGiovanni, (1999) highlights the fact that many people will show symptoms such as tension, tachycardia, tremors and increased respiratory rate. These reactions may reflect anxiety but can be confused with chemical exposure, particularly to nerve agents such as sarin, tabun, soman and VX. Depression, restlessness, irritability, problems with vigilance, concentration and memory have all been described as potential effects of such agents or similar organo-phosphate compounds. These effects may appear both acutely and persist or may be related to neuropsychiatric and psychological reactions.
4. Atropine, when given in the high doses necessary to counteract potential effects of these agents (eg 60–100 mgm in first 24 hours) can produce psychiatric side effects. These may include hallucinations, hyperactivity and coma.
5. Blister agents can produce delirium and psychological distress from their physical effects.
6. Biological weapons may include anthrax, viral agents, small pox and others. These may produce fear initially about potential exposure but also neuropsychiatric effects as the infection takes hold, particularly with respect to any encephalities, toxic effects and other organic changes. Delirium, may result in the acute phase, and depression, irritability and cognitive changes in the longer term.

Psychological Impact

7. These threats are unlike those of other disasters in that the agents are for the most part 'invisible' and the level of exposure may not be known immediately for there are no 'familiar' signs. DiGiovanni suggests these agents pose sudden unanticipated and unfamiliar threats to health. They may be transient, recurrent, or prolonged. Issues of potential or actual contagion are particularly frightening. Such threats are more likely to be associated with fear, panic and 'contagious somatization'. The latter refers to the anxious focus on and even search for, any physical reactions that may suggest exposure, and as well they may present with psychologically determined body symptoms.
8. These anxiety and other psychological effects may appear in individuals, families, communities, and indeed staff as responders.
9. Longer-term psychological impact of these exposures may include anxious somatic preoccupation, sleep disturbance, anxiety disorders, phobias, major depression, post-traumatic stress disorder and substance abuse. The symptoms of any one of these disorders may be difficult to distinguish from longer term neuropsychiatric effects of exposure, although frequently psychological responses predominate.
10. Stressors such as ongoing and uncertain threat, loss of loved ones, dislocation, break up of communities, loss of property and property value, work or workplace may all contribute to the adverse mental health consequences. Some of those affected may become committed to an unending search for an 'acceptable' diagnoses (ie not psychological or psychiatric). There may be a profound belief that the toxic, radiological or other agents have damaged the health of the individual or family and this may not respond either to evidence to the contrary or negative tests and investigations.

Psychological Effects of Response

11. The uncertainty about exposure means that few incidents are viewed as a 'hoax'. Initially, at least protective segregation, vaccination, treatments, 'moon suits' for protection of responders, programs for handling mass exposure, washing away toxic substances, epidemic containment, response to nuclear incidents, may all have secondary psychological impact. The protective clothing or masks may increase risk of fatigue, heat and isolation stress, as well as creating communication difficulties. Holloway et al (1997) have suggested that the process of seeking and receiving immunization is in and of itself potentially stressful, even before any incubation period of a biological agent has been passed.
12. Provision of accurate information from respected sources is critical to reassuring those affected and a well-organised response will decrease arousal.

MANAGEMENT

Preparation and Training

13. Preparation and Training should encompass a recognition of potential neuropsychiatric, psychological and other responses and action plans to deal with these such as cognitive techniques of stress management, focus on achievable tasks, and knowledge of how to handle these reactions in others.

Information

14. Information management is critical. Information should be accurate, provided by trusted sources, identify limitations and what will be done to deal with problems and provide advice on appropriate actions for those affected.
15. Information should be repeated at regular intervals and updated. It should be clear, brief and to the point, readily understandable and available in major community languages.
16. Communication of information should be clear at individual, group and community levels. It can significantly decrease anxiety, hyperarousal and panic, and focus activity appropriately.

Immediate Response to Threat

17. Information is essential, as is the first level of individual counselling or group support. This is usually in the form of psychological first aid. This involves approaching and offering support, reassuring and ensuring safety, comforting and communicating. If the person or persons wish to talk about their experience this can be supported but it is inappropriate to probe for psychological reactions at this early stage. Information necessary for appropriate actions should be sought and provided. Links with families and significant others should be ensured whenever possible and support provided where there is separation.
18. Engaging those affected in family or other groups can facilitate mutual support and be a focus for activities to deal with threat and aftermath. Such groups can carry out specific tasks to assist one another and contribute to the overall response. This helps psychologically through the beneficial effects of a sense of purpose, reinforcing adaptive coping and targets.

Triage

19. Triage is critical in these circumstances of threat. As noted above it needs to take into account psychological, psychiatric, and neuropsychiatric effects, for instance anxiety, depression, organic brain effects, panic, delirium, cognitive impairments, and their potential sources. While this differentiation can be difficult, confusion about time or place, presence of hallucinations, extreme levels of fear and arousal all suggest potential acute organic effects.

Management of Acute Effects

20. Management includes reassurance, information, practical, cognitive and behavioural techniques to decrease anxiety and depression, protection and sedation if appropriate. When there are neuropsychiatric effects, appropriate specialist diagnosis and investigations may be required. Benzodiazepines and other anxiolytics may be relevant to the management of anxiety that is disabling in the short term.

Group Discussion and Support

21. Although critical incident stress debriefing has been popularised there is no evidence that it is effective in preventing post disaster/threat morbidity in such circumstances, particularly as the threat is likely to be ongoing. Some group discussion may be helpful for those who wish to talk about their experience with others who have 'been through the same experience'. However, unless this is supported by strong leadership and provision of relevant information it may readily generate further anxiety and new somatic concerns. Group processes should be focussed on mutual support, information about threat and how to deal with it, and strategies for positive action.

Prevention and Treatment of Psychiatric Disorders Arising Post Incident

22. Specific treatments for identified disorders may be necessary. These may involve cognitive behavioural, other counselling techniques often best applied after the early weeks and for those at higher risk (eg acute stress disorder) (Solomon, 1999). Specific treatments for other disorders may also include antidepressants, anxiolytics and other medication as well as psychotherapies.

Children and Families

23. Children and families may require special attention particularly if they are at high risk through separation, death or loss, or because of particular focus (eg mothers of young children in nuclear incidents). Keeping families together, teaching parents simple anxiety management techniques and again providing information are all helpful.

Rehabilitation

24. Rehabilitation to promote a rapid return of full function in work and personal spheres is essential, and often not well provided in the post incident period but

critical for longer term outcomes. It is particularly important in overcoming feared situations and regaining a sense of mastery.

- 25.** Managing potential longer term effects for individuals and communities requires a recognition of the concepts of 'contaminated communities' and the social damage as well as chronic psychological effects. Information, active planning for renewal and recovery are relevant from the earliest period.

CHAPTER 12

PUBLIC HEALTH ASPECTS OF CBR INCIDENTS

INTRODUCTION

1. With the exception of some of the toxins (botulinum, SEB, T-2 mycotoxin), and possibly the haemorrhagic fevers, the initial signs and symptoms produced by the biological agents are non-specific and include fever, chills, fatigue, headache, muscle or joint pain, a cough or chest pain. Blood in the excreta or petechiae (pin point-size, haemorrhagic spots on the skin) may lead an astute clinician to consider a haemorrhagic fever, but few practitioners are likely to recognise the other diseases associated with biological weapons on the basis of signs and symptoms alone.
2. Correct diagnosis will almost certainly depend on the perception of an unusual epidemiologic picture by public health epidemiologists. This is an area where pre-incident intelligence could have a major impact in reducing numbers of casualties.
3. The Institute of Medicine in the USA emphasises the importance that public health epidemiology will play in the event of a CBR event.

EFFECTS ON THE HEALTH OF THE PUBLIC

4. CBR incidents may have a range of impacts on public health.
 - The direct effect of the agent on:
 - the individual directly exposed;
 - those on the fringe areas of the contamination zone; and
 - emergency workers and others assisting particularly in the early stages when the agent may not be known and appropriate precautions specific to the agent may not be implemented.
 - The immediate and longer-term disruption to:
 - normal daily routines of commerce and essential services;
 - access to food and medication; and
 - all normal health services, particularly laboratory services in the case of a biological incident.
 - There may be long-term problems due to contamination of:
 - food sources such as farms and market gardens; and
 - commodities stored in shops, factories, warehouses;

- water supplies;
 - food and food displays which may be the target for deliberate contamination (sabotage) with these agents at manufacturing or retail level; and
 - public places, work environments, homes.
5. The mental health effects will also be cause for widespread concern and are dealt with elsewhere (Chapter 11).

PUBLIC HEALTH SERVICES

6. The current capability of public health systems in Australia covers a wide range of activities at the three tiers of government.

Local Government

7. Local government capabilities are described below:
- All have health responsibilities that embrace sanitation, hygiene and food safety.
 - They may or may not provide essential services such as power and water.
 - They will have some investigation capacity and a few may have limited epidemiological surveillance expertise.

State and Territory Government

8. State and Territory governments have:
- A strong environmental health capacity supplemented by experts in toxicology, pharmaceuticals, radiation control and epidemiology (including cancer, injury, perinatal events and infectious disease).
 - Infectious disease epidemiology units that maintain surveillance systems.
 - Investigation capacity and can deploy specialist investigators.
 - Developed networks for the provision of public awareness campaigns and dissemination of information.
 - Interstate links and connections to other government departments/authorities.
 - Access to overseas computer-based systems designed to track diseases of importance and to scan for evidence of new disease outbreaks.

Commonwealth Government

9. The Commonwealth has a capacity to coordinate State and Territory activities in environmental health and communicable disease matters. It also has

important roles in disseminating information, in education and acts as a link into the national infectious disease authorities overseas as well as the WHO.

BIOLOGICAL HAZARDS

- 10.** The National Communicable Disease Surveillance System is maintained by the Department of Health and Aged Care, which collates notifiable disease data from all States and Territories. Information on virus isolations is also collected from sentinel laboratories around the country. The Department of Health and Aged Care publishes Communicable Disease Intelligence and maintains a website at <http://www.health.gov.au/hfs/pubs/cdi/cdihtml.htm>.
- 11.** The Communicable Disease Network – Australia, New Zealand (CDNANZ) provides a mechanism for confidential communication between all State and Territory communicable disease control units. Fortnightly teleconferences are held and ad hoc meetings can be called within an hour or so if required. CDNANZ has a capacity to coordinate the provision of additional expertise to States and Territories that need help with large-scale investigations.
- 12.** The Public Health Laboratory Network (PHLN) is a collaborative group of laboratories, nominated by State and Territory health departments, which have expertise and provide services in public health microbiology.
- 13.** The PHLN was established as part of the implementation of the National Communicable Diseases Strategy (NCDSS) to complement the Communicable Diseases Network Australia New Zealand (CDNANZ). Its aim is to provide strategic advice, define priorities and share expertise nationally, to enhance laboratory-based communicable disease surveillance in Australia and New Zealand.
- 14.** The PHLN is the first point of contact to identify individuals or laboratories with appropriate expertise for unusual outbreak investigations. It has worked collaboratively with CDNANZ to:
 - advise coordination of laboratory testing during outbreaks of national significance;
 - facilitate outbreak identification and follow-up;
 - develop the role of laboratories in dealing with possible bio-terrorism incidents; and
 - provide a laboratory perspective for the influenza pandemic preparedness plan.
- 15.** A training scheme for infectious disease epidemiologists based at the Australian National University has students posted to departments around the country. These students, undertaking the Masters of Applied Epidemiology program, augment the investigatory capacity of the States and Territories.

RADIOLOGICAL HAZARDS

WHO Collaborating Centre for Radiation Protection

- 16.** The former Australian Radiation Laboratory (ARL) was designated a WHO Collaborating Centre for Radiation Protection in 1985. In 1989, ARL was redesignated jointly with the Peter MacCallum Cancer Institute as a Collaborating Centre for Radiation Protection and Radiation Emergency Medical Assistance (CCRPREMA). In February 1999 ARL was combined with the Nuclear Safety Bureau to form the Australian Radiation Protection and Nuclear Safety Agency (ARPANSA). These two organisations, ARPANSA and the Peter MacCallum Cancer Institute, form the WHO Collaborating Centre.
- 17.** The Terms of Reference of the CRPREMA are to:
- help in developing radiation protection standards and codes of practice for the safe and effective use of radiation;
 - provide technical advice and to organise personnel training in radiation health when needed;
 - define optimal methods for diagnosis and treatment of overexposure;
 - help member States in elaborating their plans for medical preparedness and first aid;
 - promote training of personnel in developing countries in medical preparedness and first aid;
 - provide medical assistance to exposed persons, both on site and in specialised clinics, subject to bilateral agreement between Australia and country(s) involved;
 - help in developing radioactivity environmental monitoring in the region;
 - disseminate on a regional basis information on radiation health; and
 - participate in the regional dosimetry intercomparison program.

Radiation Protection and Public Health

- 18.** The Australian Radiation Protection and Nuclear Safety Agency (ARPANSA) is a new Federal Government agency charged with responsibility for protecting the health and safety of people, and the environment, from the harmful effects of radiation. Specifically, ARPANSA is responsible for:
- promoting uniformity of radiation protection and nuclear safety policy and practices across jurisdictions of the Commonwealth, the States and the Territories;
 - providing advice to government and the community on radiation protection and nuclear safety;

- undertaking research and providing services in relation to radiation;
 - protection, nuclear safety and medical exposures to radiation; and
 - regulating all Commonwealth entities (including departments, agencies and bodies corporate) involved in radiation or nuclear activities or dealings.
- 19.** ARPANSA provides the radiation protection input to the CCRPREMA. ARPANSA has formal commitments to providing assistance for radiation accidents associated with visiting Nuclear Powered warships and for emergencies associated with re-entry of Nuclear Powered Satellites. In the event of a radiation accident or radiation emergency, and when requested by the responsible State or Commonwealth authorities, ARPANSA provides health physics advisors and health physics teams. ARPANSA provides environmental sampling and personal radiation monitors during visits by nuclear powered warships. ARPANSA provides health physics support to the National Satellite Re-entry Plan.
- 20.** ARPANSA has a single health physics team on 24 hour call, with a planned deployment time of three to four hours. The initial contact with the laboratory is through a designated duty coordinator, using a special mobile telephone number. ARPANSA has equipment and human resources for another five health physics teams.
- 21.** The laboratory also maintains:
- facilities for the radio analysis of environmental and other samples (food, water, etc);
 - facilities for whole-body radiation monitoring of exposed individuals; and
 - an Australia-wide network of radiation fallout monitoring stations computer models for the assessment of radiation dose following a radiation emergency.

Radiation Emergency Medical Assistance

- 22.** Peter MacCallum Cancer Institute is Australia's foremost cancer treatment centre and is the largest radiation oncology facility in the southern hemisphere. It provides the medical input to the Australian CRPREMA for REMPAN (Radiation Emergency Medical Preparedness and Assistance Network). Historically Peter MacCallum Cancer Institute was established as a free standing radiation oncology institute and has developed associated cancer treatment services since then. Hence the hospital does not have an emergency department or general medical and surgical facilities on site but collaborates with the other general hospitals in Melbourne for these services. However, a comprehensive range of radiation oncology services, haematology and medical oncology facilities are available and supported by a large health physics staff and research facilities.
- 23.** The Peter MacCallum Cancer Institute (PMCI) has 135 registered acute care beds. The medical staff comprises:
- 24 EFT radiation oncologists;
 - 8 EFT medical oncologists; and
 - 4 EFT haematologists.
- 24.** PMCI Services and Responses include:
- dose/exposure estimation and medical assessment;
 - advice on decontamination and treatment;
 - management of patients with radiation sickness;
 - risk assessment regarding radiation-induced complications; and
 - advice to other medical practitioners on management of radiation injuries/complications.
- 25.** All sophisticated medical treatments are available in each State, at least within each capital city. Whilst all these facilities are not available in any one hospital they can be accessed as needed for particular patients medical requirements. Expert advice on radiation medicine is available in each State but it is most probable that the first line medical response in a radiation accident in Australia would be the local acute general hospital. This is appropriate as these hospitals manage acute trauma routinely. In the event of accidents involving radiation, these hospitals can access the physics and radiation medicine advice they need by contacting the local State Radiation Centre or via ARPANSA.
- 26.** The staffing of Emergency departments changes frequently in our hospitals and there is a continuing need for education and training of medical and nursing staff to respond appropriately to accidents involving radiation. Peter MacCallum Cancer Institute and ARPANSA need to ensure that this is a continuing activity. In a country without a nuclear power industry and where the potential for a major incident involving radiation is considered small and with health funding

budgets which are progressively being reduced, it is impossible to get any individual hospital to fund this training activity. Some national funding and coordination for this activity will be necessary and ARPNSA is best equipped to pursue this.

27. The future aims should be to:

- maintain current in service provision and provision of medical advice;
- increase the dissemination of medical information on radiation injury to acute general medical facilities as well as radiation centres; and
- increase availability of education and training in emergency response to accident involving radiation to key acute hospitals in each State of Australia.

FOOD-RELATED HAZARDS

28. The Australian and New Zealand Food Authority (ANZFA) is the national coordinating authority for food contamination issues. ANZFA, in conjunction with State, Territory and industry networks has established government and industry protocols to deal with the recall of food within Australia and New Zealand. These procedures are accessed through the State and Territory Health Departments. There is a 24 hour a day response capacity.

29. Food sabotage issues may be dealt with differently by each State and Territory and may include the immediate notification of police special response squads in accordance with State protocols on suspicion of any criminal activity.

Epidemiological Surveillance

30. Epidemiological surveillance involves the continued close observation of patterns of ill health and disease and the activity of infectious agents in a community, to detect events that are out of the ordinary. Surveillance systems may be passive or active. The majority of routine surveillance systems in Australia are passive:

- ***Passive Surveillance:***
 - relies upon voluntary reporting by doctors or others alerted to a hazard or by people affected by the hazard;
 - tends to be slow and incomplete in capture of data;
 - is of limited use in a CBR incident; and
 - may be supplemented by mandatory laboratory reporting which may be more complete and timely.
- ***Active Surveillance:***
 - requires deliberate searches be made for cases or events;

- generally has a high ascertainment of data;
 - timeliness varies according to the frequency of contact made with the sources of information;
 - more expensive to maintain than passive systems; and
 - demands that the collection of data is followed by rapid analysis and interpretation.
31. The choice of system may depend on the level of sensitivity required, timeliness of reporting and the need for short, medium or long-term monitoring.
 32. Regardless of whether the system is passive or active, any case reports collected require further intensive investigation to determine what the hazard agent is and how, why, where and when the infection/contamination occurred. Epidemiological methods such as case control or cohort studies can be used to rapidly identify associations between exposures and outcomes. Control or prevention measures can then be designed and implemented.
 33. Special 'sentinel' surveillance systems may be established to give early indications of events that may in fact be a terrorist attack. These could include general practice sentinel systems, presentations to A&E departments, ambulance calls, pharmaceutical sales patterns and the like.
 34. Emergency departments are likely to be one of the earliest sites to respond to people affected by these agents and are an important component of the public health sentinel surveillance system. Prompt notification of the relevant health department will ensure the appropriate response will be initiated, particularly if mass casualties or a large scale incident has occurred.
 35. The Australasian College for Emergency Medicine has an adviser to assist with technical advice and preparedness for such events.
 36. Delays in determining the scope and magnitude of the exposure may result in illness and deaths that might have been avoided if a rapid response, based on accurate and timely surveillance data has been made.

COMMUNICATION

37. CBR events pose particular public health communication challenges due to:
 - lack of clarity as to the specific agent used;
 - potential for long lag times between incident and onset of symptoms;
 - lack of clarity as to who may be affected;
 - lack of access to expertise particularly if the agent is exotic;
 - potential for panic from an inadequately informed or misinformed public; and

- potential for panic amongst emergency service workers where they are inadequately informed.
- 38.** A communication strategy needs to be developed prior to the event and in particular should ensure a close relationship with the police as emergency coordinators. (See also Chapter 11, paragraphs 14–18.)
- 39.** The ability to communicate efficiently and effectively in languages other than English may be a significant component of any strategy.

PUBLIC HEALTH PREPAREDNESS

Planning

- 40.** Public health agencies should develop emergency response plans that are comprehensive. This includes:
- an all agency approach which involves the input of other agencies into the planning process to ensure consistency between emergency service agency approaches and avoid duplication or overlap; and
 - an all hazards approach which considers the emergency management issues associated with a range of potential hazards facing the community.
- 41.** Planning should encompass the development of systems to assist with the response to an emergency event and may include:
- development of data collection forms (see Annex A, Health Event Record);
 - acquisition of data analysis and mapping software;
 - provision of emergency hot lines;
 - provision of information in languages other than English in a timely manner;
 - up-to-date business and after hours contact details for appropriate personnel and other agencies;
 - access to additional resources including experienced personnel; and
 - access to specific expertise on health implications of CBR hazards.

Training/Education and Exercising

- 42.** Familiarisation and education of staff will be required as most will have no detailed knowledge about CBR hazards. The capacity to fulfil tasks should be assured and should be practiced.
- 43.** Public health professionals can in turn be involved in health and safety training for responders and education of defined populations at risk, provided educational materials are provided for their guidance and use.

Public Health Response

44. The ability for a public health agency to respond may depend on several factors. Readers are referred to the *Guidelines for the Control of Communicable Disease Outbreaks in Australia* produced by the Communicable Diseases Network of Australia and New Zealand (CDNANZ). Types of response could include the following:

- Announced threat with a specific agent prior to attack may enable:
 - more specific planning to be undertaken to respond in the event the threat is carried out;
 - specific expertise to be gathered to deal with specific agent;
 - stockpiling or administration of vaccines/antidotes;
 - distribution of specific information in relation to the agent to health care providers, responders and the public;
 - preparedness of health care establishments and emergency services to deal with an agent, manage the impact of the event on the organisation and minimise risk of secondary cases;
 - establishment of ‘hot lines’ for the public, health professionals and allied health care workers; and
 - initiation of advice on self-care and ‘buddy’ care to possible cases.
- Attack with a known or obvious CBR agent:
 - Unannounced attacks may be obvious but a covert biological or radiological attack may be difficult to detect and to characterise.
 - Rely on clinicians to recognise or consider the unusual and to report it.
 - Pathology laboratories must recognise and report unusual organisms or patterns of isolations and report them.
- Attack with an exotic CBR agent:
 - Rely on clinicians to recognise or consider the unusual and to report it.
 - Pathology laboratories must recognise and report unusual organisms or patterns of isolations and report them.
 - Identifying that these infections are an unusual event may be easier than instances when organisms that are endemic, or that are closely related to endemic agents, are used.
 - It may also be necessary to call for police assistance with the investigation and for help with the analysis of exposure data.

Surveillance Registers

- 45.** These are registers or surveillance systems of people exposed to or involved in the incident. The system may encompass:
- use for short and long-term follow-up studies of the health of these communities;
 - use as a passive system where people can voluntarily call to register their details;
 - use as an active system in which people are encouraged to have their details recorded;
 - recording of all emergency workers involved in an incident. These workers must have their roster details logged according to OHS requirements. These records should be available to the public health epidemiologist to enable long-term follow-up;
 - logging of all reported cases of exposure. Even if it is only perceived exposure, such cases should not be dismissed and consideration should be given to their access to information and counselling;
 - scrutiny of hospital admissions;
 - tracking of the demand for certain products through pharmacies; and
 - recording of 'hot line' calls.

Health Intelligence

- 46.** The development of meaningful health intelligence demands that information about infectious diseases collected by public health surveillance systems be routinely collated with current threat assessments and information on the potential for terrorist activities. This requires that liaison is established between police and public health officers as part of the planning process. This should ensure swift and open dialogue between those agencies in the event of an actual incident as well as raising the level of awareness of the public health services.

Other Epidemiological Aspects

- 47.** Other epidemiological aspects to note are:
- input into the formulation of risk analyses;
 - casualty estimates;
 - morbidity and mortality rates;
 - medical regulation planning; and

- exploration of the provisions in local, State/Territory health law and the Commonwealth Quarantine Act that could be used in a CBR event (eg for management of crowds of possibly contaminated people).
48. Public health input could be significant in mitigating the effects of an incident. For example in hoax situations, the terrorist could be deprived of the opportunity to induce an exaggerated response by civil authorities if rapid and accurate health support is available during the incident assessment process.
 49. If the threat is real, timely warning will enable the preparation of information on risks associated with particular agents and allow health resources to be alerted. It may be possible to stockpile vaccines/antidotes/antibiotics or to take prophylactic measures. This implies that feasible therapeutic regimens have been devised in advance and that the sources of these products in Australia are known.
 50. The Institute of Medicine notes the following:

‘The variable and often substantial delay between exposure to a biological agent and the onset of clinical signs and symptoms, as well as the possibility of person-to-person transmission, makes rapid and accurate diagnosis important, even if treatment of the earliest patients cannot be guided by laboratory findings. Protection of health care workers and treatment of delayed victims of the attack and secondary victims infected by an early victim will be much enhanced if exposure can be confirmed and treatment started prior to symptom onset.’
 51. Mechanisms must be found to allow the timely and secure briefing of clinicians both in private practice and in hospitals.

ENVIRONMENTAL HEALTH SERVICES

52. The variety of possible environmental impacts of a CBR incident would require environmental health experts, in company with representatives from the utilities and local government, to be involved with both the assessment and the recovery phases. See *also* your State/Territory HAZMAT plans.
53. Environmental health expertise would be valuable in relation to the provision of facilities for the maintenance of personal hygiene of the public and of emergency workers near the site of an incident. Supervision of food services and sanitation near the site would also be important functions. Uncontaminated and contaminated waste disposal would require cooperation with environmental protection authorities.

Food

54. Each State and Territory must have mechanisms in place to deal with food contamination issues. These include:
 - access to laboratory expertise to assist with identifying a contaminant;

- ability to identify product once contamination is suspected, including mobilisation of resources to find product;
- ability to alert consumers and food proprietors to any contaminated product;
- ability to recall product from the market place;
- mechanisms for the supervised disposal of contaminated product; and
- procedures for dealing with suspected sabotage incidents.

Water

- 55.** Each State and Territory must have mechanisms in place to deal with water contamination issues. These include:
- access to laboratory expertise to assist with identifying a contaminant;
 - ability to close water supplies where public health is at significant risk;
 - ability to access alternative supplies of water for communities; and
 - access to expertise to assess supply systems for the purposes of restoring supply.

Hygiene and Sanitation

- 56.** Appropriate messages regarding hygiene and sanitation may need to be distributed. This may include both reinforcing messages to the public and specifically to the emergency services workers.

Waste Disposal

- 57.** Each State and Territory must have mechanisms in place to deal with waste disposal issues. These include:
- access to environmental health and environment protection expertise regarding the collection, transport, storage and disposal/treatment of waste;
 - ability to collect and transport waste of different types (liquid, solid, mix etc);
 - ability to store waste of differing types awaiting transport, treatment and disposal;
 - ability to treat and/or dispose of waste;
 - mechanisms for recording volumes and types of waste, resources and staff involved, and treatment method and/or disposal location; and

- mechanisms to treat waste receptacles, collection/transport vehicles, storage sites, treatment facilities and disposal sites prior to return to normal use.

Vector Control

- 58.** Each State and Territory must have mechanisms in place to deal with vector-borne disease threats. These include:
- access to technical expertise (medical entomologists, virologists etc) to identify the vector and/or disease agent and advise on risk and possible control measures;
 - access to high level quarantine/containment facilities to work on the vector/agent, if required;
 - ability to rapidly alert the public of the threat and appropriate personal protection measures;
 - ability to conduct broad-scale vector control actions; and
 - ability to conduct vector/agent surveillance.

Disposal of Bodies

- 59.** Prior consideration must be given to the disposal or medium to long-term storage of bodies that may require further pathological testing or may be highly contaminated.
- 60. *Storage***—Interim storage facilities should be considered including the utilisation of large refrigerated or freezing facilities.
- 61. *Burial***—Provision of mass burial with the ability to identify specific graves should be planned. Consideration should also be given to identifying the circumstances under which cremation is appropriate or preferred.
- 62.** *See also Chapter 10—Forensic Issues.*

Annex:

- A. Health Event Record

HEALTH EVENT RECORD

[Please use BLOCK LETTERS for name and address]

Family name:		First name:	
Address:		Postcode:	
Telephone: ()		Sex: Male <input type="checkbox"/> Female <input type="checkbox"/>	
Age:	Occupation:		
Details of environmental accident:			
Date and time of incident: / /		AM/PM	
Your location at time of incident:			
Symptoms thought to be caused by incident:			
Date and time symptoms began: / /		AM/PM	
Did you seek medical advice? Yes <input type="checkbox"/> No <input type="checkbox"/>			
If so, doctor's name:			
Doctor's telephone:			
Doctor's suburb:			
CONSENT CLAUSE:			
Please read the following, and sign if you are in agreement:			
I consent to my doctor releasing further medical information related to this incident to officers of the State/Territory Health Department. I understand that the personal particulars of any such information will remain confidential. I understand that my medical management remains in the hands of my doctor.			
Signed:		Date:	
OFFICE USE ONLY			
Agency (for phone notifications):			
Epi-info record number:			
Follow-up information/comments:			

HEALTH EVENT RECORD

WHAT IS A HEALTH EVENT RECORD?

Health Event Records are voluntary records of the names, addresses and medical symptoms of people who think that their health may have been affected by an environmental incident.

WHAT IS AN ENVIRONMENTAL INCIDENT?

An environmental incident is an incident in which pollution of the environment occurs which might have the potential to cause illness or injury to people. Examples of this might include: fires, chemical spills, sewerage leakage or the unsafe dumping of waste materials.

WHAT SHOULD I DO IF I THINK MY HEALTH HAS BEEN AFFECTED BY AN INCIDENT LIKE THIS?

Before anything else, you should seek medical advice from your doctor. This will ensure that you receive any necessary treatment, and that your symptoms are properly documented.

WHAT ARE HEALTH EVENT RECORDS FOR?

The information on this record will be used by the State/Territory Health Department to help determine if any action needs to be taken to protect or monitor the health of the public, and to prevent harmful incidents occurring in the future.

Please note:

- Completing this form is entirely voluntary - you are not obliged to complete any or all of it.
- Providing information on this form does not constitute proof that your health has been affected by an environmental incident.
- This form is not an application for compensation or medical treatment.

WHAT IS THE CONSENT CLAUSE?

One question on this form asks you to consent to your providing further medical information about your symptoms to the State/Territory Health Department.

Any personal particulars on the Health Event Record, or which are provided by your doctor with your consent, will be treated with strict confidentiality by the State/Territory Health Department.

After completion, please return this form, as soon as possible, to:

The Chief Health Officer
State/Territory Health Department
<insert address of State/Territory Health Department>
Tel: Fax:

CHAPTER 13

HEALTH CONTROL ISSUES

INTRODUCTION

1. The main emphasis of this manual has been on site activities and the hospital response to a CBR incident. This chapter is aimed principally at health controllers touching on issues not raised elsewhere and identifying areas that require further management development. Chapter 2, paragraph 41, Health Controller Information Requirements summarises the main points and should be read in conjunction with this chapter. None of the issues presented are covered in minute detail, as the background information is vast and much of the final management principles need to be addressed at the local level both within health and in concert with the other responding services.
2. Some of the issues may just be listed as they require consideration in normal planning or the final decisions (eg equipment and drug caches need to be discussed at the national level).

HEALTH CONTROL ISSUES IN EVACUATION

General

3. Evacuation planning is a community risk assessment examining, the source of risks, implications of their impact and possible mitigation action and is the basis for formulation of the main emergency management plan. The starting point for consideration of an evacuation plan is where the risk assessment has identified evacuation as a potentially appropriate risk management strategy.
4. The management of the evacuation process is itself a complex task ranging from the warning, through sheltering and protection, actual evacuation, movement of the population safely, relocation to another site and its management, site clean up and then the subsequent return of the population to their homes and places of work and play. Coupled with the above are the psychosocial issues, generated by the unexpected event in relation to self and family preservation and protection of personal property.
5. As background to these issues in the first instance, readers are referred to:
 - *Evacuation Planning*, Manual 1, Volume 2, Part III—Australian Emergency Manuals Series (AEMS), EMA 1998;
 - *Safe and Healthy Mass Gatherings*, Manual 2, Volume 2, Part III—AEMS, EMA 1999, especially its sections on mass gathering behaviour;
 - Urban Search and Rescue, (Management)—AEMS (under development);
 - other relevant AEMS titles (see pages iii and iv); and

- Domestic Fallout Shelter Guide, Natural Disasters Organisation, 1989.

EVACUATION PLANNING PRINCIPLES

6. The principles which should be observed in evacuation planning are:
- determination of legal or other authority to evacuate;
 - establishment of a management structure;
 - clear definition of roles and responsibilities;
 - development of appropriate and flexible plans;
 - effective warning and information system;
 - assurance of movement capability;
 - establishment and maintenance of confidence and cooperation of the affected community;
 - appropriate welfare provision throughout all stages; and
 - exercise of developed plans.

EVACUATION OPTIONS

Types of Evacuation

7. For the purpose of planning, all evacuations may be considered to be one of two generic types:
- **Immediate Evacuation**—An evacuation resulting from a hazard impact, that forces immediate action, thereby allowing little or no warning and limited preparation time. Hazardous materials accidents/incidents, air crash, wildfire or earthquake are examples of events that may require immediate action.
 - **Pre-warned Evacuation**—An evacuation resulting from an event that provides adequate warning and does not unduly limit preparation time. Examples of this type of event may include flood, cyclone and storm surge.

In both cases, using the evacuation planning principles listed above is essential

Alternative to Evacuation

8. Although evacuation is considered an important element of emergency response that may be effective in many situations, there will be occasions when it may be assessed that people would be safer to stay and shelter in place. Depending on the nature of the hazard, measures such as closing windows, isolation of air conditioning systems and listening to radio and/or TV to receive information can be taken to reduce vulnerability.

THE EVACUATION PROCESS

9. The evacuation process consists of the following five stages:
 - Decision to evacuate.
 - Warning.
 - Withdrawal.
 - Shelter.
 - Return.
10. Detailed planning consideration for these stages are to be found in Chapters 4 – 8 of AEMS Part III, Volume 2, Manual 1—*Evacuation Planning*. This Manual deals with more specific health-related issues.

HEALTH-RELATED ISSUES

11. Planners and coordinators are referred to the article, 'Protecting Civilian Populations During Chemical Agent Emergencies' by George O. Rogers et al, which discusses the protective action evaluator for chemical emergencies (PAECE). This was developed for the US Army and the Federal Emergency Management Agency's Chemical Stockpile Emergency Planning Program to evaluate the extent to which alternative protective measures are likely to reduce exposure.
12. Listed below are some of the more important health issues discussed:
 - Evacuation is the preferred alternative for most people in an incident, where time permits.
 - In-place sheltering is preferred when the time to respond is very limited. This type of sheltering is ideal if the facility is pressurised, however, if not then consideration must be given to rescue of those sheltering after the passing of the threat. Buildings and other forms of in-place shelters eg cars, if not pressurised can act as concentrators of the substance being sheltered from (see below).
 - Respiratory protection measures may be used to significantly reduce exposure, however, leakage around 'standard or one size fits all' respiratory devices remains a major technical factor in the use of

respiratory devices to protect the general population. Generally respiratory protection is most appropriately used in conjunction with either evacuation or reduced infiltration, in-place shelters.

- No protective action can be completely effective for terrorist acts of the sudden release variety, owing to the potential for exposure before implementation of protection.
- Evacuation is a complex social process involving a multiplicity of decisions at the individual and/or family level. Some of the questions raised are; whether to evacuate, when to evacuate, what to take, how to travel, route of travel, where to go and when to return. Thus communication becomes vital for the decision making process.
- In considering evacuation a realistic time frame must be kept in mind.
- Evacuation is not always an option for an unannounced release as the process would involve exposure to the substance. On the other hand an attempt to evacuate in a situation involving extortion may precipitate agent release.
- Evacuation of people within 1 km in response to sudden release is not usually achievable and within 2 km, unlikely to be effective except in an extortion incident. Beyond 2 km, depending on meteorological conditions evacuation can usually be achieved. That is the faster the wind speed the greater the mixing and thus dilution or at slower wind speeds the more time available.
- In-place shelter relies on the reduction of air exchange between the toxic environment and the interior of the shelter. US studies on dwellings show air exchange rates of between 0.5 and 1.5 per hour. The rates are related to wind speed, orientation to the wind, structural characteristics and the temperature difference between the indoor and outdoor environments. The problem here is that exposure continues (at a lower level) and the shelter will need evacuation after the plume has moved on. This may require the use of respiratory and body protection for the evacuees.
- Under certain conditions in-place shelters may continue to accumulate the agent and thus be incapacitating or lethal to those inside. Thus those exposed to releases, exceeding 5 mg-min/m³ or where the substance is unknown or of long duration should be evacuated if possible. Notwithstanding this after passing of the plume this group will require assessment and their protective facilities decontaminated.
- In-place shelters provide protection against percutaneous and aerosols exposure. However, complete protection for people within 1 km of a release cannot be fully achieved without extremely rapid implementation and very low (or zero) exchange rates.
- Enhancing of the shelter by taping and sealing of an interior room can provide optimal short-term protection in a non-pressurised facility. (See Chapter 13, Annexes A and B for suggested requirements).

- Consideration must be given to the impact of potential contamination of the water supply.
- Consideration must be given to the impact of potential contamination of the sewerage system.
- A protective action strategy should be developed for health care facilities that may not be able to respond in time if in close proximity to the release.

HOSPITAL OPERATIONS GROUP

13. Health control should establish a liaison group with the treating facilities, made up of an emergency physician, an emergency nurse and or an ambulance officer.

Duties

14. The Hospital Operations Group duties are as follows:
 - Serve as liaison via the Health controller between the HAZMAT Health Team (HHT) and local medical facilities receiving patients.
 - Assist the Health controller with communicating vital information to the receiving hospital/s.
 - Work with the Health controller to provide the medical community via phone, facsimile, or computer the needed patient care information for the agent(s) involved.
 - Implement a system of patient tracking in concert with the on-scene Health service personnel and facilities receiving patients.
 - Identify the antidote needs of each facility and assist them in obtaining the needed items from the team cache, regional cache, government agencies, or vendors.
 - When requested, serve as clinical consultants to the medical staff at each medical facility providing advice on patient care, personnel safety, or facility protection.
15. Depending on the incident complexity a similar person/group may be set up at the site or receiving facility to assist the field or local commander. If deployed to the field then each person will follow the guidelines regarding personal safety as other team members.

MATERIAL MANAGEMENT AND SUPPLY (LOGISTICS OFFICER)

16. States and Territories should have at least one centrally-nominated logistics officer and one at each location where equipment caches are kept if at Ambulance depot/s or hospital/s.
17. This person is responsible for managing the equipment of the field team/s and any hospital deployment.

Duties

18. The Logistics Officer's duties include:
 - ensuring maintenance of the equipment cache in a state of readiness for immediate deployment;
 - ensuring this cache gets to the designated mobilisation point or incident location;
 - ensuring procurement of non-cache items during the mobilisation phase or on site as appropriate;
 - assisting with the distribution of the needed medical equipment and pharmaceuticals from designated local and regional facilities; and
 - maintaining appropriate records and reports.

Operational Checklist

19. The Logistics Officer should establish an operational checklist in order to:
 - identify cache maintenance problems and recommends corrective action to the health controller;
 - maintain a current computerised inventory listing of all equipment and supplies;
 - ensure that all equipment testing is current and in compliance with appropriate local, State/Territory, and national guidelines; and
 - ensure equipment cache inventory is in a constant state of readiness for deployment.

On-Site Duties

20. If the Logistics Officer is deployed to the site, additional duties include:
 - ensuring personal protective equipment is in order;
 - ensuring appropriate transport for the cache;
 - establishing cache set-up for use;
 - coordinating distribution of cache to various sectors;

- keeping records relating to various items of equipment and supplies being issued to HHT personnel;
- carrying out tactical assignments as directed;
- ensuring the use of all safety practices and procedures;
- keeping the Central Logistics Officer apprised of any equipment deficiencies or malfunctions;
- providing equipment repair and maintenance;
- ensuring replacement is briefed fully in relation to on-going operations when being relieved at work cycle rotations; and
- upon completion of incident site activities:
 - ensuring that all equipment is returned to the cache;
 - assisting with the breakdown and policing of the HHT operational area;
 - ensuring all equipment is properly decontaminated before returning to the cache;
 - ensuring proper disposal of contaminated items that cannot be decontaminated; and
 - coordinating the reloading of the equipment cache for return home.

Post-Incident

21. After the Incident the Logistics Officer should:

- report any ill or unusual feelings or sicknesses that may be attributable to exposure at the incident;
- participate in the HHT incident de-briefing;
- ensure that all consumables have been replenished;
- ensure needed repairs and preventive maintenance are done on all items prior to being returned to the cache for the next deployment;
- identify and document all operational losses or expendables for subsequent replacement or repair (if repairable);
- submit personal notes to the Central Logistics Officer for inclusion in the post-incident report.

22. The Logistics Officer is responsible for managing the equipment cache for the HHT during incident operations. The Logistics Officer reports directly to the HHT field commander.

FIELD LOGISTICS OFFICER

- 23.** The Field Logistics Officer is responsible for managing the equipment cache for the HHT during incident operations. The Field Logistics Officer reports directly to the HHT field commander.

Duties

- 24.** The Field Logistics Officer should:
- ensure the equipment caches in an appropriate state of readiness for immediate deployment;
 - ensure cache gets to designated mobilisation point or incident location;
 - supervise the packaging, transport, distribution, and maintenance of the task force equipment cache during mission assignments;
 - coordinate with the ADF and civilian transport officials for all cache logistics;
 - procure non-cache items, either during the mobilisation phase or on-site, as appropriate;
 - obtain needed medical equipment and pharmaceuticals from designated local and regional facilities;
 - ensure the security and accountability of all components of the task force equipment cache;
 - maintain appropriate records and reports; and
 - perform additional tasks or duties as assigned during an incident.

EQUIPMENT, STORAGE AND UTILISATION

General

- 25.** The organisation and management of a comprehensive equipment cache must address the needs of on-scene operations and promote efficient packaging, handling, and transportation both to and from the disaster location.
- 26.** Efficient packaging, handling and transportation of cache tools, equipment and supplies are fundamental to meeting the time constraints of response to a CBR incident.
- 27.** In order to meet a 60 to 90 minute response time, all tools, equipment, and supplies should be pre-packaged into a cache.
- 28.** Packaging for the HHT cache should be of modular design to provide for multiple transport options for handling the equipment.

29. All State and Territory equipment shall adhere to a HHT inventory standards. This standardisation will take into account ADF guidelines and promote more efficient management and transportation of any or all HHT caches during multiple team responses.

Personal

30. Each HHT member is issued a kit of standard inventory equipment, which will be readily available at all times.
31. This kit will consist of personal protective equipment (PPE) (respirator, suit, gloves, boots, glasses, helmet), team disaster suit, auto-injectors (if indicated) personal decontamination kit, monitoring devices (such as paper or badges) and equipment bag.
32. It is each members responsibility to ensure that all personal-issue equipment is checked regularly (ie monthly) and to report to the Logistics Officer any deficiencies.

Medical Equipment

33. A complete inventory of medical equipment can be found in the equipment/cache listing in State and Territory CBR sub plans and a copy is kept with the equipment.

Pharmaceuticals

34. A complete inventory of pharmaceuticals can be found in the State or Territory CBR sub-plan and with the kit.

Cache Packaging

35. The following is a recommended cache division and colour-code scheme.

ELEMENT	COLOUR CODE
PERSONAL PROTECTIVE EQUIPMENT	Red
MEDICAL	Blue
DETECTION/SAMPLING	Yellow
LOGISTIC/COMMUNICATIONS	Green
DECONTAMINATION	White

36. The ability to rapidly identify and package supplies and equipment is necessary to efficiently deploy and track cache items. This process is facilitated by stencilling the following information on the lid and two adjacent sides of each container:

- Inventory number of container.
- Unit name.
- Contents.

- Colour-coded stencil of the equipment category.
- 37.** In order to ensure security and avoid unnecessary damage to cache items, all containers should be:
- constructed of high-impact material;
 - weatherproofed;
 - provided with handles or retractable handles;
 - provided with stackable corners;
 - provided with fasteners to prevent accidental opening;
 - not more than 68 kg (gross weight of container and contents);
 - without rolling stock (vehicles); and
 - easy to decontaminate.
- 38.** The packaging of equipment into containers should be done not only for ease of handling during transport, but also with operational and OHS considerations in mind.

Cache Ground Movement and Deployment

- 39.** The Logistics Officer must plan for ground transportation requirements according to the cubic space and gross weight of the entire cache. Ground transportation during mobilisation and while on site will require manual handling and loose loading of cache containers. Adhering to the container weight and size limitations will ensure overall manageability of the cache and is of paramount importance.
- 40.** The Logistics Officer of the organisation housing the equipment cache is responsible for the assembly, management, and movement of the cache from its home jurisdiction to the staging area (or other area as directed by the HHT commander) during mobilisation. This requirement should be fully defined, pre-planned, and exercised prior to any actual mobilisation. Processes should be in place for:
- assembling and packaging all cache tools, equipment, and supplies (should the items not be maintained as a 'stand alone' cache);
 - identifying, procuring, and packaging short shelf-life items (eg batteries, fuels, drugs); and
 - generating an inventory of all cache items.

Cache Supplementation

- 41.** Equipment may sometimes need to be replenished/replaced during on-site field operations (particularly extended operations). This will be arranged through Health control as it may involve ordering equipment from a supplier or obtaining equipment from a local Health care facility.
- 42.** In a large-scale CBR incident, it is likely that provisions will have to be made to restock local hospitals and medical facilities with critical antidotes and other pharmaceuticals. This may require contacting a pharmaceutical manufacturer/

supplier for a special delivery or coordinating with the ADF to obtain access to their supplies.

43. Agreements should be in place with pharmaceutical manufacturers/ suppliers to obtain products rapidly.

Air Transport

44. Air transport may be provided by civilian agencies or in some circumstances by the ADF. No flammable liquids can be transported by air. Therefore fuel tanks must be emptied prior to departure.
45. Civilian aircraft may have to be manually loaded in lower cargo holds. ADF aircraft will require palletisation of all cache containers and personal equipment.
46. Team Logistics Officers should identify the weight and volume of all containers, equipment, and supplies in the cache prior to mobilisation. Consideration must be given to supplies that must be shipped in pressurised atmospheres.

Accountability/Resources Tracking

47. The HHT must rely on the availability and readiness of equipment to support on-scene operations. A comprehensive property accountability system is essential for ensuring that equipment readiness is maintained. A system for accountability must be developed before any mobilisation to ensure cache readiness. On-going maintenance and exercise of the cache equipment must be ensured for operational readiness between mobilisations. As such, there must be an organised system of equipment inventory, maintenance, and routine operation to ensure that the cache is ready for immediate response.
48. The Logistics Officer position has primary responsibility for property accountability and resource tracking during the mobilisation, incident operation, and demobilisation phases. This position tracks, distributes, maintains, and accounts for all equipment for the team.

SPECIAL EQUIPMENT, SUPPLIES AND CONSIDERATIONS

49. No attempt has been made to address the very special issues listed below although current planning is addressing a requirement of 1000 seriously affected people for each HHT response capability. The detail of the issues raised below is addressed in local plans:
 - Ventilator capacity and alternatives to respiratory support including availability of loan units.
 - Drug caches and the supply and resupply of antibiotics, vaccines, antidotes and appropriate other pharmaceuticals.
 - Equipment requirements for decontamination at health care facilities.
 - Alternative modes of transport to protect our ambulances if the agent were particularly difficult to remove from the vehicles.

Annexes:

- A. Room Sealing
- B. Room Equipment

ROOM SEALING

1. Principles for choosing a room for sealing are that it should be:
 - an internal room;
 - a large room;
 - a room with a minimum number of openings and windows; and
 - adjacent to toilet and water supply.

2. Materials for sealing a room are:
 - rolls of wide adhesive sealing tape;
 - an applicator wheel for applying the tape quickly;
 - sheets of thick plastic and polythene;
 - floor cloths; and
 - a bucket and a bottle of household bleach to soak cloths used to seal doors.

ROOM EQUIPMENT

Items to take into the room chosen.

PROTECTIVE EQUIPMENT

- Any personal protective kits (if available).
- Water proof clothing including raincoats and shoes.

WATER

- At least one litre per person preferably in a sealed glass bottle.

LIGHTING EQUIPMENT

- Emergency light.
- Flashlight and spare batteries.
- Candles and matches.

COMMUNICATION EQUIPMENT

- Battery operated transistor radio.
- Television set.
- Telephone.

FIRST AID EQUIPMENT

- First aid kit (including instructions).
- Fire extinguisher (if available).
- Scissors.

MATERIALS TO OCCUPY CHILDREN AND TO PASS THE TIME

- Toys.
- Games.
- Books.

CHAPTER 14

CHARACTERISTICS OF NUCLEAR WEAPONS

GENERAL

Yield

1. The power of a nuclear detonation is on a much greater scale to that produced by high explosive. The yield of a nuclear weapon is expressed in terms of the equivalent energy released by the detonation of TNT:

Types of Burst

2. The characteristics of a nuclear explosion vary with the location of the point of burst. Detonations can therefore be classified by the position of the fireball in relation to the Earth's surface:
 - exo-atmospheric, or outside the atmosphere (30+kms); and
 - endo-atmospheric airburst, surface, sub-surface.

SUMMARY OF CHARACTERISTICS

3. The characteristics of a nuclear explosion are:
 - an intense light flash;
 - a fireball;
 - a thermal heat pulse;
 - a pressure wave giving rise to blast and shock-wave;
 - radiation in the form of:
 - an initial radiation pulse;
 - residual radiation from neutron-induced activity in the ground and the 'fall-out' of radioactive material;
 - transient radiation effects on electronics;
 - electromagnetic phenomena; and
 - a prominent cloud.

Light Effects

4. **Flash**—The intense flash from a nuclear burst can affect vision well beyond the range at which heat burns occur.
5. **Dazzle**—Dazzle (sometimes called ‘flash blindness’) is a temporary loss of vision resulting from the brightness of the visible burst. As a guide, in daylight those facing the burst are likely to be dazzled for about two minutes. At night dazzle will affect those facing the burst for about ten minutes and those facing away for about three minutes. It is not possible to predict the numbers of personnel who will be dazzled at various ranges because the results will depend on:
 - individual eye characteristics which will vary in terms of blink reflex time and sensitivity;
 - the degree of eye dark adaption which will depend on the darkness of the night;
 - atmospheric conditions which will affect the degree of light scatter and absorption; and
 - the degree of cover an individual may have at the time.
6. **Eye Damage**—Retinal burns occur when the eye lens focuses the fireball image onto the retina. Shallow burns heal completely. Deep burns lead to permanent blind spots. However, sight is not normally lost completely. It has been estimated that only two per cent to three per cent of those dazzled will suffer retinal burns and only 0.1per cent will suffer permanent visual field effects in one or both eyes.

Heat or Thermal Effects

7. **Heat**—This is a principal casualty incapacitating effect. It is likely that some 50 per cent of nuclear weapon casualties will suffer burns, especially with larger weapon yields. Burns are likely to result:
 - to exposed skin unprotected from the thermal pulse; and
 - from charred or burnt clothing and/or local fires.
8. **Heat Effects on Materials**—The thermal pulse delivers a large quantity of heat in a very short time. Damage will be related to the amount of heat absorbed: pale coloured materials that tend to reflect heat are likely to be the least damaged. Heat will not affect vehicles, equipment and supplies unless they are very near to Ground Zero (GZ). Fires started by the ignition of paper, fabric, netting and vegetation are likely to be a serious risk.

Blast and Shock Effects

9. The pressure wave from a nuclear explosion is transmitted as a blast wave in the air and as a shock wave through the ground.
10. **Pressure Wave Components**—The pressure front passes through the air as a wave. A high pressure peak is followed by a low pressure trough and an outwards flow of air by an inward flow of air as follows:
 - *Static Overpressure*—The positive phase when the peak pressure arrives at a given point;
 - *Underpressure*—The negative phase where the peak overpressure has passed leaving a relatively low pressure zone behind it and the wind reverses direction; and
 - *Dynamic Pressure*—Behind the wave front very strong vortex winds blow down, tear away and carry off obstructions as the rush of air attempts to restore the pressure balance.
11. **Effect on Personnel**—The human body has some resistance to the blast overpressure. The main danger is from indirect effects, such as:
 - collapse of buildings and the overturning of vehicles;
 - impact of flying debris; and
 - injuries caused by being picked up and flung by the wind.
12. **Resource Damage**—The damage suffered by equipment and installations is likely to include:
 - antennae broken off, cables stretched and severed;
 - vehicles, aircraft and equipment overturned;
 - buildings crushed or caused to collapse by the pressure changes;
 - earthworks collapsed by the ground shock wave; and
 - supplies, and equipment picked up and dispersed by the winds.
13. **Terrain Effects**—The most significant terrain effect on operations will be the blowdown of structures and trees. Pressure waves follow ground undulations, so terrain affords little protection from blast and shock.

Nuclear Radiation

14. **Phases of Radiation**—Nuclear radiation has no counterpart in a conventional explosion. Gamma rays and neutrons are the most important but beta and some alpha particles may be emitted by fallout. Radiation following a nuclear explosion has two phases:
 - *Initial Radiation*—This is defined as that emitted during the first minute following detonation. It consists of gamma radiation and neutrons produced during fission or fusion; both are penetrating radiations and require considerable shielding to reduce their effects.
 - *Residual Radiation*—This is that which remains after one minute, post-detonation. It essentially is comprised of neutron induced activity and the ‘fallout’ of radioactive fission products.
15. **Neutron-Induced Activity**—The neutrons liberated in the fission process can induce artificial radioactivity in the air (especially nitrogen) and in material sucked into the fireball from the surface of the earth. The artificial radioactive substances so formed emit gamma rays and beta particles and add to the fission products in fallout and in the vicinity of ground zero.
16. **Fallout**—This consists of a large number of different radioactive isotopes mainly originating from the fission process but including some neutron-induced activity. In an air burst these isotopes form small (0.01 to 20 micron diameter) particles that get carried in the nuclear cloud to high altitudes and are deposited slowly over very large areas after significant radioactive decay has occurred. Rain can however bring down higher local concentrations as ‘rainout’. With surface or sub-surface bursts, material from the earth’s surface is sucked up into the fireball and radioactive particles condense onto this material to form much larger (1 micron to several millimetres in diameter) particles which return to earth much faster than in an air burst. The area of principal concern is downwind, although, closer to ground zero beneath the cloud, deposition upwind can occur.
17. **Human Effects**—All forms of ionising radiation can be harmful to humans. Gamma rays cause direct ionisation within the cells of the body. Neutrons also cause ionisation but indirectly by various preliminary interactions. Beta particles have a short range in tissue and can only cause ionisation inside cells if they can reach them. Thus fallout on the skin can emit beta particles that can cause local ‘beta burns’, or inhaling or swallowing fallout can result in internal beta irradiation of the body. Dividing cells are more damaged than resting cells and so the bone marrow where the blood cells are produced and the lining cells of the gastro-intestinal tract are the most susceptible to damage.
18. **Radiation Measurement**—Radiation dose measured in centigrays (cGy) which is equivalent to and replaces the rad.

RADIATION SYMPTOMS

Major Damage Phases

19. The symptoms of major radiation damage in personnel are as follows:
- **Initial Symptoms**—(0.5–6 hrs.) Nausea, vomiting, loss of appetite and general malaise with a dose dependent onset.
 - **Symptom-Free Period**—(3 hrs to 3 wks) Again dose dependent, averaging from perhaps 12 to 48 hours after exposure
 - **Second Phase of Symptoms**—(1–2 days to 3 wks) In all but the non life-threatening dose range, consisting of further nausea, vomiting, diarrhoea, fever, haemorrhages, much reduced resistance to infection, depending on the dose received. Recovery in a further three to four weeks or death are the possible outcomes of the second phase.

Radiation Sickness

20. In practical terms radiation doses are cumulative in effect, however, radiation dose figures should only be regarded as a guide. The damage and symptoms, depend on:
- the dose;
 - the rate of receipt each time;
 - the interval between exposures;
 - individual variation.

Dosage Effects

21. The effects of increasing radiation dosage on humans are as follows:
- **Below 150 cGys**—Minimal initial symptoms only may be expected in a minority of those exposed. There are however, some increased long-term cancer risks;
 - **Between 150 and 450 cGys**—A first stage with onset decreasing from perhaps four to six hours to less than 1 hour with increasing dose over this range and lasting 12 to 24 hours, followed by a 20 down to perhaps 10 days symptom free period. Deaths would approach 50 per cent at the top of the range;
 - **Between 450 and 800 cGys**—After an initial period from 30 to 60 minutes after exposure lasting perhaps 48 hours and a symptom-free stage of 10 days down to two or three days; deaths would reach 100 per cent by the top of the range; and
 - **Over 800 cGys**—Incapacitation would commence soon after exposure and lead to death within the next few days.

TRANSIENT RADIATION EFFECTS ON ELECTRONICS (TREE)

22. The initial radiation pulse includes gamma rays and a neutron flux. The significant effects of these on electronics are as follows:
- **Gamma Rays**—The pulse of high-energy gamma rays lasts for a fraction of a second. It may destroy semi-conductor devices by induced overloading.
 - **Neutron Flux**—The neutron flux accompanying the gamma rays can affect semi-conductors by changing their electrical characteristics such that performance is permanently or temporarily altered.

TREE Problems

23. With large nuclear weapons the effective range of TREE is probably exceeded by the travel distance of heat and blast effects at damaging levels. However, with low-yield weapons, especially those with enhanced radiation warheads, TREE may be a significant problem as:
- all electronic components are at risk. The degree depends on the magnitude of the radiation pulse and the amount of nuclear hardening built into the equipment; and
 - the radiation pulse is transient but the effects on electronics may be permanent resulting in complete or partial degradation of the performance of electronic components.

CHAPTER 15

NUCLEAR WEAPONS—EFFECTS

GENERAL

1. This chapter covers the clinical aspects of the various health problems which may be seen in modern warfare as a result of the use of nuclear weapons. Blast, thermal, and radiation injuries are discussed.

PHYSICAL EFFECTS

Blast

2. **Injuries**—The types of blast injuries caused by nuclear weapons are more varied than those caused by conventional weapons and are the result of two basic mechanisms, either the direct action of the blast wave overpressure or the indirect action of flying debris or violent displacement of individuals against other objects. In addition, the blast injuries caused by nuclear weapons will frequently be complicated by associated thermal and/or radiation injuries. Finally, the number of casualties produced at any one time in a given area will be very much greater for nuclear weapons than for conventional weapons.
3. **Diagnosis**—The diagnosis of blast injuries is generally not difficult unless there is unrecognised internal injury with slow haemorrhage. As noted, missile injuries will predominate. About half of the patients seen will have wounds of their extremities. The thorax, abdomen, and head will be involved about equally. Missile injuries of the thorax, neck and the head will be responsible for a large percentage of deaths because these types of injuries have a high probability of immediate fatality. The missile injuries caused by nuclear weapons will, in general, be of the low velocity type, and surprisingly severe injuries may be survived since extensive soft tissue cavitation would not be a factor. These injuries can occur with or without perforating wounds of the abdomen or the chest.

Thermal

4. **Injuries**—In a nuclear incident, burns could become the most frequent injury seen. Because of the complexity of burn treatment and the increased logistical requirements associated with the management of burns they will constitute the most difficult problem faced by the health service.
5. **Diagnosis**—Certain factors are of prime importance in the early evaluation of burns because of their relation to overall prognosis. These include:
 - area of the burn (expressed in percentage of body surface involved);
 - involvement of critical organs (ie head and neck, respiratory tract, genitalia, hands, and feet);

- depth of burn; superficial (first or second degree), or deep (second degree) and full thickness (third degree).
6. **Area of Burn**—The most accurate way to estimate the amount of tissue injury following a burn is to measure the extent of the body surface burned. However, direct measurement is not generally possible or necessary, and a short cut method of estimating the percent of the body surface involved can be very useful. The ‘Rule of Nines’ method is a simple and reasonably reliable guide in which the various parts of the body are divided into surface areas of nine per cent each (or multiples of 9 per cent) as outlined in Table 1.
 7. As the percent of the surface burned increases, morbidity and the probability of mortality increases sharply. Burns which cover 20 per cent or more of the body surface can be fatal without treatment. Even with treatment, mortality from extensive burns will be high, particularly in the very young or the aged. Young healthy soldiers who have uncomplicated burns may survive even extensive involvement with proper care.
 8. Determination of the percent of the body surface involved will aid in planning resuscitative treatment and estimating fluid requirements during the first 48 hours after the burn injury. Patients with severe burns will suffer quite extensive fluid and electrolyte losses, resulting in severe hypovolemic shock, requiring aggressive fluid replacement therapy as early as possible. Delay in this resuscitation therapy increases morbidity and the risk of mortality. When large numbers of patients must be handled simultaneously, procedures for resuscitation must be standardised and as simple as possible. An outline of a resuscitative program is given in the treatment section.

Anatomic Surface	% Of Body Surface
Head and neck	9
Anterior trunk	18 (2 x 9)
Posterior trunk	18 (2 x 9)
Upper limbs	18 (9 each)
Lower limbs	36(18 each)
Genitalia and perineum	1
Total surface area	100

Table 1: Rule of Nines for Estimating Extent of Body Surface Burned

9. **Burns to Critical Systems**—When certain organ systems are involved, the clinical effects of burns can be quite serious in spite of the fact that only a small fraction of the body is involved. Details are as follows:
 - *Head and Neck*—Burns of the face can be serious problems, even if the eyes are not involved. Burns of the head frequently are complicated by severe oedema, which can result in respiratory obstruction. This can be quite serious when the inhalation of hot gases has occurred. It may be necessary to do tracheostomies on many of these patients.
 - *Respiratory Tract*—When hot gases are inhaled, severe burns to the respiratory tract may be sustained. These injuries have a high probability

of mortality if the burns extend deep into the alveoli. These patients are very fragile and may not tolerate early evacuation. Pulmonary oedema may develop abruptly, without warning and require vigorous ventilatory support. These injuries can be very difficult to manage.

- *Hands and Feet*—These can be very disabling and may require long hospitalisation for extensive surgical care even though they are not life threatening injuries. These patients may not be able to care for themselves, and as a result, will require extensive nursing care.

10. Depth of Burns—Burns are classified on the basis of the depth of the injury as follows:

- *Superficial or Partial Skin Thickness*—These are lesions in which the dermis is intact and only the epidermis is injured. When the injury is limited and only erythema occurs (such as in sunburn) these are usually called **first-degree burns**. If blistering is seen, the injuries are called **second-degree burns**. Superficial burns are usually painful but will heal readily by epithelization unless infection occurs. Infection can convert a typical second-degree, superficial burn into a deep or full-thickness burn which will not heal by epithelization but rather by scarring. Second-degree burns will be very common in nuclear incidents and may be the one most common injury seen.
- *Deep or Full Skin Thickness*—Injuries involving the full thickness of the skin which cannot heal by epithelization are call **third-degree burns**. Instead, these injuries heal by scarring, and as a result there may be contraction and loss of function, particularly if extremities are involved. Extensive **plastic surgery** may be required to prevent or limit loss of function. The areas of a burn which are third degree are usually painless, and this helps differentiate areas of third from second degree when both are present. The earlier the diagnosis of the degree of burn is made, the sooner reconstructive treatment with skin grafting can be started. In general, however, in nuclear incidents early skin grafting will rarely be possible.

Radiation

11. Radiation injury alone or in conjunction with other injuries or diseases will be common in a nuclear incident. Radiation injury can result from:

- a single exposure to radiation at the time of detonation;
- exposure to high levels of fallout radiation; or
- repeated exposures to both with complex patterns of recovery from an accumulation of radiation damage.

12. Irradiation of the whole body, or of major parts of the body, where absorbed doses are high and acquired over short periods of time, will result in acute radiation sickness. There are three characteristic syndromes which make up the typical clinical pattern of acute radiation sickness. There are the haematopoietic, gastrointestinal, and neuro-vascular syndromes which occur with increasing dose respectively.

13. The haematopoietic syndrome, or syndrome of bone marrow damage, occurs at lower doses than other syndromes and would be the most common form of radiation sickness seen in a nuclear incident. Manifestations of bone-marrow

damage are seen following doses of radiation in the low through mid-lethal range.

14. Gastro-intestinal tract damage begins to occur at doses above the mid-lethal range. As the probability of lethality becomes 100 per cent with higher doses, the gastrointestinal syndrome will predominate. This syndrome, which will also be common, develops from combined severe damage to bone marrow and the gastrointestinal tract.
15. The neurovascular syndrome is associated with absorbed doses in the supralethal range and would be seen quite rarely, since heat and blast effects would cause immediate lethality in most situations where the required very high radiation doses would be sustained.

CHAPTER 16

NUCLEAR INCIDENT MEDICAL MANAGEMENT

Acknowledgment and Appreciation

This chapter is almost a complete reproduction of the article published by Drs John L. Holmes and Paul D. Mark as a supplement to the September 1991 edition of *Emergency Medicine*. Part of the section is also taken from ADFP 713—*Health Aspects of Nuclear, Biological and Chemical Defence*.

The AMDCG wishes to express its sincere appreciation to the editors of *Emergency Medicine* for their kind permission in allowing its publication in this Manual.

RADIATION PHYSICS

1. The nucleus of an atom is made up of neutrons and protons. The surrounding electron cloud is described by quantum mechanics in terms of probability functions which define the likelihood of electrons occupying certain energy levels which are represented as 'shells' and 'sub-shells'.
2. An element is defined by its **Atomic Number** which is the number of protons in the nucleus with the **Mass Number** being the sum of the protons and neutrons. The atomic number is written as a subscript and the mass number as a superscript see example below. Isotopes are elements with the same number of protons but varying numbers of neutrons (ie same atomic number but varying mass numbers). In low atomic number elements the number of neutrons tends to equal the number of protons but with increasing atomic size the ratio of neutrons to protons increases. Because of their relative neutron excess, the nuclei of heavier isotopes may be relatively unstable. These are said to be radioactive and achieve a lower, more stable energy state by the radiation of mass-energy known as ionising radiation.



3. Ionising radiation comprises four basic types:
 - Alpha particles.
 - Beta particles.
 - Gamma rays and x-rays.
 - Neutrons.

These have different physical characteristics and biological effectiveness in causing tissue damage.

Alpha Particles

- Alpha particles are essentially helium nuclei ie two neutrons and two protons with two positive charges. They are produced during the decay of heavy radioactive elements.

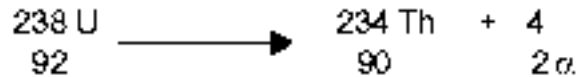

- Alpha particles lose energy to materials rapidly and only penetrate tissues to the thickness of the epidermis. Alpha emitting sources such as americium are therefore only a significant problem if they are ingested, inhaled or contaminate open wounds.

Beta Particles

- Beta particles have both the mass and negative electrical charge of electrons but are derived from within the nucleus. In this process, a neutron is converted to a proton and although the mass number of the nucleus thereby remains unchanged, its atomic number increases by one creating a new element.

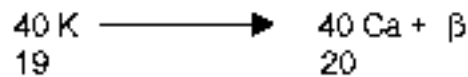

- Tissue penetration by most beta particles is only 1 – 2 mm. Beta radiation tends to produce burns which are not visible immediately after exposure.

Gamma Rays and X-Rays

- Gamma rays and x-rays are electromagnetic radiation (ie high-energy photons without mass) whose energies, wavelengths and frequencies overlap. They differ in their mode of production.
- Gamma rays are photons derived from within the atomic nuclei due to changes in nuclear energy states. They are often emitted following beta emission if daughter nuclei are in an energy state greater than the ground state.

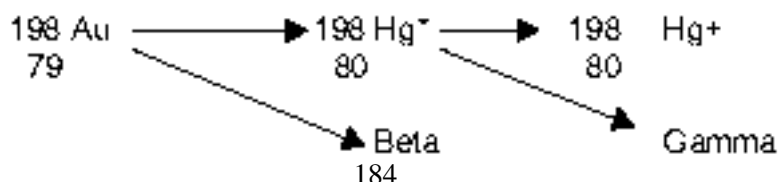

10. Gamma rays produced on earth have energies between 5 keV to about 4.8 MeV, though cosmic rays from outer space may have energies ranging up to 20 MeV or higher. Gamma rays can penetrate the body with a proportion of energy being given up as each successive layer of tissue is penetrated. Gamma rays are the major cause of the acute radiation syndrome.
11. Whereas gamma rays are produced from within the-nucleus, x-rays are photons derived extra-nuclearly in response to electron energy state transitions. X-rays are also produced in x-ray machines and linear accelerators for industry and medical diagnosis and therapy. In this case, x-rays result from the sudden energy loss experienced by electrically accelerated electrons when they interact with the electric field of atoms in the target material at which the electron beam is directed within the machine. Such targets are commonly copper or nickel for low-energy (around 10 keV) industrial and research x-ray analysis machines; molybdenum for low-energy mammography x-rays (around 18 keV); tungsten for most diagnostic x-ray machines (around 30 to 60 keV) and industrial radiography machines (up to 200 keV); with gold commonly being used for radiotherapy linear accelerator targets producing x-rays with energies between 4 and 20 MeV.
12. Like gamma rays, x-rays penetrate tissue; the higher their energy, the lower the rate at which they deposit ionising energy in the tissue through which they pass. This means that severe superficial burns are the most likely result of fingers being placed into the x-ray beam of an x-ray analysis machine because most the energy will be absorbed within 1 or 2 mm. Higher energies such as those from industrial radiography machines may also cause superficial burns but these will be accompanied by deeper tissue injury as well.

Neutrons

13. Neutrons are ejected during the fission of uranium-235 atoms in the core of a nuclear reactor. To sustain the nuclear chain reaction and hence power output of the reactor, it is necessary to capture one of the two or three neutrons produced per fission in the nucleus of an additional uranium-235 fuel atom to produce a further fission. It needs to be understood that the concentration of uranium-235 in the fuel of power reactors is well below that at which a nuclear explosion could occur. The worst accident may result in melting of the fuel. Nuclear weapons require virtually pure uranium-235 or plutonium-239 to produce an explosive rate of chain reaction.
14. Within a reactor such as HIFAR (High Flux Australian Reactor) at Lucas Heights, small aluminium cans containing target material are inserted into the centre of fuel rod clusters where there is a high flux density of free neutrons. Some of these neutrons are captured by the nuclei of the target atoms, increasing their mass number by one and hence making them radioactive. The predominant mode of decay of these radioactive isotopes is by emission of beta and gamma radiation. HIFAR is the source of many of the radioactive isotopes used widely throughout medicine and industry in Australia and neighbouring countries.

15. Neutrons are also produced from sealed radioactive sources such as americium/ beryllium (used in soil moisture meters and oil well logging) and californium-252 used for medical neutron therapy. It is also possible to produce them in electrical accelerating machines such as neutron generators and the high-energy accelerators used in research.
16. Within tissue, neutrons predominantly lose energy in collisions with protons in the nuclei of hydrogen atoms, in body water. The interaction results in ionisation within the tissue atoms so irradiated. Except at lethal levels the neutron flux is not sufficiently high to cause the tissue to become radioactive.

Range in Air	Range in Tissue	Hazard
Few cm	50 micron	Internal
Few metres	Few mm	External and internal
Many metres	Many cm	Mainly external
Many metres	Many cm	Mainly external
Many metres	Many cm	Mainly external

Table 1: Summary of Types of Ionising Radiation

UNITS OF MEASUREMENT IN RADIATION

17. SI units have replaced the traditional units used in the quantification of radiation and radioactivity. However, in some areas the older units remain in concurrent usage.

Electron Volt

18. The electron volt (eV) is defined as the amount of energy acquired by an electron passing through a potential difference of one volt. It requires 33–34 eV of energy to produce one ion pair in air. Electromagnetic radiations such as microwaves, infra-red rays, visible light and ultraviolet rays do not have sufficient photon energy to cause ionisation.

Activity

19. Activity is the average number of nuclear disintegrations per second, and is a measure of the amount of radioactive material present. The classical unit is the **curie** (Ci) which was originally defined in terms of the activity of 1 gram of radium. The SI unit is the **becquerel** (Bq) which equals one nuclear disintegration per second (dps).

$$1 \text{ Ci} = 3.7 \times 10^{10} \text{ dps} = 3.7 \times 10^{10} \text{ Bq.}$$

Absorbed Dose

20. The absorbed dose is the amount of ionisation energy absorbed by a mass of tissue exposed to radiation. The classical unit is the **radiation absorbed dose** (rad) which is equivalent to 100 ergs/gm. The SI unit is the **gray** (Gy) which is equivalent to 1 joule/ kg and 1 Gy = 100 rad.

Equivalent Dose

21. This is an indication of potential biological damage caused in humans by ionising radiation. Different types of ionising radiation transfer energy to tissues at different rates and the equivalent dose is derived by multiplying the absorbed radiation dose (rad or Gy) by a variable radiation weighting factor (W_R) which is related to the radiation's rate of linear energy transfer, that is, the amount of energy given up to a material per distance travelled by a particle or photon. The linear energy transfer varies directly with the mass and charge and inversely with the energy of the radiation. Particles such as alpha rays have a high rate of linear energy transfer, so even though they do not penetrate far, they give up substantial amounts of energy to the tissues they actually do penetrate. Gamma and x-rays on the other hand penetrate far into tissues but have a relatively low rate of linear energy transfer. The W_R for alpha radiation is therefore high (20) whereas for gamma and x-radiation the W_R is 1. The W_R for beta particles varies between 1 – 1.7. The classical unit for equivalent dose is the **roentgen equivalent man** (rem) where 1 rem = rad x W_R . The corresponding SI unit is the **Sievert** (Sv) where 1 Sv = Gy x W_R and 1Sv = 100 rem. 1Sv = 1 joule/kg of tissue.
22. Equivalent dose is a better guide to stochastic effects than it is to deterministic effects.

Effective Dose

23. The relationship between the probability of detrimental effects and the equivalent dose also depends on the organ or tissue irradiated. The factor by which the equivalent dose in tissue (T) is weighted is called the tissue weighting factor, W_T , which represents the relative contribution of that organ or tissue to the total detrimental effect.
24. The sum of all the tissue weighting factors is 1 which is the W_T value that would be used for uniform whole body irradiation from an external source or from intake of a radioisotope such as tritiated water which would be uniformly distributed throughout the body. The unit for effective dose is the sievert (Sv) measured as joules/kg.
25. Effective dose = sum of (absorbed dose x W_R x W_T) for each of the organs or tissues irradiated.
26. Radiation weighting factors (W_R) for different types of radiation, and tissue weighting factors (W_T) for different organs of the body, are set out in the tables below:

Radiation Type	Radiation Weight Factor (WR)
X-rays, gamma rays (γ)	1
Beta particles	11.7
Alpha particles	20

Table 2: Radiation Weighting Factors

Tissue or Organ	Tissue Weighting Factor (WT)
Gonads	0.20
Bone marrow (red)	0.12
Colon	0.12
Lung	0.12
Stomach	0.12
Bladder	0.05
Breast	0.05
Liver	0.05
Oesophagus	0.05
Thyroid	0.05
Skin	0.01
Bone surface	0.01
Remainder	0.05

Table 3: Tissue Weighting Factors

TYPES OF RADIATION ACCIDENT

Exposure

27. A patient is irradiated but no radioactive material contaminates the body or clothing. Exposure to radiation does not make the tissues radioactive. These patients pose no risk to others including medical attendants.

Contamination

28. Radioactive material contaminates the patient. It may be present externally on the clothing, skin or in wounds or internally following ingestion, inhalation or absorption through skin, mucous membranes and wounds. Radioactive contamination may be a source of continuous whole body or localised exposure to radiation. External contamination may also comprise a small risk to the patient's attendants if they do not cover their exposed body surfaces which touch the patient. Internal contamination presents a hazard to staff only if they come into direct contact with the patient's urine or faeces.

Incorporation

29. Following internal contamination, radioactive atoms or molecules may become incorporated into the patient's tissues, for example, radioactive iodine may become incorporated into thyroid tissue, caesium to muscle, strontium and phosphorus into the bone.

Types of Radiation Exposure	
(1)	EXTERNAL IRRADIATION Whole body or localised No risk to attendant personnel

(2)	CONTAMINATION External Internal
(3)	INCORPORATION Into organs or tissues; thyroid, liver, lungs, bone

Table 4: Summary of Types of Radiation Exposure

RADIATION BIOLOGY

General

- 30.** Ionising radiation transfers energy to atoms and molecules in biological systems creating highly energetic ion pairs comprising a positively charged moiety and a free electron. These may in turn interact with other atoms and molecules to form free radicals. Most important quantitatively is the production of free radicals from water which then interact with other target molecules such as components of cell membranes, cell proteins or chromosomes.
- 31.** Structural damage to cell membranes may cause changes in permeability and the release of lysozymes. Damage to individual proteins is of little consequence as they are rapidly replaced by the cell. Chromosomes are the most important target of ionising radiation as there are only one or two copies of DNA per cell. In DNA, damaged nucleotide bases are easily repaired as are single strand breaks in the deoxyribose chain. Double strand breaks, however, are not as readily repaired especially if base damage occurs simultaneously on both strands. This results in broken chromosomes with no template for repair. The exposed ends of chromosomal fragments may join up at random resulting in morphological chromosomal abnormalities. Radiation damage to DNA may be **stochastic** in which non-lethal damage causes clinical effects such as carcinogenesis or **deterministic** in which damage to DNA causes cell death. Cell death occurs when cells attempt to divide and cannot do so. In rapidly dividing tissues such as granulocytes and mucosal epithelium, cell death occurs early whereas in slowly dividing tissues such as connective tissue, cell death may be delayed for months or even years.

CLINICAL EFFECTS OF IONISING RADIATION

- 32.** Ionising radiation may produce both systemic and local clinical effects. Many of the early symptoms and signs of radiation injury are delayed in onset and non-specific in nature making diagnosis difficult. This is compounded if a patient is unaware of having been in contact with a radioactive source.

Local Radiation Injury

- 33.** The potential for localised exposure to radiation occurs most commonly from sealed industrial radiography gamma sources and occasionally from exposure to x-rays from x-ray analysis machines. Symptoms of whole body irradiation will not occur unless the epigastrium is irradiated. Full blood examination is usually normal and chromosomal analysis may detect some dicentric forms. Initial symptoms may be absent or may consist only of tingling and hypersensitivity. Erythema may not appear for some days but if it does occur in less than 48 hours, the lesion will probably progress to ulceration. If irradiated skin is of normal appearance by 72 hours, the lesion is likely to be less severe but may

still ulcerate in one to two weeks. Erythema may be delayed for up to 30 days and the later it occurs the less severe is the lesion. Pain is minimal unless ulceration or the dose is extreme. Burn depth and area should be charted as for thermal burns. The area of burn is often small, being confined to the area of contact. Healing occurs slowly and incompletely, because of underlying obliterative endarteritis. The skin becomes pigmented and thin with a paucity of subcutaneous fat and may be tender to pressure, heat and cold. Stiffness of small joints may occur due to cartilage and synovial damage. Treatment is conservative and consists of splinting, physiotherapy and prevention of infection. Amputation is performed only if gangrene supervenes. Grafting and skin flaps are indicated for areas of exposed cartilage, bone or tendon and for areas of severe scarring but will fail if performed too early before the full extent of the lesion demarcates. Nuclear medicine tissue perfusion studies and arteriography may help to determine blood supply to damaged tissue. In the long-term an irradiated area must be watched for the possible development of neoplastic change.

34. Local irradiation of the eye may produce posterior cataracts and a base line slit lamp examination with regular review is important. Local irradiation of the gonads may cause sterility which is transient at lower radiation doses but may be permanent at higher doses.

Acute Radiation Syndrome

35. The acute radiation syndrome occurs when there has been significant whole body irradiation. There are four phases:
- Prodrome.
 - Latent period.
 - Manifest illness.
 - Death or recovery.
36. The time of onset of these phases and their duration are inversely proportional to the radiation dose received and in severe cases the rapid progression of the illness makes differentiation of the various phases impossible.
37. The prodrome is non-specific with nausea and vomiting, headache and lassitude. There follows a latent phase during which the patient becomes relatively well for a few days or weeks to be followed by a phase of manifest illness. The pattern of illness and its severity during this phase depend on the dose and distribution of radiation received. Tissues with a high rate of cellular turnover and replication such as the haemopoietic system and the gastrointestinal tract are the most radio-sensitive. A number of different syndromes are described, their features predominating at particular doses of radiation, though more seriously affected individuals show features affecting all body systems.
38. The median lethal whole body dose with no treatment is in the region of 3.5 to 4 gray (350–400 rad). Patients receiving less than 1gray (100 rad) are likely to be asymptomatic.

Haemopoietic Syndrome (Dosage range 2 – 10 Gy (200 – 1000 rad))

39. Refer to Figure 1 when reading this section. When the dose received is less than 10 Gy there is some hope of survival and most of the significant clinical

features of the acute radiation syndrome are due to bone marrow depression. The prodromal symptoms are delayed several hours, are relatively mild in severity and improve by 48 hours. Two to three weeks later bone marrow depression becomes clinically evident with haemorrhage and infection. Erythrocyte numbers are usually maintained because mean red cell survival time is 120 days.

40. Treatment of the prodrome is supportive and includes appropriate reassurance, anti-emetics, sedatives and re-hydration. The most useful indicators of radiation dose and predictors of subsequent haematological deterioration are the absolute lymphocyte count in the first 48 hours and chromosomal analysis of blood lymphocytes for dicentric fragments. Chromosomal abnormalities occur within hours of radiation exposure, but the analysis takes 48 hours. They give a more accurate prognosis than does the lymphocyte count. In severe cases, there may be an initial neutrophilia in response to acute inflammatory processes.
41. Minimally-affected patients can be discharged for a period of time to decrease the risks of hospital acquired opportunistic infections but frequent haematological monitoring is required. Severely bone marrow depressed patients should be kept in strict isolation and the use of antibacterial and antiviral agents considered, to sterilise the gastrointestinal and upper respiratory tracts and to control reactivated infections such as herpes simplex.
42. The role of bone marrow transplantation is not well defined and is still controversial. If undertaken it should be performed at around 10 – 14 days post irradiation as the nadir of the platelet and white cell count usually occurs at 30–40 days and it takes 14 days for the transplanted marrow to become effective.
43. Irradiated or radioactively contaminated patients with concomitant traumatic injuries experience haematological deterioration at an earlier stage. All administered blood products should be irradiated to remove the T cell population in order to minimise graft versus host reactions.
44. Platelets should be transfused if the platelet count is less than $20 \times 10^9/L$ and if surgery is anticipated the platelet count should be maintained at greater than $75 \times 10^9/L$. Potentially septic areas of thermal burns should be excised early. Grafting should also occur early. Wounds should be closed early if this is surgically acceptable. Otherwise, closure of some wounds may need to be delayed for several months, ie until after the haemopoietic syndrome.

Gastrointestinal Syndrome (Dosage range 10 – 15 Gy (1000 – 1500 rad))

45. At these radiation doses, the gastrointestinal syndrome precedes and is superimposed on the bone marrow depression which itself occurs early. The prodromal symptoms are followed approximately a week later by severe vomiting and diarrhoea which if bloody or accompanied by fever is a bad prognostic sign. Initial intestinal hyper-motility is followed by ileus. There is denudation of intestinal villi, damage to the intestinal micro-circulation and a local immunological deficit due to destruction of the 450 micron mucous barrier. Septicaemia and vascular collapse result.

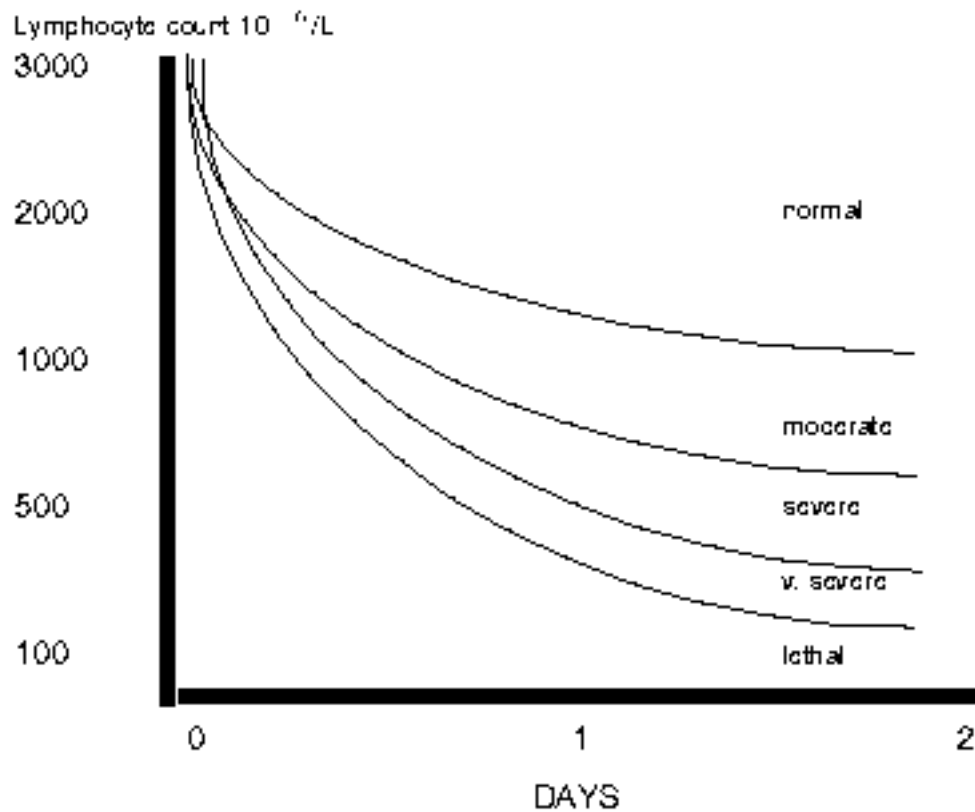

Figure 1: Lymphocyte Count as a Guide to Severity of the Haemopoietic Syndrome

46. Treatment of the gastrointestinal syndrome includes intravenous re-hydration, total parenteral nutrition and diets containing selenium and particular amino acids. Half the persons exposed to 10 Gy succumb despite maximal intensive care and bone marrow transplantation.

Vascular Syndrome (Dosage range 15 – 30 Gy (1500 – 3000 rad))

47. Capillary dilation and leakiness leads to marked fluid translocation including the development of cerebral oedema. In addition there is release of chemical mediators from cells leading to hypotension and shock. Death usually occurs within two weeks.

Cerebral Syndrome (Dosage greater than 30 Gy (3000 rad))

48. Following extremely high radiation exposure to a large part of the body by gamma or x-rays in doses exceeding 30 Gy (3000 rad), there is almost immediate nausea, vomiting, diarrhoea and prostration with rapid progression to cardiovascular instability, confusion, ataxia, convulsions and coma. It is thought these effects are a consequence of cell membrane damage. Death occurs within 24 to 48 hours.

CHRONIC EFFECTS OF IONISING RADIATION

49. Delayed effects of ionising radiation may not be expressed clinically until one or more years after the initial exposure which in some cases may have been insufficient to cause acute clinical symptoms.

Deterministic Injury

50. Deterministic injuries are threshold-dependent. Cells are killed when they receive a radiation dose which varies with different tissues. Clinical expression occurs when irradiation causes an amount of cell killing that cannot be compensated for by proliferation of viable cells. An example of deterministic injury is fibro atrophy occurs when tissue is destroyed following exposure to radiation and is replaced by fibrous tissue which then interferes with the blood supply to more distal tissues. Another example is cataract formation affecting the posterior surface of the lens appearing about 10 months following excessive exposure of the eye to ionising radiation. This is earliest delayed effect.

Stochastic Injury

51. Sub-lethal doses of radiation may produce cellular and tissue damage which is repairable. There may be, however, residual damage to the cells' DNA which may become clinically expressed at a later time.
52. The probability of this happening is proportional to the radiation dose and it is assumed that there is no threshold level below which the probability of DNA damage is zero. Such non-threshold dependent effects are referred to as stochastic. Clinical expression may occur not only in the affected individual but potentially also in the offspring and future generations if gonadal cells are involved.
53. Stochastic processes in somatic tissues may induce neoplastic mutations which are later expressed as malignancies. This is the most important delayed effect of ionising radiation. Some tissues are more prone to neoplastic mutation and malignancies strongly associated with exposure to ionising radiation include leukaemias (all types except chronic lymphocytic) and cancers of all tissues which have been assigned a tissue weighting factor. There is usually a latent period averaging five to seven years for leukaemias and up to 40 years for solid tumours. The excess incidence of leukaemias in an exposed population peaks between 7–15 years after exposure then falls back to natural baseline at

around 25 years. Children are more prone to radiation induced carcinogenesis. It is to be noted that even though the incidence of malignancy is increased, the ages at which malignancies are clinically expressed coincide with the age groups in which they usually arise in the community.

Reproductive Tissues

54. Fertility may be temporarily or permanently impaired depending on the dose of radiation received. In males, oligospermia is most marked between 45 and 60 days following radiation exposure. The period of infertility is a function of the radiation dose received. The male secondary sexual characteristics are not affected. In women, the age of exposure to radiation is important. All ova are present at birth and younger females require larger radiation doses to become sterile. Radiation-induced infertility in females is associated with symptoms of premature menopause. Sub-lethal radiation damage to gametal DNA may produce mutant characteristics which may be expressed in a patient's children and future generations. It is recommended that procreative sexual intercourse should be avoided for six months following gonadal radiation exposure to high doses. However, this effect does not seem to be as prominent in humans as it is in animal studies.

A. WHOLE BODY IRRADIATION	
Dose	Clinical Effect
0.1 Gray, (Gy)	Chromosomal abnormalities
0.25 0.50 Gy	Changes in numbers of lymphocytes and platelets
1 Gy	Mild radiation sickness
4 Gy	LD ₅₀
6 Gy	Without medical treatment almost 100% will die from haemopoietic syndrome
10 Gy	Gastrointestinal syndrome. Even with bone marrow transplantation approx. 50% will die from GIT syndrome
1530 Gy	Death within two weeks from septic shock
above 30 Gy	Cerebrovascular syndrome. Death within 48 hours.

B. LOCAL IRRADIATION		
Dose	Organ	Clinical Effect
0.15 Gray (Gy)	Gonads	Reduction in sperm count
3 Gy	Skin	Epilation
6 Gy	Skin	Erythema
69 Gy	Eye	Cataract
10 Gy	Skin	Blistering
50 Gy	Skin	Prompt painful skin burn

Table 5: Effects of Acute Radiation Exposure

PREGNANCY

55. The effects of ionising radiation on the developing embryo or foetus depend on its gestation when the pregnant female is exposed. Irradiation during the first 10 days post-conception appears to have an all or none effect resulting in either death of the embryo and spontaneous abortion or continued normal growth and development with no deleterious sequelae. Irradiation of the foetus during the period of organogenesis may result in congenital abnormalities and foetal death. Between the 8th and 15th weeks of gestation, radiation exposure is associated with mental retardation (with a coefficient of about 30 IQ points per sievert) and during the third trimester may result in growth and developmental retardation.

OVERVIEW OF EMERGENCY MEDICAL MANAGEMENT

56. The principles of resuscitation of acute life threatening injury or medical illness are unchanged and take precedence over all other considerations. Neither contamination nor exposure to less than massive doses of irradiation cause acute patient illness. For patients presenting as a result of an accident involving ionising radiation, however, additional measures are undertaken to detect and remove external contamination and to reduce internal contamination and incorporation. Patients are treated symptomatically for the prodrome of acute radiation sickness. Blood samples and other biological samples are collected for biological dosimetry which can give an indication of prognosis. An assessment is made of acute local radiation injury and conservative management is initiated. Attention must be paid to the psychological welfare of the patient.
57. Normal medical and nursing procedures should be followed as closely as possible.

SPECIFIC EMERGENCY MEDICAL MANAGEMENT ISSUES

External Contamination

58. External contamination occurs when radioactive debris contaminates the patients skin and contributes to local or whole body radiation exposure. Decontamination procedures aim to remove as much surface radioactive material as possible and to prevent secondary internal contamination. These procedures may need to be performed simultaneously with the medical treatment of injury and illness and should proceed until monitoring reveals the lowest achievable radiation levels. All particulate wastes should be placed in designated receptacles for analysis and disposal by radiation experts. Staff not actually engaged in clinical procedures should stand well back from contaminated patients. If recommended by the radiation physicist, attending staff should wear personal radiation monitoring devices such as film badges, thermoluminescent dosimeters and quartz fibre electrometers. The use of such devices is not warranted if the radioactive material is a pure alpha emitter. A radiation physicist is essential to operate and oversee monitoring equipment.
59. Decontamination is achieved by simple irrigation and washing. A saline swab of contaminated areas should be kept for isotope analysis. Gentle swabbing with a soft brush is permissible but care should be taken to avoid splashing and skin damage. Detergents, hydrogen peroxide, 3 per cent hypochlorite solution and potassium permanganate may be useful in some cases. Eyes should be irrigated from medial to lateral to avoid contaminating the lacrimal ducts. Ear

canals should be dry swabbed and irrigated, provided the drum is intact. The scalp should be shampooed. Embedded foreign bodies should be removed with long forceps and placed in a lead container.

Internal Contamination

- 60.** Internal contamination occurs when radioactive material is absorbed through wounds, burns, or the gastrointestinal or respiratory tracts. There are usually no acute clinical effects and it is usually not feasible to confirm the presence of internal contamination before commencing treatment which is directed at reduction of absorption, prevention of incorporation into tissues and promotion of elimination.
- 61.** Reduction of absorption through wounds is achieved by removal of foreign bodies and irrigation. Hydrogen peroxide may be useful for difficult cases. The excision of tissue may be justified if there is gross contamination with foreign material. Burns should be cleaned and debrided.
- 62.** Measures used to decontaminate the gastrointestinal tract include mouth washes and the use of Ipecac or gastric lavage to empty the stomach. Purgatives and enemas may reduce radionuclide absorption and reduce local exposure of the gastrointestinal tract, especially the distal colon. Alginates and antacids containing aluminium may reduce strontium absorption and barium sulphate may reduce both strontium and radium absorption. Prussian blue is useful for caesium ingestion.
- 63.** Respiratory tract decontamination is difficult other than by oropharyngeal rinsing, Lung lavage is very unpleasant, of uncertain efficacy and is rarely indicated.
- 64.** Although they do not help in the initial decontamination process, nasal and oral swabs, excreta (Sputum, faeces, urine) and wound swabs should be kept to allow identification of the isotope, confirmation of internal contamination and estimation of the absorbed dose. Repeated surveys for radioactivity are made throughout decontamination procedures.

Incorporation

- 65.** Incorporation occurs when a radionuclide is taken up and concentrated in a body tissue. With iodine and caesium this may occur within a few hours. Institutions using radioactive substances should have the appropriate therapeutic agent available on-site for pre-hospital use.
- 66.** Reduction of incorporation may be achieved by several means. A blocking agent is a compound of a stable element which blocks the uptake of radionuclide in a target organ, for example stable potassium iodide for iodine-131 exposures as may occur following a nuclear reactor accident. Isotopic dilution involves the administration of a stable compound of the same element as the radionuclide so as to reduce the proportion of radionuclide taken up by the target organ, for instance stable strontium in radio-strontium exposures. Displacement therapy involves administering a stable isotope of a different element than the radionuclide to act as a competitor for uptake sites. Calcium, for example, may reduce the incorporation of radioactive strontium. Chelating agents, such as penicillamine in cobalt poisoning, may reduce incorporation and promote radionuclide excretion by the formation of a soluble non-toxic complex which is excreted by the kidney. Mobilising agents increase the natural rate of turnover of a biological molecules and therefore increase excretion of

radioactive elements which have become incorporated into molecules in tissues. An example is the use of anti-thyroid drugs in iodine-131 exposures.

- 67.** Enhancement of elimination is most effective if commenced early but chelating and mobilising agents may be useful for up to two weeks. Excreta analysis and whole body gamma monitoring will determine the need for continuing therapy.

CHAPTER 17

CHARACTERISTICS OF BIOLOGICAL AGENTS

GENERAL

Definitions

1. The following definitions are used in this document:
 - A biological agent is a micro-organism or product which causes disease in man, plants or animals, or causes the deterioration of material.
 - Biological warfare (BW), or operations, is the employment of biological agents to produce casualties in man or animals and damage to plants or material; or defence against such deployments.
 - An aerosol is a suspension of small particles (liquid or solid) in air. Common examples are mists, fogs and smokes, however, an established biological aerosol is invisible.

Characteristics

2. The most important characteristics of micro-organisms is that they are living. Their other essential characteristics are as follows:
 - **Infectivity**—A greater infectivity means that fewer micro-organisms are required. It does not mean that the symptoms and signs of disease appear more quickly or are more severe;
 - **Virulence**—Different strains or the same micro-organism may produce diseases of different severity. The most virulent strain produces the most acute or severe effects;
 - **Incubation**—The incubation period is the time between the infective penetration of micro-organisms into the body and the appearance of the symptoms of the disease. It is not normally less than 24 hours;
 - **Transmissibility**—Some micro-organisms produce infection which may be transmitted from man to man (eg plague), and thus may cause an epidemic. However, others (eg anthrax) are not;
 - **Lethality**—Some micro-organisms will produce diseases which are usually lethal if the target populations is not immune. Others will give rise to illnesses which are incapacitating rather than lethal (eg influenza), except for the infirm or very young;
 - **Selection**—The characteristics of the BW agent chosen in terms of transmissibility, incapacitation, and/or lethality will depend on the effect required in the target population.

In general the non-transmissible agent affects will be easier to control.

CLASSIFICATION

Micro-Organisms

3. Micro-organisms which may be used in BW can be classified according to cell characteristics. Details of the diseases they cause in humans are in Annex A to Chapter 18; the following categories are of interest:
 - **Viruses**—Viruses are sub-microscopic packages of protein coated nucleic acids. They require living cells on which to multiply and are dependent on the cells of the host which they infect. Viruses do not respond to antibiotic treatment;
 - **Bacteria**—Bacteria are small free-living organisms most of which can be grown easily in the laboratory. They have a cell structure and they reproduce by simple division. The diseases they produce often respond to treatment using antibiotics;
 - **Rickettsiae**—Rickettsiae and chlamydiae are bacteria. They grow within living cells. They have a cell structure and are susceptible to antibiotic treatment;
 - **Fungi**—Fungi may be regarded as primitive plants which do not use photosynthesis, drawing nutrition from decaying vegetable matter and do not require oxygen for growth. Most fungi exist in a yeast-like state or as resistant spores.

Toxins

4. Toxins are poisonous compounds initially isolated from living organisms but which may be reproduced synthetically. Toxins are classified as biological agents by international convention and some are listed in Annex A, Chapter 18 and Annex A, Chapter 20. The medical issues related to toxins are dealt with in Chapter 20 as in civilian practice they are managed as chemicals.

SELECTION AND DELIVERY

Selection Considerations

5. Considerations for a micro-organism to be selected as a BW agent include the following:
 - **Production**—Easy to produce in quantity.
 - **Storage**—Easy to store while maintaining virulence. There are three main storage methods. These are:
 - as resistant spores (eg anthrax);

- in liquid growth media, although many micro-organisms do not survive storage in this form for many months; and
- as ‘freeze-dried’ powder (the technology now exists to store some BW agents in this form for many years).
- **Immunity**—No widespread or naturally acquired immunity against the chosen micro-organism should exist in the target population.
- **Virulence**—The agent should be virulent and effective in low dosages.
- **Incubation Period**—The agent should have a relatively short incubation period.
- **Ease of Dissemination.**
- **Environmental Stability.**
- **Ease of Handling.**

Sensitivity to the Environment

6. Various environmental factors affect the use of micro-organisms as airborne BW agents and thus reduce their effectiveness:
 - **Atmospheric Stability**—A BW agent cloud may be rapidly dispersed in unstable atmospheric conditions. These occur about seven to eight per cent of the time in NW Europe.
 - **Wind Speed**—A high wind speed will carry an agent cloud quickly past the victim who may therefore be less at risk.
 - **Temperature and Humidity**—The survival of BW agents is best assured by conditions of moderate temperature and high humidity.
 - **Atmospheric Pollution**—Because of the chemical composition of atmospheric pollution, it has an adverse effect on BW agents.
 - **Sunlight**—Most micro-organisms are killed by exposure to ultra-violet light (sunlight); spores are an exception. BW attacks are therefore more likely at night with the appearance of sunlight being used to limit the spread of the active agent.
 - **Precipitation**—BW agents tend to have very small particle size. They are unlikely to be washed out of the atmosphere by rain and snow.
7. A liquid medium/micro-organism ‘soup’ can be used to preserve live BW agents in the atmosphere. This liquid medium is a complex substance which:
 - protects the agent from excessive atmospheric drying;
 - provides the degree of nutrition to the agent whilst airborne; and

- protects the agent during the transition from liquid to aerosol state by the use of an anti-foaming additive.

Delivery

8. Micro-organisms can be delivered in aerosol suspension or as liquid contamination by the use of the protective soup. Each droplet will consist of many micro-organisms grouped together. The size of each droplet can be determined by the characteristics of the dispenser.
 - **Vectors**—The use of animals or insects, known as ‘vectors’ for the delivery of micro-organisms is a possibility. However, in a BW attack vectors cannot be relied upon to behave in a predictable and concerted manner.
 - **Explosive Munitions**—Explosive munitions normally consist of a small explosive burster which is surrounded by the BW agent fill and enclosed in a thin metal or plastic case. Each munition forms a bomblet within a full sized bomb or artillery round. The bomblets are designed to disperse over a wide area when released. On impact the burster explodes and disseminates its fill as an aerosol suspension. The heat and shock of the explosion usually kills some of the micro-organisms.
 - **Aerosol**—The apparatus required to deliver BW agent aerosols is relatively simple and can be man portable or mounted on an aircraft, vehicle or ship. Such delivery systems can be used to drift agent clouds on the wind over very large areas.
 - **Likely Methods**—The most likely delivery methods for BW agents are:
 - direct release of spores or agent ‘soup’ to contaminate environment;
 - direct delivery of agent by clandestine action; or
 - release into the prevailing wind in an aerosol suspension of:
 - * liquid agent ‘soup’; or
 - * spores or dried powdered agent.

CHAPTER 18

BIOLOGICAL WEAPONS–EFFECTS

GENERAL

1. The purpose of this chapter is to provide an overview of potential biological warfare agents directed against humans, problems that might be created during an attack in which a biological agent is utilised, and the current methods available to health personnel for recognising, preventing, and managing these problems.

FACTORS INFLUENCING USE OF BIOLOGICAL AGENTS

Scope of the Problem

2. Biological weapons are unique in their ability to inflict large numbers of casualties over a wide area with minimal logistical requirements, and by means which can be virtually untraceable. The ease and low cost of producing an agent, the difficulty in detecting its presence and protecting (and treating) its intended victims, and the potential to selectively target humans, animals, or plants conspire to make defence against this class of weapon particularly difficult.
3. Australia remains highly vulnerable to the strategic, tactical, and terrorist use of biological weapons. As the military and economic gaps between nations grow and as some less advantaged nations seek a balance of power, there may be a tendency by these nations to overcome their disadvantage by choosing weapons of mass destruction that can be produced easily and cheaply. The relative cost of weapons/delivery systems can be seen in the table below.

Weapon	Cost Unit Per KM ²
Biological	1
Chemical	600
Nuclear	800
Conventional	2000

Table 1: Relative Cost of Weapons/Delivery Systems

BEHAVIOUR AND RECOGNITION OF BIOLOGICAL WEAPONS

Characteristics of Biological Agents

4. This paragraph expands on information in Chapter 17. Intrinsic features of biological agents which influence their potential for use as weapons include: infectivity; virulence; toxicity; pathogenicity; incubation period; transmissibility; lethality; and stability. Unique to many of these agents, and distinct from their

chemical counterparts, is the delay effect, due to the need for the organisms to replicate a sufficient number of times to produce the clinical picture.

- **Infectivity**—The infectivity of an agent reflects the relative ease with which micro-organisms establish themselves in a host species. Pathogens with high infectivity cause infection with relatively few organisms, while those with low infectivity require a larger number. High infectivity does not necessarily mean that the symptoms and signs of disease appear more quickly, nor that the illness is more severe.
- **Virulence**—The virulence of an agent reflects the relative severity of disease produced by that agent. Different micro-organisms and different strains of the same micro-organism may cause diseases of different severity.
- **Toxicity**—The toxicity of an agent reflects the relative severity of illness or incapacitation produced by a toxin.
- **Pathogenicity**—The capability of an infectious agent to cause disease in a susceptible host.
- **Incubation Period**—A sufficient number of micro-organisms or quantity of toxin must penetrate the body to initiate infection (the infective dose), or intoxication (the intoxicating dose). Infectious agents must then multiply (replicate) to produce disease. The time between exposure and the appearance of symptoms is known as the incubation period. This is governed by many variables, including: the initial dose; virulence; route of entry; rate of replication; and host immunological factors.
- **Transmissibility**—Some biological agents can be transmitted from person-to-person directly. Indirect (for example, via arthropod vectors) may be a significant means of spread as well. In the context of BW casualty management, the relative ease with which an agent is passed from person-to-person (that is, its transmissibility) constitutes the principal concern.
- **Lethality**—This reflects the relative ease with which an agent causes death in a susceptible population.
- **Stability**—The viability of an agent is affected by various environmental factors, including temperature, relative humidity, atmospheric pollution, and sunlight. A quantitative measure of stability is an agent's decay rate (for example, 'aerosol decay rate').
- Additional factors which may influence the suitability of a micro-organism or toxin as a biological weapon include: ease of production; stability when stored or transported; suitability for genetic modification; ease of encapsulation; and ease of dissemination.

Classification

5. Taxonomic classification of biological agents is important to the health services in terms of detection, identification, prophylaxis, and treatment. Biological agents which may be used as weapons (see Annex A) can be classified as follows:
 - **Bacteria**—Bacteria are small free-living organisms, most of which may be grown on solid or liquid culture media. The organisms have a structure consisting of nuclear material, cytoplasm, and cell membrane. They

reproduce by simple division. The diseases they produce often respond to specific therapy with antibiotics. They include the following:

- *Rickettsiae*—These are bacteria. They possess metabolic enzymes and cell membranes, utilise oxygen, and are susceptible to broad spectrum antibiotics. Like viruses, they grow only within living cells.
- *Chlamydia*—These are bacteria that are obligatory intracellular parasites incapable of generating their own energy source. Like bacteria, they are responsive to broad-spectrum antibiotics. Like viruses and rickettsia, they require living cells for multiplication.
- *Viruses*—These are organisms which require living cells in which to replicate. They are therefore intimately dependent upon the cells of the host which they infect. They produce diseases which generally do not respond to antibiotics, but which may be responsive to antiviral compounds, of which there are few available, and those that are available are of limited use.
- **Fungi**—Fungi are primitive plants which do not utilise photosynthesis, are capable of anaerobic growth, and draw nutrition from decaying vegetable matter. Most fungi form spores, and free-living forms are found in soil. The spore forms of fungi are operationally significant. Fungal diseases may respond to various antimicrobials.

Dissemination

6. Dissemination is the process by which infectious agents or toxins are dispersed to cause disease or intoxication. The same routes of entry pertinent to natural spread of diseases (that is, through inhalation, ingestion, or percutaneous inoculation) are also relevant when the aetiological agents are delivered intentionally by weapons. Biological agents are most likely to be delivered covertly, and by aerosol. Other routes of entry are thought to be less important than inhalation, but are nonetheless potentially significant. See Chapter 8 also. Methods and other aspects of dissemination are as follows:

- **Aerosols:**
 - *Respiratory Exposure (Inhalation)*—Inhalation of agent aerosols, with resultant deposition of infectious or toxic particles within alveoli, provides a direct pathway to the systemic circulation. The natural process of breathing causes a continuing influx of biological agent to exposed individuals. The major risk is pulmonary retention of inhaled particles. Droplets as large as 20 microns can infect the upper respiratory tract; however, these relatively large diameter particles generally are filtered by natural anatomic and physiological processes, and only much smaller particles, ranging from 0.5 – 5 microns, reach the alveoli efficiently. Still smaller droplets are inhaled, but they are not efficiently retained in humans. Aerosol delivery systems aim to generate invisible clouds with particles or droplets between 0.5 and 10 microns in diameter, which can remain suspended for long periods. Smaller sized particles are relatively unstable under ambient environmental conditions. Infection by the respiratory route may induce disease at doses lower than those generally associated with naturally-acquired infections by the oral route. The subsequent illness may differ from the natural pattern, and the incubation period may be much shorter.

- *Alimentary Exposure (Ingestion)*—Food and water supplies may be contaminated during an aerosol BW attack. Unwary consumption of such contaminated materials could result in disease.
- *Dermal Exposure (Percutaneous)*—Intact skin provides an excellent barrier for most, but not all, biological agents (for example, T2 mycotoxin). However, mucous membranes and damaged skin constitute breaches in this normal barrier, through which agents may readily pass.
- **Contamination of Food and Water**—Direct contamination of consumables, such as drinking water, foodstuffs, or medications, could be used as a means to disseminate infectious agents or toxins. This method of attack would be most suitable for sabotage activities and might be used against limited targets such as water supplies or food supplies. Filtration and adequate chlorination significantly reduce this hazard as it pertains to water.
- **Other Considerations**—Attempts might be made to spread typical vector-borne diseases by releasing infected natural (or unnatural) arthropod hosts such as mosquitoes, ticks or fleas. These live vectors can be produced in large numbers and be infected by allowing them to feed on infected animals, infected blood reservoirs, or artificially produced sources of a biological agent.
- Long-term survival of infectious agents, preservation of toxin activity during extended periods, and the protective influence of dust particles onto which micro-organisms adsorb when spread by aerosols have all been documented. The potential exists, therefore, for the delayed generation of secondary aerosols from previously contaminated surfaces. To a lesser extent, particles may adhere to an individual or to clothing, creating additional but less significant exposure hazards.
- Person-to-person spread with certain potential biological agents has been documented. Humans, as an unaware and highly effective carrier of a communicable agent, could readily become a source of dissemination (for example, with plague or smallpox). This risk can be reduced with personal protection.

Recognition

7. With current technology, it is likely that a biological attack will be completed before emergency services, or their health advisers, are aware that it has taken place. Medical officers must attempt to distinguish between an epidemic of natural origin and a BW attack. Specific considerations include the following:
 - Biological agents are likely to be delivered covertly.
 - Sick individuals may be the initial indication that an attack has occurred. Distinguishing a BW attack from background endemic disease may be difficult under some circumstances. Mixed infections or intoxications may occur, thereby complicating or delaying diagnosis.
 - A large number of casualties may occur during a short period of time.
 - Targets may be large geographical areas or smaller objectives. The size of an area in which casualties occur can help narrow the list of likely agents. For example, certain biological agents, like toxins, can be used

most effectively on smaller targets, while others can be disseminated efficiently over extremely large areas (for example anthrax spores).

- Rapid detection and definitive identification of suspected biological agents are essential for tactical and political, as well as health purposes.
- Atmospheric conditions are critical to the effective use of biological agents. In general, the optimal time for use of biological weapons is during the late night and early morning. It is during these hours that inactivation of biological aerosols by ultra-violet radiation is minimal. In addition, neutral or inversion conditions are most likely to be present at these times. The phenomenon of atmospheric inversion best allows an agent cloud to travel along the land surface.

PHYSIOLOGICAL EFFECTS

8. A summary of the possible agents is in Annex A, Chapter 18. Individual agents are addressed in annexes to Chapter 19.

Annex:

- A. Medical Classification of Potential Biological Warfare Diseases

MEDICAL CLASSIFICATION OF POTENTIAL BIOLOGICAL WARFARE DISEASES

This table shows those diseases whose causative organisms have been considered as potential biological agents. Its contents should not be construed as a sanctioned threat list.

BACTERIAL

Anthrax
Brucellosis
Cholera
Meliodosis
Plague (pneumonic)
Psittacosis
Shigella
Tularemia
Typhoid fever
Rickettsial

RICKETTSIAL

Epidemic typhus
Q fever
Rocky mountain spotted fever
Scrub typhus

FUNGAL

Coccidioidomycosis
Histoplasmosis

VIRAL

Argentine haemorrhagic fever
Bolivian haemorrhagic fever
Chikungunya fever
Crimean-Congo haemorrhagic fever
Dengue fever
Ebola
Eastern equine encephalitis
Influenza
Korean haemorrhagic fever (Hantaan)
Lassa
Omsk haemorrhagic fever
Rift Valley fever
Russian spring—summer encephalitis
Smallpox
Western equine encephalitis
Venezuelan equine encephalitis
Yellow fever

TOXINS

Botulinum toxins
Clostridium perfringens toxins
Mycotoxins—of trichothecene group
Palytoxin
Ricin
Saxitoxin
Staphylococcal enterotoxins
Tetrodotoxin

CHAPTER 19

BIOLOGICAL INCIDENT–MEDICAL MANAGEMENT

GENERAL

1. Precise diagnosis of biological agent casualties in a CBR environment is likely to be difficult. Signs and symptoms of biological agent infection or intoxication are common to many diseases. Biological incident casualties may coexist with conventional, radiological/nuclear, and/or chemical incident casualties. Adequate or appropriate laboratory facilities may not be available locally (ie confirmatory laboratory diagnosis may have to come from another state or territory). The treatment required for biological casualties will not differ in basic principle from that in persons suffering from the same disease incurred by natural means.

CLINICAL MANAGEMENT

2. Concurrent considerations should include the following:
 - **General Supportive Measures**—Measures should be taken to lower temperature; relieve pain; maintain respiration; and secure an intravenous access for the administration of drugs and fluids. Symptomatic treatment and treatment of coexisting injuries should follow established principles.
 - **Isolation Procedures (Refer to existing local guidelines)**—In the context of biological agent casualties, adherence to principles of patient isolation is essential to preventing cross-infection with transmissible agents. Separation of non-affected individuals from contaminated victims of biological agent (cohorting; reverse quarantine) and implementation of appropriate nursing procedures should be initiated as soon as practical after a biological incident.
 - **Antibiotic Therapy**—In situations where an incident has been confirmed, antibiotics **must** be given to all biological casualties (refer to antibiotic guidelines), with consideration of prophylaxis for exposed staff. Most bacterial, chlamydial, and rickettsial diseases respond to antibiotics. The choice of drug depends on the clinical circumstances, but one broad-spectrum antibiotic should be administered in full therapeutic doses, parentally if possible, and preferably intravenously, and commenced at the earliest possible level of health care. The choice of antibiotic will depend upon many factors, including the specific threat or threats, evidence or suspicion of natural antibiotic resistance among strains, and the ease with which drug resistance can be artificially engineered. Where applicable, specific guidelines are included in Annex A. Management issues include supply of sufficient quantities, stockpiling, distribution methods and whether or not there would be selective distribution.
 - **Antiviral Therapy**—The only ‘broad-spectrum’ antiviral drug currently available is ribavirin. This compound has been a useful adjunct to the

treatment of some potential viral threats when they have occurred under natural conditions (Lassa fever, Crimean-Congo haemorrhagic fever, haemorrhagic fever with renal syndrome). In addition, there is evidence of antiviral activity in vitro and in vivo against certain other viruses (influenza, Junin virus, Rift Valley fever virus), but little or no activity is seen with other (filoviruses, togaviruses) agents. Other antiviral drugs, such as amantadine, acyclovir, and azidothymidine, are restricted in their therapeutic spectrum to single virus families, and thus have little application as non-specific antivirals. Where applicable, specific guidelines are included in Annexes.

Note: Anti-virals have limited applicability and there is currently no effective mass use drug.

Anti-viral Medications

3. There are several anti-viral medications already in existence including the following:
 - **Acyclovir and BVDU** (bromo vinyl deoxuridine)—These are effective against the herpes group of viruses, under experimental conditions.
 - **PFA** (trisodium phosphonoformate)—This is a virus inhibiting drug, which is also effective against the herpes group including herpes virus 1 and 2, Epstein Barr virus, human cytomegalovirus and Marek's disease virus.
 - **Amantadine and Rimantadine**—These appear to block the virus replication of influenza A virus. Rimantadine was used in the USSR during the 1977/78 epidemic; it appeared to reduce clinical signs and febrile responses. A reduced morbidity rate from 71 to 14 per cent was claimed and it is significant that the drug was given before exposure, or within the first three days, emphasising that virus replication must be blocked at an early stage.
 - **Ribavirin**—This is a synthetic nucleotide which inhibits the replication of both RNA and DNA virus following its activation by phosphorylation by cellular adenosine kinase. Experimentally, it has inhibited influenza A and B viruses, by inhalation of a drug aerosol. Ribavirin appears to be active against the herpes group and arenaviruses (eg lassa fever). The activity of the drug appears to be less obvious against picorna-, rhabdo- and arboviruses.
 - **Interferon(s)**—Interferons are glycoproteins which differ in activity and stability according to the species of cell (fibroblast, leucocyte or lymphocyte) in which they are stimulated. The activity of interferons is complex, as they certainly depresses viral replication but also may inhibit cell growth and proliferation. Interferons have shown themselves to be effective experimentally against type 4 rhinovirus (by nasal spray), yellow fever, influenza B and Venezuelan encephalomyelitis viruses. The degree and type of activity of interferon against viruses would appear to be dose related; interferon itself may also be toxic in high doses.

General

4. Paragraphs 2. – 4. are intended for guidance only. The medical officer may be faced with many patients who are clearly dying, and if no diagnosis can be made it may be necessary to employ a pharmacological blunderbuss of combined antibiotic and steroid therapy. The critical factor would be whether a lethal or incapacitating agent has been used. If reports are received from the attacked location that personnel are already dying, then consideration should be given to using such treatment on all patients. This approach may be similar for toxins.

MASS CASUALTY MANAGEMENT

5. There will be significant differences in the methods of providing basic health care in mass casualty situations. Unlike a typical mass casualty situation, few of these patients will require surgery.
6. Although many individuals becoming ill from an attack with a biological weapon would likely present for medical evaluation over a short time span, all would not become casualties simultaneously. An exception to this pattern might be seen following an attack with a toxin.

MEDIA ADVICE

7. An essential aspect of health management in such a situation may include media who can play a significant role in allaying anxiety. This could be done effectively only if everyone in the area (both civilian and military) could be assured that the cause of the illness is known, the course of the disease could be described with reasonable accuracy, and the outcome could be predicted. This type of assurance could be provided only if an accurate aetiologic diagnosis can be made shortly after the onset of illness. If this assurance cannot be provided, the psychological response might create greater problems than the disease itself. The National Emergency Media Relations Network (NEMRN) managed by the Commonwealth Department of Health and Aged Care is one experienced and useful national resource.

INFECTION CONTROL

8. Infection Control and Quarantine. Health care workers should follow the local infection control guidelines. The quarantining of victims of an incident carries significant legal implications. Any need to restrict freedom as a result of an infectious diseases incident should be initiated by the Public Health Unit, as its officers have the necessary powers under the Act.

Clinical Information (Annexes A–L)

9. The enclosed data sheets provide clinical information to assist in the recognition, diagnosis and management of selected diseases, well recognised for their potential as biological weapons. It is not intended to be comprehensive.
10. Many products referenced are currently considered investigational new drugs (IND). This indicates that the product (drug, vaccine, antitoxin, etc) has been shown to be safe and effective in animal studies, and has been approved for limited use as an investigational product in humans. In general, IND products (not produced in Australia) must be obtained through official channels from the government of the producing nation, and administered under a research protocol approved by a recognised institutional review board.

Annex:

- A. Biological Agents Summary
- B. Anthrax
- C. Brucellosis
- D. Cholera
- E. Crimean-Congo Hemorrhagic Fever
- F. Melioidosis
- G. Plague
- H. Q Fever
- I. Rift Valley Fever
- J. Smallpox
- K. Tularemia
- L. Venezuelan Equine Encephalitis

Biological agents summary

Type of Micro Organism	Disease (Category)	Transmission (human to human)	Dissemination	Typical			Therapy	Vaccination	Symptoms
				Delay of Symptoms (Days)	Duration of Illness	Mortality			
See Note (a) at end of Table	Chikungunya Fever (non-lethal)	No	Vector/ Aerosol	2-6	2 weeks	<1%	None	None	Incapacitating joint and spine pains
	Dengue Fever (non-lethal)	No	Vector/ Aerosol	5-8	Days to weeks	<1%	None	None yet	Fever, Headaches, muscle pain
	Eastern Equine Encephalitis (lethal)	No	Vector/ Aerosol	5-15	1-3 weeks	>60%	None	None yet	Headache, fever, vomiting, bone pains
	Tick borne Encephalitis (lethal)	No	Vector/ Contact/ Droplets	7-14	1 week to months	Up to 30%	None	Available	Headache, fever, vomiting, delirium, coma, paralysis
	Japanese Encephalitis (lethal)	No	Vector/ Airborne droplets	2-3	1 week	25%	None	Not good	Headache, fever, stupor, delirium, coma
	Rift Valley Fever (non-lethal)	No	Direct/ Aerosol	4-6	1-2 weeks	Low	None	Experimental	Fever, malaise, muscular pain, vomiting
	Influenza ^(a) (non-lethal)	Moderate	Aerosol	1-3	3-10 days	Low	None	Available	Well known
	Yellow Fever (lethal)	No	Vector/ Aerosol	3-6	1-2 weeks	<40%	None	Available	General aches, prostration, vomiting, epistaxis, jaundice
	Small Pox (lethal)	High	Aerosol/ Vector/ Direct	7-16	12-24 days	<35%	None	Available	Fever, malaise, aches, pains, skin eruptions

Type of Micro Organism	Disease (Category)	Transmission (human to human)	Dissemination	Typical			Therapy	Vaccination	Symptoms
				Delay of Symptoms (Days)	Duration of Illness	Mortality			
Rickettsia	Q-Fever (non-lethal)	No	Vector	10–21	1–3 weeks	<1%	Effective	None yet	Chills, fever, headache, pains, disorientation
	Psittocosis (non-lethal)	Rare	Aerosol	4–15	1 week plus	Low	Effective	None	Severe influenza symptoms
	Rocky Mountain Spotted Fever (non-lethal)	No	Vector/Aerosol	3–10	2 weeks to months	<80%	Effective	None yet	Headache, chills, fevers, muscle pains, rash, toxemia
	Epidemic Typhus (lethal)	No	Vector/Aerosol	6–15	Weeks to months	<70%	Effective	Available	Headache, chills, fevers, muscle pains, rash
Bacteria	Pulmonary Anthrax (lethal)	No	Vector/Aerosol	1–5	3–5 days	100%	Effective	Available	Malignant pustules are not symptoms of pulmonary anthrax. Symptoms are influenza-like
	Brucellosis (non-lethal)	No	Aerosol/Direct	7–21	Weeks to years	2-6%	Moderately effective	None yet	Variable, fever, depression, exhaustion, aches
	Cholera (lethal)	High	Aerosol/Direct	1–5	1 or more weeks	<80%	Moderately effective	Available	Well known gastro-intestinal
	Glanders (lethal)	No	Aerosol/Direct	2–14	46 weeks	100%	Little	None	Ulcerated lesions, joint aches
	Melioidosis (lethal)	No	Aerosol/Direct	15	420 days	100%	Moderately effective	None	Rapid glanders

- (a) Approximately 2000 people die each year from known circulating strains. A new strain or version of an existing strain not covered by existing vaccines where the population immunity is low to zero would cause very high mortality—a Pandemic. The ‘Spanish flu’ of 1918–19 killed 20 million. Refer A Framework for an Australian Influenza Pandemic Plan produced by the Communicable Diseases Network of Australia and New Zealand, June 1999.

ANTHRAX

CLINICAL SYNDROME

1. Anthrax is a zoonotic disease caused by *Bacillus anthracis*. Under natural conditions, humans become infected by contact with infected animals or contaminated animal products.
2. Human anthrax is usually manifested by cutaneous lesions. A biological warfare attack with anthrax spores delivered by aerosol would cause inhalation anthrax, an extraordinarily rare form of the naturally occurring disease, and gut infection.

Clinical Features of Inhalation Disease

3. The disease begins after an incubation period varying from one to six days, presumably dependent upon the dose of inhaled organisms. Onset is gradual and non-specific, with fever, malaise, and fatigue, sometimes in association with a non-productive cough and mild chest discomfort. In some cases, there may be a short period of improvement. The initial symptoms are followed in two to three days by the abrupt development of severe respiratory distress with dyspnoea, diaphoresis, stridor, and cyanosis. Physical findings may include evidence of pleural effusions, oedema of the chest wall, and meningitis. Chest x-ray reveals a dramatically widened mediastinum, often with pleural effusions, but typically without infiltrates. Shock and death usually follow within 24–36 hours of respiratory distress onset.

DIAGNOSIS

Routine Laboratory Findings

4. Laboratory evaluation will reveal a neutrophilic leucocytosis. Pleural and cerebrospinal fluids may be haemorrhagic.

Differential Diagnosis

5. An epidemic of inhalation anthrax in its early stage with non-specific symptoms could be confused with a wide variety of viral, bacterial, and fungal infections. Progression over two to three days with the sudden development of severe respiratory distress followed by shock and death in 24–36 hours in essentially all untreated cases eliminates diagnoses other than inhalation anthrax. The presence of a widened mediastinum on chest x-ray, in particular, should alert one to the diagnosis. Other suggestive findings include chest-wall oedema, haemorrhagic pleural effusions, and haemorrhagic meningitis. Other diagnoses to consider include aerosol exposure to SEB; but in this case onset would be more rapid after exposure (if known), and no prodrome would be evident prior to onset of severe respiratory symptoms. Mediastinal widening on chest x-ray will also be absent. Patients with plague or tularaemia pneumonia will have pulmonary infiltrates and clinical signs of pneumonia (usually absent in anthrax).

Specific Laboratory Diagnosis

6. *Bacillus anthracis* will be readily detectable by blood culture with routine media. Smears and cultures of pleural fluid and abnormal cerebrospinal fluid may also be positive. Impression smears of mediastinal lymph nodes and spleen from fatal cases should be positive. Toxaemia is sufficient to permit anthrax toxin detection in blood by immunoassays.

THERAPY

7. Almost all cases of inhalation anthrax in which treatment was begun after patients were symptomatic have been fatal, regardless of treatment.

Historically, penicillin has been regarded as the treatment of choice, with two million units given intravenously every two hours. Tetracyclines and erythromycin have been recommended in penicillin-sensitive patients. The vast majority of anthrax strains are sensitive in vitro to penicillin. However, penicillin-resistant strains exist naturally, and one has been recovered from a fatal human case. Moreover, it is not difficult to induce resistance to penicillin, tetracyclines, erythromycin, and many other antibiotics through laboratory manipulation of organisms. All naturally occurring strains tested to date have been sensitive to erythromycin, chloramphenicol, gentamicin, and ciprofloxacin. In the absence of information concerning antibiotic sensitivity, treatment should be instituted at the earliest signs of disease with oral ciprofloxacin (1000 mg initially, followed by 750 mg po bid) or intravenous doxycycline (200 mg initially, followed by 100 mg q 12 hrs). Supportive therapy for shock, fluid volume deficit, and adequacy of airway may all be needed.

PROPHYLAXIS

Vaccine

8. A licensed, alum-precipitated preparation of purified B. anthracis protective antigen (PA) has been shown to be effective in preventing or significantly reducing the incidence of inhalation anthrax. Limited human data suggest that after completion of the first three doses of the recommended six-dose primary series (0, 2, 4 weeks, then 6, 12, 18 months), protection against both cutaneous and inhalation anthrax is afforded. Studies in rhesus monkeys indicate that good protection is afforded after two doses (10–16 days apart) for up to two years. It is likely that two doses in humans is protective as well, but there is too little information to draw firm conclusions. As with all vaccines, the degree of protection depends upon the magnitude of the challenge dose; vaccine-induced protection is undoubtedly overwhelmed by extremely high spore challenge. At least three doses of the vaccine (at 0, 2, and 4 weeks) are recommended for prophylaxis against inhalation anthrax. Contraindications for use are sensitivity to vaccine components (formalin, alum, benzethonium chloride) and/or history of clinical anthrax. Reactogenicity is mild to moderate: up to six per cent of recipients will experience mild discomfort at the inoculation site for up to 72 hours (tenderness, erythema, oedema, and pruritus). While a smaller proportion (<1%) will experience more severe local reactions (potentially limiting use of the extremity for one to two days); modest systemic reactions (myalgia, malaise, low-grade fever) are uncommon, and severe systemic reactions (anaphylaxis, which precludes additional vaccination) are rare. The vaccine should be stored at refrigerator temperature (not frozen).

Antibiotics

9. Choice of antibiotics for prophylaxis is guided by the same principles as that for treatment; ie it is relatively easy to produce a penicillin-resistant organism in the laboratory, and possible, albeit somewhat more difficult, to induce tetracycline resistance. Therefore, if there is information indicating that a biological weapon attack is imminent, prophylaxis with ciprofloxacin (500 mg po bid), or doxycycline (100 mg po bid) is recommended. If unvaccinated, a single 0.5 ml

dose of vaccine should also be given subcutaneously. Should the attack be confirmed as anthrax, antibiotics should be continued for at least four weeks in all exposed. In addition, two 0.5 ml doses of vaccine should be given two weeks apart in the unvaccinated. Those previously vaccinated with fewer than three doses should receive a single 0.5 ml booster. Vaccination is probably not necessary for those who have received the initial three doses within the previous six months primary series. Upon discontinuation of antibiotics, patients should be closely observed; if clinical signs of anthrax occur, patients should be treated as indicated above. If vaccine is not available, antibiotics should be continued beyond four weeks until the patient can be closely observed upon discontinuation of therapy.

BRUCELLOSIS

CLINICAL SYNDROME

1. Brucellosis is a systemic zoonotic disease caused by one of four species of bacteria: *Brucella melitensis*, *B. abortus*, *B. suis*, and *B. canis*; virulence for humans decreases somewhat in the order given. These bacteria are small gram-negative, aerobic, non-motile coccobacilli that grow within monocytes and macrophages. They reside quiescently in tissue and bone marrow, and are extremely difficult to eradicate even with antibiotic therapy. Their natural reservoir is domestic animals, such as goats, sheep, and camels (*B. melitensis*); cattle (*B. abortus*); and pigs (*B. suis*). *Brucella canis* is primarily a pathogen of dogs, and only occasionally causes disease in man. Humans are infected when they inhale contaminated aerosols, ingest raw (unpasteurized) infected milk or meat, or have abraded skin or conjunctival surfaces that come in contact with the bacteria. Laboratory infections are quite common, but there appears to be no human-to-human transmission; isolation of infected patients is therefore not required.
2. *Brucella* species long have been considered potential candidates for use in biological warfare. The organisms are readily lyophilised, perhaps enhancing their infectivity. Under selected environmental conditions (for example, darkness, cool temperatures, high CO₂), persistence for up to two years has been documented. When used as a biological warfare agent, Brucellae would most likely be delivered by the aerosol route; the resulting infection would be expected to mimic natural disease.

Clinical Features

3. Brucellosis presents after an incubation period normally ranging from three to four weeks, but may be as short as one week or as long as several months. Clinical disease presents typically as an acute, non-specific febrile illness with chills, sweats, headache, fatigue, myalgias, arthralgias, and anorexia. Cough occurs in 15–25 per cent, but the chest x-ray usually is normal. Complications include sacroiliitis, arthritis, vertebral osteomyelitis, epididymo-orchitis, and rarely endocarditis. Physical findings include lymphadenopathy in 10–20 per cent and splenomegaly in 20–30 per cent of cases. Untreated disease can persist for months to years, often with relapses and remissions. Disability may be pronounced. Lethality may approach six per cent following infection with *B. melitensis*, but the disease is rarely fatal (0.5 per cent or less) after infection with other serotypes (usually after endocarditis develops).

DIAGNOSIS

Routine Laboratory Findings (Non-contribution)

4. **Differential Diagnosis**—The initial symptoms of brucellosis are usually non-specific. The differential diagnosis is therefore very broad and includes bacterial, viral, and mycoplasmal infections. The systemic symptoms of viral

and mycoplasmal illnesses, however, are usually present for only a few days, while they persist for prolonged periods in brucellosis. Brucellosis may be indistinguishable clinically from the typhoidal form of tularaemia or from typhoid fever itself.

5. ***Specific Laboratory Diagnosis***—Serology by agglutination or ELISA may suggest the diagnosis. A definitive diagnosis of brucellosis is established by culture of blood or bone marrow, which may be positive in up to 70 per cent and 90 per cent of cases, respectively.

THERAPY

6. The recommended treatment is doxycycline (200 mg/day) plus rifampin (900 mg/day) for six weeks. Alternative effective treatment consists of doxycycline (200 mg/day) for six weeks plus streptomycin (1 g/day) for three weeks. Trimethoprim- sulfamethoxazole given for four to six weeks is less effective. In five to ten per cent of cases, there may be relapse or treatment failure. Laboratory infections with brucellosis are quite common but there is no human to human transmission and isolation is not required.

PROPHYLAXIS

7. Killed and live attenuated human vaccines have been available in many countries, but are of unproven efficacy. There is no information on the use of antibiotics for prophylaxis against human brucellosis.

CHOLERA

CLINICAL SYNDROME

1. Cholera is a diarrhoeal disease caused by *Vibrio cholerae*, a short, curved, gram- negative bacillus. Humans acquire the disease by consuming water or food contaminated with the organism. The organism multiplies in the small intestine and secretes an enterotoxin that causes a secretory diarrhoea. When employed as a BW agent, cholera will most likely be used to contaminate water supplies. It is unlikely to be used in aerosol form.

Clinical Features

2. Cholera may present as mild diarrhoea or as a fulminant disease characterised by profuse watery diarrhoea, with fluid losses exceeding five to ten litres or more per day. Without treatment, death may result from severe dehydration, hypovolemia and shock. Vomiting is often present early in the illness and may complicate oral replacement of fluid losses. There is little or no fever or abdominal pain.

DIAGNOSIS

Routine Laboratory Findings

3. On microscopic examination of stool samples there are few or no red cells or white cells. Serum electrolytes may demonstrate hypokalemia or, if inappropriate fluid replacement has been given, may show hypernatremia or hyponatremia. Acidosis and renal failure may accompany severe dehydration.

Differential Diagnosis

4. Watery diarrhoea can also be caused by enterotoxigenic *E. coli*, rotavirus or other viruses, noncholera vibrios, or food poisoning due to ingestion of preformed toxins such as those of *Clostridium perfringens*, *Bacillus cereus* or *Staphylococcus aureus*.

Specific Laboratory Diagnosis

5. Vibrios can be identified in stool by darkfield or phase contrast microscopy, and *Vibrio cholerae* can be grown on a variety of culture media. Bacteriologic diagnosis is not necessary to treat cholera or related watery diarrhoeas.

THERAPY

6. Treatment of cholera depends primarily on replacement of fluid and electrolyte losses. This is best accomplished using oral rehydration therapy with the World Health Organisation solution (3.5 g NaCl, 2.5 g NaHCO₃, 1.5 g KCl and 20 g glucose per litre). Intravenous fluid replacement is occasionally needed when vomiting is severe, when the volume of stool output exceeds seven litres/day, or

when severe dehydration with shock has developed. Antibiotics will shorten the duration of diarrhoea and thereby reduce fluid losses. Tetracycline (250 mg every six hours for three to five days) or doxycycline (200 mg initially followed by 100 mg every 12 hours for three to five days) is generally adequate. Other effective drugs include ampicillin (250 mg every six hours for five days) and trimethoprim sulfamethoxazole (one tablet every 12 hours for three to five days).

PROPHYLAXIS

7. Improved oral cholera vaccines are presently being tested. Vaccination with the currently available killed suspension of *V. cholerae* provides about 50 per cent protection that lasts for no more than six months. The initial dose is two injections given at least one week apart, with booster doses every six months.

CRIMEAN–CONGO HAEMORRHAGIC FEVER

CLINICAL SYNDROME

1. Crimean-Congo haemorrhagic fever (CCHF) is a viral disease caused by CCHF virus. The virus is transmitted by ticks, principally of the genus *Hyalomma*, with intermediate vertebrate hosts varying with the tick species. The disease was first recognised in the Crimea, but occurs over most of Africa, the Middle East, the Balkans, the USSR, and eastern China. Little is known about variations in the virus properties over the huge geographic area involved. Humans become infected through tick bites, crushing an infected tick, or at the slaughter of viremic livestock. (Domestic animals become infected but do not have significant disease.) The spread of disease within hospitals has been documented with this virus and poses a potentially significant problem. Even in epidemics, cases do not show narrow clustering and person-to-person spread is rare. CCHF would probably be delivered by aerosol if used as a BW agent.

Clinical Features

2. Typical cases present with sudden onset of fever and chills three to twelve days after tick exposure. Flushing, conjunctival injection, and mild hypotension may be present. After two to three days, perhaps with a temporary remission of fever, the patient develops bleeding manifestations such as petechiae, ecchymoses, oozing from puncture sites, maelena, haematuria, and GI haemorrhage. Crimean-Congo haemorrhagic fever may cause quite severe ecchymoses and extensive GI bleeding. There is severe headache, lumbar pain, nausea and vomiting, delirium, and prostration. Fatal cases are associated with extensive haemorrhage, coma, and shock. Other common physical findings are epigastric tenderness, modest hepatomegaly, and less frequently icterus.
3. Mortality among cases recognised as haemorrhagic fever is 15–30 per cent. Convalescence in survivors is prolonged with asthenia, dizziness, and often hair loss. Milder clinical disease, occurs in an unknown proportion of infections. There may be geographic variations, possibly related to viral strain differences.

DIAGNOSIS

Differential Diagnosis

4. Thrombocytopenia and elevated AST may provide a clue to suggest CCHF in the febrile patient seen early in the course of infection. Other viral haemorrhagic fevers, meningococemia, rickettsial diseases, and similar conditions may resemble full-blown CCHF. Particular care should be taken in the case of massive GI bleeding not to confuse CCHF with surgical conditions.

Routine Laboratory Findings

5. Leucopenia, thrombocytopenia, and elevated AST are all seen early. Abnormal coagulation tests are common and usually indicate DIC. Platelets ≤ 20000 /ml, APT ≥ 260 sec, or AST ≥ 200 U/ml carry a poor prognosis.

Specific Laboratory Diagnosis

6. Most fatal cases and half the others will have detectable antigen by rapid ELISA testing of acute serum samples. IgM ELISA antibodies occur early in recovery. IgG ELISA and fluorescent antibodies also show rising titers. Virus isolation in suckling mice is usually successful from acute sera.

THERAPY

7. Supportive therapy with replacement of clotting factors is indicated. Crimean-Congo haemorrhagic fever virus is sensitive to ribavirin in vitro and clinicians have been favourably impressed in uncontrolled trials. Patients should be treated with intravenous ribavirin (30 mg/kg followed by 15 mg/kg q 6 h for four days and 7.5 mg/kg q 8 h for six days). Mild reversible anaemia may occur.
8. Immune globulin has also been recommended but is available only in Bulgaria.
9. Because of several well-defined outbreaks within hospitals, protective measures for health personnel are an issue. The weight of evidence points to large droplets or fomites as the mediators of transmission and so strict barrier nursing is indicated and probably sufficient for the care of naturally acquired disease. The virus is aerosol-infectious and additional precautions (for example, respirators) might be considered in a biological warfare setting.

PROPHYLAXIS

10. Although there is little field experience and no definitive data on efficacy, the sensitivity of the virus to ribavirin and the severity of disease suggests that prophylaxis of high risk exposures is indicated. Persons with percutaneous exposure to contaminated needles or instruments and those exposed directly to fresh blood from CCHF patients should receive 400 mg ribavirin po qid for one day and then continue with 400 mg po tid for seven days after the last exposure. If more than 48h have elapsed after the first such exposure, 30 mg/kg should be given IV followed by three IV doses of 15 mg/kg at eight hourly

intervals; then continue with 400 mg po q 8 h. If there is GI intolerance, the 400 mg oral dose can be substituted with 180 mg IV. Monitoring for anaemia is suggested.

- 11.** In the case of a suspected biological attack, ribavirin could be considered for prophylaxis, but there is insufficient information to make a firm recommendation for dosing. Use of 400 mg QID may result in mild to modest anaemia in some recipients, GI intolerance in a small proportion, and the drug is embryopathic in rodents; there are unresolved issues of reversible testicular damage in rodents.
- 12.** An inactivated mouse-brain vaccine is used in Bulgaria, but there is no general experience with this product.

MELIOIDOSIS

CLINICAL SYNDROME

1. Melioidosis is an infectious disease of humans and animals caused by *Burkholderia pseudomallei*, a gram-negative bacillus. It is especially prevalent in Southeast Asia but has been described from many countries around the world. The disease has a variable and inconstant clinical spectrum. A biological warfare attack with this organism would most likely be by the aerosol route, however, it can also be used to contaminate a water supply. (See *also* description in Antibiotic Guidelines published by VPMF.)

Clinical Features

2. Infection by inoculation may/may not result in a subcutaneous nodule with haematogenous spread, generally with fever.
3. Pneumonia may occur after inhalation or haematogenous dissemination of infection. It may vary in intensity from mild to fulminant, usually involves the upper lobes, and often results in cavitation. Pleural effusions are uncommon. An acute fulminant septicemia may occur characterised by rapid appearance of hypotension and shock. A chronic suppurative form may involve virtually any organ in the body.

DIAGNOSIS

Routine Laboratory Findings

4. The white blood cell count may range from normal to 20 000 per mm³, and a mild anaemia may develop during the illness.

Differential Diagnosis

5. Melioidosis should be considered in the differential diagnosis of any febrile illness, especially if multiple pustular skin or subcutaneous lesions develop, if the illness presents with fulminant respiratory failure, or there is a chest x-ray pattern suggestive of tuberculosis but without acid-fast bacilli on smear.

Specific Laboratory Diagnosis

6. Microscopic examination of sputum or purulent exudates will reveal small, gram- negative bacilli with bipolar staining using methylene blue or Wright's stain. *B. pseudomallei* can be cultured on routine or selective media and identified by standard bacteriologic procedures. A number of serological tests are useful in diagnosis when they show a fourfold titer rise in paired sera.

THERAPY

7. See current edition of Antibiotic Guidelines, published by VMPF Therapeutics Committee.

PROPHYLAXIS

8. There are no means of immunisation. Vigorous cleansing of abrasions and lacerations may reduce the risk of disease after inoculation of organisms into the skin.
9. There is no information available on the utility of antibiotic prophylaxis after a potential exposure, before the onset of clinical symptoms.

PLAGUE

CLINICAL SYNDROME

1. Plague is a zoonotic disease caused by *Yersinia pestis*. Under natural conditions, humans become infected as a result of contact with rodents, and their fleas. The transmission of the gram-negative coccobacillus is by the bite of the infected flea, *Xenopsylla cheopis*, the oriental rat flea, or *Pulex irritans*, the human flea. Under natural conditions, three syndromes are recognised: bubonic, primary septicemic, or pneumonic. In a biological warfare scenario, the plague bacillus could be delivered via contaminated vectors (fleas) causing the bubonic type or, more likely, via aerosol causing the pneumonic type.

Clinical Features

2. In bubonic plague the incubation period ranges from two to ten days. The onset is acute and often fulminant with malaise, high fever, and one or more tender lymph nodes. Inguinal lymphadenitis (bubo) predominates, but cervical and axillary lymph nodes can also be involved. The involved nodes are tender, fluctuant, and necrotic. Bubonic plague may progress spontaneously to the septicemic form with organisms spread to the central nervous system, lungs (producing pneumonic disease), and elsewhere. The mortality is 50 per cent in untreated patients with the terminal event being circulatory collapse, haemorrhage, and peripheral thrombosis. In primary pneumonic plague the incubation period is two to three days. The onset is acute and fulminant with malaise, high fever, chills, headache, myalgia, cough with production of a bloody sputum, and toxemia. The pneumonia progresses rapidly, resulting in dyspnea, stridor, and cyanosis. In untreated patients, the mortality is 100 per cent with the terminal event being respiratory failure, circulatory collapse, and a bleeding diathesis.

DIAGNOSIS

Presumptive

3. Presumptive diagnosis can be made by identification of the gram-negative coccobacillus with safety-pin bipolar staining organisms in Giemsa or Wayson's stained slides from a lymph node needle aspirate, sputum, or cerebrospinal fluid (CSF) samples. When available, immunofluorescent staining is very useful. Elevated levels of antibody to *Y. pestis* in a nonvaccinated patient may also be useful.

Definitive

4. *Yersinia pestis* can be readily cultured from blood, sputum, and bubo aspirates. Most naturally occurring strains of *Y. pestis* produce an 'F1' antigen in vivo, which can be detected in serum samples by immunoassay. A fourfold rise of *Y. pestis* antibody levels in patient serum is also diagnostic.

Differential

5. In cases where bubonic type is suspected, tularaemia adenitis, staphylococcal or streptococcal adenitis, meningococemia, enteric gram-negative sepsis, and rickettsiosis need to be ruled out. In pneumonic plague, tularemia, anthrax, and staphylococcal enterotoxin B (SEB) agents need to be considered. Continued deterioration without stabilisation effectively rules out SEB. The presence of a widened mediastinum on chest x-ray should alert one to the diagnosis of anthrax.

THERAPY

6. Plague may be spread from person to person by droplets. Strict isolation procedures for all cases are indicated. Streptomycin, tetracycline, and chloramphenicol are highly effective if begun early. Significant reduction in morbidity and mortality is possible if antibiotics are given within the first 24 hours after symptoms of pneumonic plague develop. Intravenous doxycycline (200 mg initially, followed by 100 mg every 12 hours), intramuscular streptomycin (1 g every 12 hours), or intravenous chloramphenicol (1 g every six hours) for 10–14 days are effective against naturally occurring strains. Supportive management of life-threatening complications from the infection, such as shock, hyperpyrexia, convulsions, and disseminated intravascular coagulation (DIC), need to be initiated as they develop.

PROPHYLAXIS

7. A formalin-killed *Y. pestis* vaccine is produced in the United States and has been extensively used. Efficacy against flea-borne plague is inferred from population studies, but the utility of this vaccine against aerosol challenge is unknown. Reactogenicity is moderately high and a measurable immune response is usually attained after a three-dose primary series: at zero, one and four to seven months. To maintain immunity, boosters every one to two years are required. Live-attenuated vaccines are available elsewhere, but are highly reactogenic and without proven efficacy against aerosol challenge.

Q FEVER

CLINICAL SYNDROME

1. Q fever is a zoonotic disease caused by a rickettsia, *Coxiella burnetii*. The most common animal reservoirs are sheep, cattle and goats. Humans acquire the disease by inhalation of particles contaminated with the organisms. A biological warfare attack would cause disease similar to that occurring naturally.

Clinical Features

2. Following an incubation period of 10–20 days, Q fever generally occurs as a self-limiting febrile illness lasting two days to two weeks. Pneumonia occurs frequently, usually manifest only by an abnormal chest x-ray. A non-productive cough and pleuritic chest pain occur in about one-fourth of patients with Q fever pneumonia. Patients usually recover uneventfully. Uncommon complications include chronic hepatitis, endocarditis, aseptic meningitis, encephalitis and osteomyelitis.

DIAGNOSIS

Routine Laboratory Findings

3. The white blood cell count is elevated in one third of patients. Most patients with Q fever have a mild elevation of hepatic transaminase levels.

Differential Diagnosis

4. Q fever usually presents as an undifferentiated febrile illness, or a primary atypical pneumonia, which must be differentiated from pneumonia caused by mycoplasma, Legionnaires' disease, psittacosis or *Chlamydia pneumoniae*. More rapidly progressive forms of pneumonia may look like bacterial pneumonias including tularemia or plague.

Specific Laboratory Diagnosis

5. Identification of organisms by staining sputum is not helpful. Isolation of the organism is difficult and impractical. The diagnosis can be confirmed serologically.

THERAPY

6. Tetracycline (250 mg every 6 hr) or doxycycline (100 mg every 12 hr) for five to seven days is the treatment of choice. A combination of erythromycin (500 mg every 6 hr) plus rifampin (600 mg per day) is also effective.

PROPHYLAXIS

Vaccination

7. A single dose vaccination with a killed suspension of *C. burnetii* provides complete protection against naturally occurring Q fever and >90 per cent protection against experimental aerosol exposure in human volunteers. Protection lasts for at least five years. Administration of this vaccine in immune individuals may cause severe cutaneous reactions including necrosis at the inoculation site. Newer vaccines are under development. Treatment with tetracycline during the incubation period will delay but not prevent the onset of illness.

RIFT VALLEY FEVER

CLINICAL SYNDROME

1. Rift Valley fever (RVF) is a viral disease caused by RVF virus. The virus circulates in sub-Saharan Africa as mosquito-borne agent. Epizootics occur when susceptible domestic animals are infected, and, because of the large amount of virus in their serum, amplify infection to biting arthropods. Deaths and abortions among susceptible species such as cattle and sheep constitute a major economic consequence of these epizootics, as well as providing a diagnostic clue and a method of surveillance. Humans become infected by the bite of mosquitoes or by exposure to virus-laden aerosols or droplets. Although disease may occur during an unexceptional rainy season, outbreaks are typically associated with very high densities of arthropod vector populations that may occur during heavy and prolonged rains or in association with irrigation projects. During epidemics the virus may be transmitted by many species of mosquitoes; its potential for introduction into areas with susceptible livestock and dense mosquito populations is believed to be high, as exemplified by a major epidemic in the Nile valley in 1977–79. The human disease appears to be similar whether acquired by aerosol or by mosquito bite. A biological warfare attack, most likely delivered by aerosol, would be expected to elicit the rather specific spectrum of human clinical manifestations and to cause disease in sheep and cattle in the exposed area. If disease occurred in the absence of heavy vector populations or without domestic animals as amplifiers of mosquito infection, a BW attack would also be a likely cause. Domestic animals are probably susceptible to aerosol infection or could be covertly infected to initiate an epidemic which might propagate itself by the usual means.

Clinical Features

2. The incubation is two to five days and is usually followed by an incapacitating febrile illness of similar duration. The typical physical findings are fever, conjunctival injection, and sometimes abdominal tenderness. A few petechiae or epistaxis may occur. A small proportion of cases (approximately one per cent) will progress to a viral haemorrhagic fever syndrome, often with associated hepatitis. These cases may manifest petechiae, mucosal bleeding, icterus, anuria, and shock; mortality in this group is roughly 50 per cent. A similar proportion will develop clinically significant ocular changes; macular lesions associated with retinal vasculitis, haemorrhage, oedema, and infarction. Ocular manifestations begin after the patient enters convalescence from his acute illness and about half of the patients will have permanent visual defects. A small number of infections will lead to a late encephalitis. After apparent recovery from a typical febrile illness, the patient develops fever, meningeal signs, obtundation, and focal defects. These patients may die or often have serious sequelae

DIAGNOSIS

Differential Diagnosis

3. The clinical syndrome in an individual is not pathognomonic, but the occurrence of an epidemic with febrile disease, haemorrhagic fever, eye lesions, and encephalitis in different patients would be characteristic of RVF.

Routine Laboratory Findings

4. In acute uncomplicated disease, there is often a transient leucopenia, but liver and clotting function tests are normal. In haemorrhagic fever, abnormalities of hepatic and coagulation tests are proportional to severity of disease. DIC may be present. Patients with encephalitis have up to several hundred cells/mm in CSF, predominantly lymphocytes.

Specific Laboratory Diagnosis

5. Demonstration of viral antigen in blood by ELISA is rapid and successful in a high proportion of acute cases of uncomplicated disease or haemorrhagic fever. IgM antibodies appear with cessation of viremia and are present when ocular or CNS manifestations are noted. False positive reactions may occasionally be noted in patients with multiple sandfly fever infections. Encephalitis patients have IgM and IgG antibodies in CSF. A proportion of cases should be studied by classical means such as determination of neutralising antibodies and virus isolation. Wide-scale surveillance is readily accomplished by simultaneous determination of IgG (infection or vaccination at an indeterminate time) and IgM (recent exposure) antibodies in human or domestic animal blood.

THERAPY

6. In haemorrhagic fever, supportive therapy may be indicated for hepatic and renal failure, as well as replacement of coagulation factors. The virus is sensitive to ribavirin *in vitro* and in rodent models. No studies have been performed in man or the more realistic monkey model to ascertain whether administration to an acutely ill patient would be of benefit. It would be reasonable to treat patients with early signs of haemorrhagic fever with intravenous ribavirin (30 mg/kg followed by 15 mg/kg q 6 h for four days and 7.5 mg/kg q 8 h for six days). This regimen is safe and effective in haemorrhagic fevers caused by some viruses, although a reversible anaemia may appear. Therapy may be stopped two to three days after improvement begins or antibody appears. Penetration of ribavirin into the CNS is slow and perhaps limited, but in the absence of any other specific therapy, the drug might be used in ocular and encephalitic cases.

PROPHYLAXIS

7. Avoidance of mosquitoes and contact with fresh blood from dead domestic animals and respiratory protection from small particle aerosols are the mainstays of prevention. An effective inactivated vaccine is available in limited quantities. The dose is one ml given sc on days zero, seven and 28; exact timing is not critical. Protective antibodies begin to appear within 10–14 days and last for a year, at which time a one ml booster should be given. A single

injection probably is not protective, but two inoculations may provide marginal short-term protection. Ribavirin prophylaxis (400 mg q 8 h) of a related sandfly fever virus was successful, but the dose used might be expected to produce anaemia and other effects in some recipients. The utility of lower doses has not been determined. Interferon alpha in doses not expected to be reactogenic in humans ($5 \times 10^3 - 5 \times 10^4$ U/kg daily) is preventive in monkeys and might be considered for post-exposure prophylaxis in humans.

SMALLPOX

CLINICAL SYNDROME

1. Smallpox virus, an orthopoxvirus with a narrow host range confined to humans, was an important cause of morbidity and mortality in the developing world until recent times. Eradication of the natural disease was completed in 1977 and the last human cases (laboratory infections) occurred in 1978. The virus exists today in only two laboratory repositories in the U.S. and Russia. Appearance of human cases outside the laboratory would signal use of the virus as a biological weapon. Under natural conditions, the virus is transmitted by direct (face to face) contact with an infected case, by fomites, and occasionally by aerosols. Smallpox virus is highly stable and retains infectivity for long periods outside of the host. A related virus, monkeypox, clinically resembles smallpox and causes sporadic human disease in West and Central Africa.

Clinical Features

2. The incubation period is typically 12 days (range, 10–17 days). The illness begins with a prodrome lasting two to three days, with generalised malaise, fever, rigors, headache, and backache. This is followed by defervescence and the appearance of a typical skin eruption characterised by progression over seven to ten days of lesions through successive stages, from macules to papules to vesicles to pustules. The latter finally form crusts and, upon healing, leave depressed depigmented scars. The distribution of lesions is centrifugal (more numerous on face and extremities than on the trunk). Lesions are in the same stage of development at any point in time. Fever may reappear around the seventh day after onset of rash. The case fatality rate is approximately 35 per cent in unvaccinated individuals. A subset of patients develop a haemorrhagic diathesis with disseminated intravascular coagulopathy and have a poor prognosis. Other complications include arthritis, pneumonia, bacterial superinfection of skin lesions, osteomyelitis, and keratitis. Permanent joint deformities and blindness may follow recovery. Vaccine immunity may prevent or modify illness. Fully immune individuals exposed to the virus by the respiratory route may develop fever, sore throat, and conjunctivitis ('contact fever') lasting several days.

DIAGNOSIS

Routine Laboratory Findings

3. Leucopenia is frequently present in severe cases of smallpox. The differential count shows granulocytopenia and a relative increase in lymphocytes. In the early haemorrhagic form, with onset of bleeding before the eruption, severe thrombocytopenia, global reduction in clotting factors, and circulating antithrombin are present, as well as a marked increase in immature lymphoid cells in the peripheral blood, sometimes mistaken for acute leukemia.

Differential Diagnosis

4. The eruption of chickenpox (varicella) is typically centripetal in distribution (worse on trunk than face and extremities) and characterised by crops of

lesions in different stages on development. Chickenpox papules are soft and superficial, compared to the firm, shotty, and deep papules of smallpox. Chickenpox crusts fall off rapidly and usually leave no scar. Monkeypox cannot be easily distinguished from smallpox clinically, although generalised lymphadenopathy is a more common feature of the disease. Monkeypox occurs only in forested areas of West and Central Africa as a sporadic, zoonotic infection transmitted to humans from wild squirrels. Person to person spread is rare and ceases after one to two generations. Mortality is 15 per cent. Other diseases that are sometimes confused with smallpox include typhus, secondary syphilis, and malignant measles.

Specific Laboratory Diagnosis

5. Skin samples (scrapings from papules, vesicular fluid, pus, or scabs) may provide a rapid identification of smallpox by direct electron microscopy, agar gel immunoprecipitation, or immunofluorescence. Virus may be recovered from these samples or blood by inoculation of eggs or cell cultures, but culture techniques require several days. Serological tests may be useful for confirmation, or early presumptive diagnosis.

THERAPY

Chemotherapy

6. There is no specific treatment available although some evidence suggests that vaccinia-immune globulin may be of some value in treatment if given early in the course of the illness. The anti-viral drug, n - methylisatin β -thiosemicarbazone (Marboran (r)) is not thought to be of any therapeutic value.

PROPHYLAXIS

7. Vaccinia virus is a live poxvirus vaccine that induces strong cross-protection against smallpox for at least 5 years and partial protection for 10 years or more. The vaccine is administered by dermal scarification or intradermal jet injection; appearance of a vesicle or pustule within several days is indication of a 'take'. Contraindications to vaccination are pregnancy, clinical immunosuppression, eczema, or leukemia/lymphoma. Complications are infrequent, but include:
 - progressive vaccinia in immunosuppressed individuals (case-fatality >75 per cent);
 - eczema vaccinatum in persons with eczema or a history of eczema, or in contacts with eczema (case-fatality 10–15 per cent);
 - postvaccinal encephalitis, almost exclusively seen after primary vaccination, occurring at an incidence of about 1/500,000, with a case-fatality rate of 25 per cent;
 - generalised vaccinia, seen in immunocompetent individuals and having a good prognosis; and

- autoinnoculation of the eye or genital area, with a secondary lesion.
8. Vaccinia-immune human globulin at a dose of 0.3 mg/kg body weight provides (70 per cent protection against naturally occurring smallpox if given during the early incubation period. Administration immediately after or within the first 24 hours of exposure would provide the highest level of protection, especially in unvaccinated persons.
 9. If vaccinia-immune globulin is unavailable, vaccination or revaccination should be performed as early as possible after (and within 24 hours of) exposure, with careful surveillance for signs of illness.
 10. The anti-viral drug, n-methylisatin β -thiosemicarbazone (Marboran(r)) afforded protection in some early trials, but not others, possibly because of non-compliance due to unpleasant gastrointestinal side effects. Critical review of the published literature suggests a possible protective effect among unvaccinated contacts of naturally infected individuals.
 11. Quarantine, Disinfection: Patients with smallpox should be treated by vaccinated personnel using universal precautions. Objects in contact with the patient, including bed linens, clothing, ambulance, etc, require disinfection by fire, steam, or sodium hypochlorite solution.

TULAREMIA

CLINICAL SYNDROME

1. Tularemia is a zoonotic disease caused by *Francisella tularensis*, a gram-negative bacillus. Humans acquire the disease under natural conditions through inoculation of skin or mucous membranes with blood or tissue fluids of infected animals, or bites of infected deerflies, mosquitoes, or ticks. Less commonly, inhalation of contaminated dusts or ingestion of contaminated foods or water may produce clinical disease. A BW attack with *F. tularensis* delivered by aerosol would primarily cause typhoidal tularemia, a syndrome expected to have a case fatality rate which may be higher than the five to ten per cent seen when disease is acquired naturally.

Clinical Features

2. A variety of clinical forms of tularemia are seen, depending upon the route of inoculation and virulence of the strain. In humans, as few as 10–50 organisms will cause disease if inhaled or injected intradermally, whereas 10⁸ organisms are required with oral challenge. Under natural conditions, ulceroglandular tularemia generally occurs about three days after intradermal inoculation (range two to ten days), and manifests as regional lymphadenopathy, fever, chills, headache, and malaise, with or without a cutaneous ulcer. In those five to ten per cent of cases with no visible ulcer, the syndrome may be known as glandular tularemia. Primary ulceroglandular disease confined to the throat is referred to as pharyngeal tularemia. Oculoglandular tularemia occurs after inoculation of the conjunctivae with a hand or fingers contaminated by tissue fluids from an infected animal. Gastrointestinal tularemia occurs after drinking contaminated ground water, and is characterised by abdominal pain, nausea, vomiting, and diarrhoea.
3. Bacteremia probably is common after primary intradermal, respiratory, or gastrointestinal infection with *F. tularensis*, and may result in septicemic or 'typhoidal' tularemia. The typhoidal form also may occur as a primary condition in five to 15 per cent of naturally-occurring cases; clinical features include fever, prostration, and weight loss, but without adenopathy. Diagnosis of primary typhoidal tularemia is difficult, as signs and symptoms are non-specific and there frequently is no suggestive exposure history. Pneumonic tularemia is a severe atypical pneumonia that may be fulminant, and can be primary or secondary. Primary pneumonia may follow direct inhalation of infectious aerosols, or may result from aspiration of organisms in cases of pharyngeal tularemia. Pneumonic tularemia causes fever, headache, malaise, substernal discomfort, and a non-productive cough; radiologic evidence of pneumonia or mediastinal lymphadenopathy may or may not be present.
4. A biological warfare attack with *F. tularensis* would most likely be delivered by aerosol, causing primarily typhoidal tularemia. Many exposed individuals would develop pneumonic tularemia (primary or secondary), but clinical pneumonia may be absent or non-evident. Case fatality rates may be higher than the five to ten per cent seen when disease is acquired naturally.

DIAGNOSIS

Differential Diagnosis

5. The clinical presentation of tularemia may be severe, yet non-specific. Differential diagnoses include typhoidal syndromes (eg salmonella, rickettsia, malaria) or pneumonic processes (eg plague, mycoplasma, SEB). A clue to the diagnosis of tularemia delivered as a BW agent might be a large number of temporally clustered patients presenting with similar systemic illnesses, a proportion of whom will have a non-productive pneumonia.

Specific Laboratory Diagnosis

6. Identification of organisms by staining ulcer fluids or sputum is generally not helpful. Routine culture is difficult, due to unusual growth requirements and/or overgrowth of commensal bacteria. The diagnosis can be established retrospectively by serology.

THERAPY

7. Streptomycin (1 g q 12 IM for 10–14 days) is the treatment of choice. Gentamicin also is effective (3–5 mg/kg/day parenterally for 10–14 days). Tetracycline and chloramphenicol treatment are effective as well, but are associated with a significant relapse rate. Although laboratory-related infections with this organism are very common, human-to-human spread is unusual and isolation is not required.

PROPHYLAXIS

8. A live, attenuated tularemia vaccine is available as an investigational new drug (IND). This vaccine has been administered to more than 5000 persons without significant adverse reactions and is of proven effectiveness in preventing laboratory-acquired typhoidal tularemia. Its effectiveness against the concentrated bacterial challenge expected in a BW attack is unproven. The use of antibiotics for prophylaxis against tularemia is controversial.

VENEZUELAN EQUINE ENCEPHALITIS

CLINICAL SYNDROME

1. Eight serologically distinct viruses belonging to the Venezuelan equine encephalitis (VEE) complex have been associated with human disease; the most important of these pathogens are designated subtype 1, variants A, B and C. These agents also cause severe disease in horses, mules, and donkeys (Equidae). Natural infections are acquired by the bites of a wide variety of mosquitoes; Equidae serve as the viremic hosts and source of mosquito infection. In natural human epidemics, severe and often fatal encephalitis in Equidae always precedes that in humans. A BW attack with virus disseminated as an aerosol would cause human disease as a primary event. If Equidae were present, disease in these animals would occur simultaneously with human disease. Secondary spread by person to person contact occurs at a negligible rate. However, a BW attack in a region populated by Equidae and appropriate mosquito vectors could initiate an epizootic/epidemic.

Clinical Features

2. Nearly 100 per cent of those infected suffer an overt illness. After an incubation period of one to five days, onset of illness is extremely sudden, with generalised malaise, spiking fever, rigors, severe headache, photophobia, myalgia in the legs and lumbosacral area. Nausea, vomiting, cough, sore throat, and diarrhoea may follow. This acute phase lasts 24–72 hours. A prolonged period of aesthenia and lethargy may follow, with full health and activity regained only after one to two weeks. Approximately four per cent of patients during natural epidemics developed signs of central nervous system infection, with meningismus, convulsions, coma, and paralysis. These neurologic cases are seen almost exclusively in children. The overall case fatality rate is less than one per cent, but in children with encephalitis, it may reach 20 per cent. Permanent neurological sequelae are reported in survivors. Aerosol infection does not appear to increase the likelihood of CNS disease. A VEE infection during pregnancy may cause encephalitis in the fetus, placental damage, abortion, or severe congenital neuroanatomical anomalies.

DIAGNOSIS

Routine Laboratory Findings

3. The white blood cell count shows a striking leukopenia and lymphopenia. In cases with encephalitis, the cerebrospinal fluid may be under increased pressure and contain up to 1000 white cells/mm³ (predominantly mononuclear cells) and mildly elevated protein concentration.

Differential Diagnosis

4. An outbreak of VEE may be difficult to distinguish from influenza on clinical grounds. Clues to the diagnosis are the appearance of a small proportion of

neurological cases or disease in Equidae, but these might be absent in a BW attack.

Specific Laboratory Diagnosis

5. Viremia during the acute phase of illness is generally high enough to allow detection by antigen-capture enzyme immunoassay. Virus isolation may be made from serum, and in some cases throat swab specimens, by inoculation of cell cultures. A variety of serological tests are applicable, including the IgM ELISA, indirect FA, hemagglutination inhibition, complement fixation, and neutralization. For persons without prior exposure to VEE complex viruses in tropical areas, a presumptive diagnosis may be made by finding antibody in a single serum sample taken five to seven days after onset of illness.

THERAPY

6. There is no specific therapy. Patients with uncomplicated VEE infection may be treated with analgesics to relieve headache and myalgia. Patients who develop encephalitis may require anticonvulsant and intensive supportive care to maintain fluid and electrolyte balance, adequate ventilation, and to avoid complicating secondary bacterial infections.

PROPHYLAXIS

7. Vaccine. An experimental vaccine, designated TC-83 is a live, attenuated cell-culture-propagated vaccine which has been used in several thousand persons to prevent laboratory infections. The vaccine is given as a single 0.5 ml subcutaneous dose. Febrile reactions occur in up to 18 per cent of persons vaccinated, and may be moderate to severe in five per cent, with fever, myalgia, headache, and prostration. Approximately 10 per cent of vaccinees fail to develop detectable neutralising antibodies, but it is unknown whether they are susceptible to clinical infection if challenged. Non-responders may be revaccinated with TC-83. Contraindications for use include an intercurrent viral infection or pregnancy. TC-83 is a licensed vaccine for Equidae.
8. A second investigational product that has been tested in humans is the C-84 vaccine, prepared by formalin-inactivation of the TC-83 strain. The vaccine is presently not recommended for primary immunisation, on the basis of animal studies indicating that it may not protect against aerosol infection. However, it may be useful for aerosol protection for persons not responding to TC-83 (0.5 ml subcutaneously at two to four week intervals for up to three inoculations or until an antibody response is measured.)
9. Antiviral Drugs. In experimental animals, alpha-interferon and the interferon-inducer poly-ICLC have proven highly effective for post-exposure prophylaxis of VEE. There are no clinical data on which to assess efficacy in humans.

CHAPTER 20

TOXINS — MEDICAL MANAGEMENT

1. Toxins behave as chemical agents, however, the custom in international defence forces is to deal with them under the heading of biological as they are derived from living organisms. For the purposes of this document the management protocols have been moved to their own chapter for simplicity. Their use is similar to that for biological incidents, however, some have been used as weapons directed specifically against an individual.

Toxins

2. Toxins are poisonous substances produced and derived from living plants, animals, or micro-organisms; some toxins may also be produced or altered by chemical means. Toxins may be countered by specific antisera and selected pharmacologic agents.

Antitoxin Therapy

3. Specific antitoxins are available for certain conditions. Where applicable, specific guidelines are included in Annexes to this chapter. No broad-spectrum antitoxins currently exist.

Annexes:

- A. Examples of Toxins
- B. Botulinum Toxins
- C. Clostridium Perfringens Toxins
- D. Ricin
- E. Saxitoxin
- F. Staphylococcal Enterotoxin B (Seb)
- G. Trichothecene Mycotoxins

EXAMPLES OF TOXINS

Toxin	Produced By	Symptoms	Remarks
Staphylococcal Enterotoxin	Bacteria	Headache, nausea and vomiting, diarrhoea (severe prostration)	Symptoms within 648 hrs
Botulinum Toxin	Bacteria	General weakness, double vision, dizziness, weakness of muscles	80% lethal without Resp support
Trichothecene Mycotoxin	Fusaria species of fungi	Nausea, vomiting, blood filled blisters, internal blisters	5% lethal
Cobra Neurotoxin	Cobra	Numbness, tiredness, clouding of consciousness, dimming of vision, weakness of muscles, paralysis of breathing	Lethal
Palytoxin	Marine corals	Cardiac arrest due to constriction of blood supply	Lethal
Ricin	Castor oil plant And seeds	Abdominal pain, fever, burning in throat, convulsions, collapse	Lethal
Tetrodotoxin	Puffer fish	Muscular weakness, collapse	Lethal

BOTULINUM TOXINS

CLINICAL SYNDROME

1. Botulism is caused by intoxication with any of the seven distinct neurotoxins produced by the bacillus, *Clostridium botulinum*. The toxins are proteins with molecular weights of approximately 150 000, which bind to the presynaptic membrane of neurons at peripheral cholinergic synapses to prevent release of acetylcholine and block neurotransmission. The blockade is most evident clinically in the cholinergic autonomic nervous system and at the neuromuscular junction. A biological warfare attack with botulinum toxin delivered by aerosol would be expected to cause symptoms similar in most respects to those observed with food-borne botulism.

Clinical Features

2. Symptoms of inhalation botulism may begin as early as 24–36 hours following exposure, or as late as several days. Initial signs and symptoms include ptosis, generalised weakness, lassitude, and dizziness. Diminished salivation with extreme dryness of the mouth and throat may cause complaints of a sore throat. Urinary retention or ileus may also occur. Motor symptoms usually are present early in the disease; cranial nerves are affected first with blurred vision, diplopia, ptosis, and photophobia. Bulbar nerve dysfunction causes dysarthria, dysphonia, and dysphagia. This is followed by a symmetrical, descending, progressive weakness of the extremities along with weakness of the respiratory muscles. Development of respiratory failure may be abrupt. On physical examination, the patient is alert, oriented, and afebrile. Postural hypotension may be present. Ocular findings may include ptosis, extracellular muscle paralysis, and fixed and dilated pupils. Mucous membranes of the mouth may be dry and crusted. Neurological examination shows flaccid muscle weakness of the palate, tongue, larynx, respiratory muscles, and extremities. Deep tendon reflexes vary from intact to absent. No pathologic reflexes are present, and the sensory examination generally is normal (although reports suggest that obtundation or sensory involvement may sometimes occur).

DIAGNOSIS

Routine Findings

3. Routine laboratory findings are of no value in diagnosis. The cerebrospinal fluid is normal.

Differential Diagnosis

4. The occurrence of an epidemic with large numbers of afebrile patients with progressive ocular, pharyngeal, respiratory, and muscular weakness and paralysis hints strongly at the diagnosis. Single cases may be confused with various neuromuscular disorders such as atypical Guillain-Barré syndrome, myasthenia gravis, or tick paralysis. The edrophonium (tensilon) test may be

transiently positive in botulism. Other considerations include enteroviral infections; but in these patients, fever is present, paralysis is often asymmetrical, and the cerebrospinal fluid is abnormal. It may be necessary to distinguish nerve agent and atropine poisoning from botulinum intoxication. Briefly, organophosphate nerve agent poisoning results in miotic pupils and copious secretions. In atropine poisoning, the pupils are dilated and mucous membranes are dry, but central nervous system excitation with hallucinations and delirium is present. (See Annex D for a more comprehensive differential).

Specific Laboratory Findings

5. Detection of toxin in serum or gastric contents from cases of food-borne botulism is often feasible by mouse inoculation. Toxin has also been detected in serum following inhalation exposure in experimental animals. Serum should be obtained from representative cases for such attempts. Survivors probably will not develop an antibody response due to the small amount of toxin necessary to cause death.

THERAPY

6. Respiratory failure secondary to paralysis of respiratory muscles is the most serious complication and, generally, the cause of death. Reported cases of botulism prior to 1950 had a mortality of 60 per cent. With tracheostomy and ventilatory assistance, fatalities should be less than five per cent. Intensive and prolonged nursing care may be required for recovery (which may take several weeks or even months).

Antitoxin

7. In isolated cases of food-borne botulism, circulating toxin is usually present, perhaps due to continued absorption through the gut wall. Equine antitoxin has been used in these circumstances, and is probably helpful. After aerosol exposure, antitoxin can be effective, sometimes even after onset of signs of intoxication. Administration of antitoxin is reasonable if disease has not progressed to a stable state. **In the civilian setting the antitoxin is not available and is not useful in established paralysis.**
8. There is no prospect for additional human antitoxin to be produced. A 'despecciated' equine heptavalent antitoxin (vs types A, B, C, D, E, F, and G) has been prepared by cleaving the Fc fragments from horse IgG molecules, leaving F(ab)₂ fragments. Its efficacy is inferred from its performance in animal studies. Use requires pretesting for sensitivity to horse serum (and desensitisation for those allergic). Disadvantages include rapid clearance by immune elimination, as well as a theoretical risk of serum sickness.

PROPHYLAXIS

9. A pentavalent toxoid of *Clostridium botulinum* types A, B, C, D, and E is available under IND status. This product has been administered to several thousand volunteers and occupationally at risk workers, and induces serum

antitoxin levels that correspond to protective levels in experimental animal systems. The currently recommended schedule (zero, two and 12 weeks, then a one year booster) induces solidly protective antitoxin levels in greater than 90 per cent of vaccines after one year. Contraindications include sensitivity to alum, formaldehyde, and thimerosal, or hypersensitivity to a previous dose. Reactogenicity is mild, with two to four per cent of vaccines reporting erythema, oedema, or induration which peaks at 24–48 hours, then dissipates. The frequency of local reactions increases with each subsequent inoculation; after the second and third doses, seven to ten per cent will have local reactions, with higher incidence (up to 20 per cent or so) after boosters. Severe local reactions are rare, consisting of more extensive oedema or induration. Systemic reactions are reported in up to three per cent, consisting of fever, malaise, headache, and myalgia. Incapacitating reactions (local or systemic) are uncommon. The vaccine should be stored at refrigerator temperatures (not frozen).

10. Three or more vaccine doses (zero, two and 12 weeks, then one year if possible by deep subcutaneous injection) are recommended only to selected individuals or groups judged at high-risk for exposure to botulinum toxin aerosols. There is no indication at present for use of antitoxin as a prophylactic modality except under extremely specialised circumstances. (For example, known impending exposure of small numbers of individuals.)

CLOSTRIDIUM PERFRINGENS TOXINS

CLINICAL SYNDROME

1. *Clostridium perfringens* is a common anaerobic bacterium associated with three distinct disease syndromes; gas gangrene or clostridial myonecrosis; enteritis necroticans (pig-bel); clostridium food poisoning. Each of these syndromes has very specific requirements for delivering inocula of *C. perfringens* to specific sites to induce disease, and it is difficult to imagine a general scenario in which the spores or vegetative organisms could be used as a biological warfare agent. There are, however, at least 12 protein toxins elaborated, and one or more of these could be produced, concentrated, and used as a weapon. Waterborne disease is conceivable, but unlikely. The alpha toxin would be lethal by aerosol. This is a well-characterised, highly toxic phospholipase C. Other toxins from the organism might be co-weaponized and enhance effectiveness. For example, the epsilon toxin is neurotoxic in laboratory animals.

Clinical Features

2. The clinical picture of aerosolized *C. perfringens* alpha toxin would be expected to be that of a serious acute pulmonary insult. Absorbed alpha toxin could produce vascular leak, haemolysis, thrombocytopenia and liver damage. Other toxins admixed could modify the illness. There is insufficient information available to speculate on a clinical syndrome produced by other *C. perfringens* toxins.

DIAGNOSIS

Routine Findings

3. Clinical laboratory findings might include anaemia (due to intravascular haemolysis), thrombocytopenia, elevated serum transaminases, and hypoxia.

Differential Diagnosis

4. Pulmonary findings might lead to confusion with staphylococcal enterotoxin B (SEB) initially. Liver damage, haemolytic anaemia, and thrombocytopenia are not associated with SEB and the pulmonary findings should be reversible in SEB.

Specific Laboratory Diagnosis

5. Acute serum and tissue samples should be collected and rapidly transported to a reference laboratory. Specific immunoassays are available; however, their utility in diagnosis of human disease is unproven. The enterotoxin can be detected in fecal samples from human food poisoning cases, and bacteria are readily cultured from clinical samples.

THERAPY

6. No specific treatment is available for *C. perfringens* intoxication. The organism itself is sensitive to penicillin, and consequently, this is the current drug of choice. Recent data indicate that clindamycin or rifampin may suppress toxin production and provide superior results in animal models.

PROPHYLAXIS

7. There is no available prophylaxis against most *C. perfringens* toxins. Toxoids are being used to prevent enteritis necroticans in humans, and veterinary toxoids are in wide use.

RICIN

CLINICAL SYNDROME

1. Ricin is a glycoprotein toxin (66,000 daltons) from the seed of the castor plant. It blocks protein synthesis by altering the RNA, thus killing the cell. Ricin's significance as a potential biological warfare agent relates to its availability world wide, its ease of production and extreme pulmonary toxicity when inhaled.

Clinical Features

2. Overall, the clinical picture seen depends on the route of exposure. All reported serious or fatal cases of castor bean ingestion have taken approximately the same course: latent period of three to 20 hours, rapid onset of nausea, vomiting, abdominal cramps and severe diarrhoea with vascular collapse; death has occurred on the third day or later. Following inhalation, one might expect non-specific symptoms of weakness, fever, cough, and hypothermia followed by hypotension and cardiovascular collapse. In monkeys, inhalation toxicity is characterised by a dose dependent preclinical period of 24–36 hours followed by anorexia and progressive decrease in physical activity. Death occurs 36–48 hours post challenge. In mice, histopathologic change is characterised by necrotizing, suppurative airways lesions: rhinitis, laryngitis, tracheitis, bronchitis, bronchiolitis and interstitial pneumonia with perivascular and alveolar oedema. Histopathologic change in the airways is seen as early as three hours post challenge. The exact cause of death is unknown and probably varies with route of intoxication. High doses by inhalation appear to produce severe enough pulmonary damage to cause death. **It would be unlikely be confused with other toxins, however, other poisons could produce a similar picture not to mention overwhelming sepsis.**

DIAGNOSIS

Routine Laboratory Findings

3. Laboratory findings are generally non-specific. Neutrophilic leucocytosis beginning between 12–18 hours was reported in a case of human lethal intramuscular intoxication that was purposely inflicted. Leucocytosis, beginning 12–18 hours after challenge, also occurs following aerosol exposure of laboratory animals.

Differential Diagnosis

4. In oral intoxication, fever, gastrointestinal involvement and vascular collapse are prominent, the latter differentiating it from infection with enteric pathogens. With regard to inhalation exposure, non-specific findings of weakness, fever, vomiting, cough, hypothermia and hypotension in large numbers of patients might suggest several respiratory pathogens. The temporal onset of botulinum intoxication would be similar, but include ptosis and general muscular paralysis with minimal pulmonary effects. Staphylococcal enterotoxin B intoxication would

likely have a more rapid onset after exposure and a lower mortality rate, but could be difficult to distinguish. Nerve agent intoxication is characterised by acute onset of cholinergic crisis with dyspnea and profuse secretions.

Specific Laboratory Diagnosis

5. Based on animal studies, ELISA (for blood) or immunohistochemical techniques (for direct analysis of tissues) may be useful in confirming ricin intoxication. Post mortem pathologic change is route specific: inhalation results in airways lesions; ingestion causes gastrointestinal haemorrhage with necrosis of liver, spleen and kidneys; and intramuscular intoxication causes severe local muscle and regional lymph node necrosis with moderate involvement of visceral organs. Ricin is extremely immunogenic; sera should be obtained from survivors for measurement of antibody response.

THERAPY

6. Management is supportive and should include maintenance of intravascular volume. Standard management for poison ingestion should be employed if intoxication is by the oral route. There is presently no antitoxin available for treatment.

PROPHYLAXIS

7. There is currently no prophylaxis approved for human use. Active immunisation and passive antibody prophylaxis are under study, as both are effective in protecting animals from death following exposure by intravenous or respiratory routes. Ricin is not dermally active, therefore respiratory protection is the most critical means of prevention.

SAXITOXIN

CLINICAL SYNDROME

1. Saxitoxin is the parent compound of a family of chemically related neurotoxins. In nature they are predominantly produced by marine dinoflagellates, although they have also been identified in association with such diverse organisms as blue green algae, crabs, and the blue-ringed octopus. Human intoxications are principally due to ingestion of bivalve molluscs which have accumulated dinoflagellates during filter feeding. The resulting intoxication, known as paralytic shellfish poisoning (PSP), is known throughout the world as a severe, life-threatening illness requiring immediate medical intervention.
2. Saxitoxin and its derivatives are water-soluble compounds that bind to the voltage-sensitive sodium channel, blocking propagation of nerve-muscle action potentials. Consistent with this mechanism of action, victims typically present with neurological symptoms and in severe cases, death results from respiratory paralysis.
3. The natural route of exposure to these toxins is oral. In a BW scenario, the most likely route of delivery is by inhalation or toxic projectile. In addition, saxitoxin could be used in a confined area to contaminate water supplies.

Clinical Features

4. After oral exposure, absorption of toxins from the gastrointestinal tract is rapid. Onset of symptoms typically begins 10–60 minutes after exposure, but may be delayed several hours depending upon the dose and individual idiosyncrasy. Initial symptoms are numbness or tingling of the lips, tongue and fingertips, followed by numbness of the neck and extremities and general muscular incoordination. Nausea and vomiting may be present, but typically occur in a minority of cases. Other symptoms may include a feeling of light headedness, or floating, dizziness, weakness, aphasia, incoherence, visual disturbances, memory loss and headache. Cranial nerves are often involved, especially those responsible for ocular movements, speech, and swallowing. Induced reflexes are normal and the patient remains conscious. Respiratory distress and flaccid muscular paralysis are the terminal stages and can occur two to 12 hours after intoxication. Death results from respiratory paralysis. Clearance of the toxin is rapid and survival for 12–24 hours usually indicates recovery. Complete recovery may require seven to 14 days. There are no known cases of inhalation exposure to saxitoxin in the medical literature, but data from animal experiments suggest the entire syndrome is compressed and death may occur in minutes.

DIAGNOSIS

Routine Laboratory Findings

6. Routine laboratory evaluation is not particularly helpful. Cardiac conduction defects may develop. Elevation of serum creatine kinase levels in some patients has been reported.

Differential Diagnosis

7. Exposure to tetrodotoxin or the ciguatera toxins can manifest very similar signs and symptoms. Ciguatoxins (by oral exposure) typically demonstrate a much greater degree of gastrointestinal involvement, and can also be differentiated by a history of eating finfish rather than shellfish. Tetrodotoxin intoxication is nearly identical to that caused by the saxitoxins except that hypotension typically plays a greater role in severe intoxication. Differential diagnosis may require toxin detection. Gas chromatographic analysis of food or stomach contents can rule out pesticide exposure.

Specific Laboratory Tests

8. Diagnosis is confirmed by detection of toxin in the food, water, stomach contents or environmental samples. Saxitoxin, neosaxitoxin, and several other derivatives can be detected by enzyme-linked immunosorbant assay (ELISA) or by mouse bioassay. Specific toxins can be differentiated by HPLC. The Association of Official Analytical Chemists has adopted an official method for mouse bioassay for the analysis of seafood.

THERAPY

9. Management is supportive and standard management of poison ingestion should be employed if intoxication is by the oral route. Toxins are rapidly cleared and excreted in the urine, so diuresis may increase elimination. Charcoal hemoperfusion has been advocated, but remains unproven in its utility. Intubation and mechanical respiratory support may be required in severe intoxication. Timely resuscitation would be imperative, albeit very difficult, after inhalation exposure on the battlefield. Specific antitoxin therapy has been successful in animal models, but is untested in humans.

PROPHYLAXIS

10. No vaccine against saxitoxin exposure has been developed for human use.

STAPHYLOCOCCAL ENTEROTOXIN B (SEB)

CLINICAL SYNDROME

1. Staphylococcal enterotoxin B (SEB) is one of several exotoxins produced by *Staphylococcus aureus*, causing food poisoning when ingested. A BW attack with aerosol delivery of SEB to the respiratory tract produces a distinct syndrome causing significant morbidity and potential mortality.

Clinical Features

2. The disease begins one to six hours after exposure with the sudden onset of fever, chills, headache, myalgia, and non-productive cough. In more severe cases, dyspnea and retrosternal chest pain may also be present. Fever, which may reach 39 – 40°C, has lasted two to five days, but cough may persist one to four weeks. In many patients nausea, vomiting, and diarrhoea will also occur. Physical findings are often unremarkable. Conjunctival injection may be present, and in the most severe cases, signs of pulmonary oedema would be expected. The chest x-ray is generally normal, but in severe cases, there will be increased interstitial markings, atelectasis, and possibly overt pulmonary oedema. In moderately severe laboratory exposures, lost duty time has been less than two weeks, but, based upon animal data, it is anticipated that severe exposures will result in fatalities.

DIAGNOSIS

Routine Laboratory Findings

3. Laboratory findings are non-contributory except for a neutrophilic leucocytosis and elevated erythrocyte sedimentation rate.

Differential Diagnosis

4. In foodborne SEB intoxication, fever and respiratory involvement are not seen, and gastrointestinal symptoms are prominent. The non-specific findings of fever, non-productive cough, myalgia, and headache occurring in large numbers of patients in an epidemic setting would suggest any of several infectious respiratory pathogens, particularly influenza, adenovirus, or mycoplasma. In a BW attack with SEB, cases would likely have their onset within a single day, while naturally occurring outbreaks would present over a more prolonged interval. Naturally occurring outbreaks of Q fever and tularemia might cause confusion, but would involve much smaller numbers of individuals, and would more likely be accompanied by pulmonary infiltrates.
5. The dyspnea of botulism is associated with obvious signs of muscular paralysis: its cholinergic blocking effects result in a dry respiratory tree, and patients are afebrile. Inhalation of nerve agent will lead to weakness, dyspnea, and copious secretions. The early clinical manifestations of inhalation anthrax, tularemia, or plague may be similar to those of SEB. However, rapid progression of

respiratory signs and symptoms to a stable state distinguishes SEB intoxication. Mustard exposure would have marked vesication of the skin in addition to the pulmonary injury.

Specific Laboratory Diagnosis

6. Toxin is cleared from the serum rapidly and is difficult to detect by the time of symptom onset. Nevertheless, specific laboratory tests are available to detect SEB, and serum should be collected as early as possible after exposure. In situations where many individuals are symptomatic, sera should be obtained from those not yet showing evidence of clinical disease. Most patients develop a significant antibody response, but this may require two to four weeks.

THERAPY

7. Treatment is limited to supportive care. No specific antitoxin for human use is available.

PROPHYLAXIS

8. There currently is no prophylaxis for SEB intoxication. Experimental immunisation has protected monkeys, but no vaccine is presently available for human use.

TRICHOHECENE MYCOTOXINS

CLINICAL SYNDROME

1. The trichothecene mycotoxins are a diverse group of more than 40 compounds produced by fungi. They are potent inhibitors of protein synthesis, impair DNA synthesis, alter cell membrane structure and function, and inhibit mitochondrial respiration. Secondary metabolites of fungi, such as T-2 toxin and others, produce toxic reactions called mycotoxicoses upon inhalation or consumption of contaminated food products by humans or animals. Naturally occurring trichothecenes have been identified in agricultural products and have been implicated in a disease of animals known as moldy corn toxicosis or poisoning.
2. There are no well-documented cases of clinical exposure of humans to trichothecenes. However, strong circumstantial evidence has associated these toxins with alimentary toxic aleukia (ATA), the fatal epidemic seen in Russia during World War II. There are also alleged BW incidents ('yellow rain') in Cambodia, Laos and Afghanistan.

Clinical Features

3. Consumption of these mycotoxins results in weight loss, vomiting, skin inflammation, bloody diarrhoea, diffuse haemorrhage, and possibly death. Clinical signs in experimental animals (calves) given 0.08–0.64 mg T-2/kg/day for nine days included loss of appetite, weight loss, an increase in prothrombin time, and an increased serum aspartate amino transferase level. The onset of illness following acute exposure to T-2 (IV or inhalation) occurs in hours, resulting in the rapid onset of circulatory shock characterised by reduced cardiac output, arterial hypotension, lactic acidosis and death within 12 hours.
4. Clinical signs and symptoms of ATA were haemorrhage, leukopenia, ulcerative pharyngitis, and depletion of bone marrow. The purported use of T-2 as a BW agent resulted in an acute exposure via inhalation and/or dermal routes, as well as oral exposure upon consumption of contaminated food products and water. Alleged victims reported painful skin lesions, lightheadedness, dyspnea, and a rapid onset of haemorrhage, incapacitation and death. Survivors developed a radiation-like sickness including fever, nausea, vomiting, diarrhoea, leukopenia, bleeding, and sepsis.

DIAGNOSIS

Routine Laboratory Findings

5. Hematological alterations in the rodent model (parenteral routes) include marked but transient leucocytosis, characterised by rapid lymphocytosis and a mild neutrophilia. This is followed by a leukopenia that returns to normal values four to seven days post-exposure. There is a reduced hematocrit with the presence of nucleated erythrocytes. Serum proteins and enzymes are not significantly altered after this acute exposure.

Differential Diagnosis

6. Other diagnoses to consider include radiation toxicity and plant or chemical toxicity.

Specific Laboratory Diagnosis

7. Specific diagnostic modalities are limited to reference laboratories. Gas-liquid chromatography (GC) and high pressure liquid chromatography (HPLC) have been used for detecting T-2 and related trichothecene mycotoxins in plasma and urine. Polyclonal and monoclonal antibodies to trichothecenes are also available for detection in liquid or solid samples after solvent extraction. Because of their long 'half-life' the toxin metabolites can be detected as late as 28 days after exposure. Between 50–75 per cent of the parent toxin and metabolites are eliminated in urine and faeces within 24 hours. Urine should be the biological fluid chosen for diagnostic purposes. A one time urine sample with 0.10cc concentrated hydrochloric acid added per 100cc of urine, to kill unwanted bacteria, should be submitted for analysis if the exposure was a recent one. Trichothecene Mycotoxins can be detected in the urine out to approximately 14 days after exposure but if several days have elapsed since exposure a 24- hour urine collection with HCl added should be submitted instead of a one time collection. The urine does not need to be kept refrigerated.

THERAPY

8. General supportive measures are used to alleviate acute T-2 toxicoses. Prompt (within 5–60 min of exposure) soap and water wash significantly reduces the development of the localised destructive, cutaneous effects of the toxin. After oral exposure management should include standard therapy for poison ingestion. Of note is that a Superactivated Charcoal (such as Superchar, Gulf Bio Systems, Inc, Dallas, TX)/may offer an advantage over regular activated charcoal in that one needs to see approximately five times the dose of activated charcoal to gain an equivalent outcome to that if Superchar is used. Superactivated charcoal is becoming standard in emergency management of poison ingestion. This substance has an extremely large surface area, two to three times that of regular activated charcoal. Superchar oral treatment (1–7 g/kg, po) either immediately or one to three hours after toxin exposure significantly increases survival times of animals. Some benefit may be derived

from giving activated charcoal as late as five hours after exposure to T-2 toxins. In animal studies, dexamethasone (1– 10 mg/kg, IV) administered as late as three hours after exposure to T-2 toxin improved survival and reduced the incidence of massive bloody diarrhoea. No antitoxin is presently available for human use.

PROPHYLAXIS

9. Ascorbic acid (400–1200 mg/kg, ip) works to decrease lethality in animal studies, but has not been tested in humans. While not yet available for humans, administration of large doses of monoclonal antibodies directed against T-2 and metabolites have shown prophylactic and therapeutic efficacy in animal models.

CHAPTER 21

SUMMARY OF CHARACTERISTICS OF CHEMICAL AGENTS

DEFINITIONS

1. The following definitions are used in this document:

- **Chemical Agent**—A chemical substance intended for use in military operations to kill, seriously injure, or incapacitate man through its physiological effects. (smoke, flame, riot control agents and herbicides are excluded from this definition).
- **Concentration**—The amount of chemical agent in a unit volume, unit of measure is normally (mg/m^3).
- **Dosage**—The concentration of chemical agent in the atmosphere multiplied by the time the concentration remains, unit of measure is normally ($\text{mg}\cdot\text{min}/\text{m}^3$).
- **Hydrolysis**—The reaction of any chemical with water whereby decomposition of the chemical occurs and one or more new substances are produced.
- **Rate of Detoxification**—The rate at which the body is able to counter act and neutralise the effects of a poisonous substance.
- **Rate of Action**—This indicates how long the agent will take for its full effects (lethal or incapacitating) to take effect.
- **Median Incapacitating Dose or ICT_{50}** —The amount of inhaled vapour or aerosol (dosage) that is sufficient to incapacitate or disable 50 per cent of the exposed unprotected personnel.
- **Median Lethal Dose or LCT_{50}** —The amount of inhaled vapour or aerosol (dosage) that is lethal to 50 per cent of the exposed unprotected personnel.
- **Duration of Effectiveness**—The amount of time a chemical agent exists at the point of dissemination. Its is determined by:
 - physical properties of the agent;
 - weather conditions;
 - method of dissemination; and
 - conditions of terrain or target.

- **Density**—The weight of a chemical vapour relative to that of air. Air is equal to 1, therefore a chemical agent with a vapour density of 9.2 means that it is heavier than air.

GENERAL CHARACTERISTICS AND EFFECTS (See Chapter 22 for detailed information)

Physical State

2. Agents may be disseminated in one or more of the following forms:
 - **Liquid**—As liquid splashes or droplets.
 - **Aerosol**—As fine liquid (eg spray) or solid particles like fog or smoke (however not all aerosols are visible).
 - **Vapour**—In gaseous form.
 - **Solid**—In solid form (eg CS crystals).

Persistence

3. This relates to the duration that chemical agents will remain a hazard. Agents are classified into two groups:
 - Persistent.
 - Non-persistent.

Method of Entry

4. To be effective an agent must enter the body. There are three routes by which agents may do this:
 - **Inhalation**—The agent is breathed in. This is also referred to as the respiratory route.
 - **Adsorption**—Penetration of the skin or eyes. This is referred to as the percutaneous route.
 - **Ingestion**—The agent is swallowed, perhaps with food or water.

Odour

5. Some chemical agents are readily identified by a recognisable odour.

Classification of Chemical Agents

6. Chemical Agents are classified according to the following:
 - Toxicity.
 - Duration of effectiveness.

- Effects on the body.

Toxicity

7. The toxicity classification is to define the primary effect of agents. Agents are classified as follows:
 - **Toxic Agents**—These are delivered with the primary objective of killing, with the exception of blister agents which are primarily used for their incapacitation effect, however they can cause death and are therefore classified toxic.
 - **Non-toxic Agents**—These are further divided into two groups — riot control and incapacitating which will be covered later in this chapter. These agents are designed to cause temporary incapacitation without permanent damage.

Duration and Effectiveness

8. This is measured by the agent's persistency and is either non-persistent or persistent as described below:
 - **Non-persistent**—Gases or liquids which evaporate quickly to give a vapour cloud which moves down-wind, dispersing by diffusion. The duration can last for minutes/ hours/days.
 - **Persistent**—Solids or liquids which remain in the target area, presenting a contact hazard and often evaporating slowly to produce a vapour hazard which can last for days/months/years.

Effects on the Body

9. The third method of classifications is to group agents by their action on the body. These groups are as follows:
 - **Toxic Agents:**
 - *Nerve agents*—These interfere with the nervous system and thus disrupt essential body functions eg breathing, muscular coordination and vision.
 - *Choking agents*—These attack the breathing passages and lungs.
 - *Blood agents*—These prevent body tissues from using the oxygen in the blood.
 - *Blister Agents*—These cause inflammation, blistering of the skin and superficial destruction of contaminated internal tissues eg the lining of breathing passages.
 - **Non-toxic Agents:**

- *Incapacitating Agents*—These cause temporary disabling conditions, which can be physical or mental and can persist for hours or days after exposure to the agent has ceased.
- *Riot Control Agents*—These cause short term disability. Tear agents CS and CN, and the vomiting agent DM fall into this group.

Annex:

A. Chemical Agents Summary

CHEMICAL AGENTS SUMMARY

CHAPTER 22

DETAILED CHARACTERISTICS AND EFFECTS OF CHEMICAL AGENTS

INTRODUCTION

1. The definition of a chemical agent is: A chemical substance which is intended for use in military operations to kill, seriously injure or incapacitate humans because of its physiological effects. Excluded from this definition are riot control agents, herbicides, smoke and flame.
2. Chemical agents in the modern sense were first used in Ypres, France in 1915, when chlorine gas was released from large cylinders. This surprise operation caused massive casualties, demoralisation of the forces attacked and demonstrated the need for protection from this kind of warfare. The first improvised mask was a cotton pad soaked in sodium thiosulphate, glycerine and sodium carbonate. Subsequently in World War I, a great variety of chemical agents were used by both sides, the most damaging being the blister producing sulphur mustard. Military clothing, even with a respirator, gave little protection against this agent. Chemical agents were not used in World War II, but at the end of the war stockpiles of newer agents, called 'nerve gases', were discovered. These were found to be effective in much lower concentrations than those agents known up to that time. The standard of training and preparedness of the 'services' and the fear of retaliation were possible reasons why chemical agents were not used.
3. Between World Wars I and II, mustard gas was used with considerable effect against unprotected troops. Since World War II, there have been several confirmed reports that chemical agents have been used in armed conflicts including the Iran-Iraq conflict.
4. Riot control agents such as CS (tear agent) have been used repeatedly for example in Southeast Asia to support tactical operations: in particular to flush out guerillas from hiding and to render places of concealment untenable. These compounds and other tear agents are frequently used as riot control agents by police forces.
5. The advent of nuclear weapons and the fact that chemical agents were not used in World War II, did not prevent their use in recent conflicts and do not exclude the possibility of their use in a future war. The effectiveness of chemical agents as tactical weapons was clearly demonstrated in World War I and in the Iran-Iraq conflict. They can equally affect both forward and rear areas. It seems probable that the nature and severity of casualties may differ in future from those recorded in World War I.

GENERAL FACTORS INFLUENCING THE EMPLOYMENT AND CHOICE OF CHEMICAL AGENTS

6. The effective use of any chemical agent is dependent on its physical and chemical properties and on meteorological conditions.

Persistency

7. Chemical agents may be divided into two main categories as follows:
 - **Non-persistent Agents**—These disperse rapidly after release and present an immediate, short duration hazard. They are released as airborne particles, liquids and gases, and intoxication usually results from inhalation.
 - **Persistent Agents**—These continue to present a hazard for considerable periods after delivery by remaining as contact hazard or by vaporising over a period to produce a hazard by inhalation. Non-persistent agents may be made persistent by thickening with various substances.

Effectiveness

8. Effectiveness is the capacity of an agent to produce the maximum number of casualties or amount of disruption of operations with the least amount of agent, although other tactical criteria may be used to gauge this effectiveness. 'Effectiveness' is a general term which takes in such criteria as suitability, toxicity, irritancy etc. Effectiveness is also dependent on the ability of the population attacked to neutralise or counter the effects of agents once they have been delivered. The duration of effectiveness depends on the physical characteristics of the agent, the amount of agent delivered, the weapon system used and the terrain and weather in the target area at the time the agent is delivered and later.

Meteorological Influences

9. The following meteorological factors will influence the duration of effectiveness of chemical agents: (refer to Chapter 8 for more detailed information.)
 - **Winds**—The effect of wind is to disperse agents rapidly in open country, however, dangerous concentrations may remain longer in forests, trenches, dug-outs and built-up areas.
 - **Temperature**—High temperatures decrease the persistency of agents and cause higher vapour concentrations. Low temperatures increase the persistency of agents. Some agents may freeze thus reducing the immediate contact hazard. There is a danger of carrying such frozen agents on clothing and equipment into a warm building with the subsequent risk of toxic vapour being given off.
 - **Rainfall**—Rain disposes, dilutes and promotes hydrolysis of agents. This reduces their effectiveness but does not make them impossible to use.

- **Atmospheric Stability**—When the air temperature is higher than that at ground level (a state of inversion), agents in the vapour state will persist for longer periods than when the air temperature is lower than that at ground level (a state of lapse).

GENERAL CHARACTERISTICS

Physical

10. Known agents cover the whole range of physical properties. Under ambient conditions their physical state may be gaseous, liquid or solid. Their vapour pressures vary from high to negligible. Their vapour densities vary from slightly lighter to considerably heavier than air. The range of odours varies from none to highly pungent or characteristic. They may be soluble or insoluble in water. In the following chapters the physical properties of various agents are given in tables at the end of the appropriate chapter. These may give an indication of the behaviour of the agents in the field with regard to vapour hazard, persistency and possible means of decontamination, etc. Agents with a low boiling point and high vapour pressure tend to be non-persistent. Agents with a high boiling point and low volatility tend to be more persistent.

Chemical

11. The only general characteristic of the known agents is that they are sufficiently stable to survive dissemination and transport to the site of their biological action. Their inherent reactivity and stability can vary widely. Some chemically reactive agents denature rapidly, whereas other less reactive agents require, for example, bleach solutions to inactivate them. Solid adsorbents (eg fullers' earth) are very effective decontaminants but do not denature agents and the potential for off-gassing should be recognised.

Toxicological

12. It should be realised that not all individuals of a species react in the same way to a given amount of agent, some being more or less sensitive as a result of many factors, of which genetic background, race and age are examples. Also, toxicological studies estimate the biological effects of potential agents by different routes of exposure. The physical properties of such materials may affect the toxicological studies since the response of the biological system concerned may vary depending on the physical state of the material. Studies of the mode of action are related to the development of medical countermeasures and physical protection devices.

Routes of Absorption

13. Chemical agents may enter the body by several routes and the nature and onset of signs and symptoms may vary accordingly. Examples are as follows:
 - Gases, vapours and aerosols, when inhaled, may be absorbed through any part of the respiratory tract, from the mucosa of the nose and mouth to the alveoli of the lungs. They may also be directly absorbed by the eye.
 - Aerosol particles larger than 5 μm tend to be retained in the upper respiratory tract, while those smaller than 1 μm tend to be breathed in and out again, although some of these smaller particles may be retained.

- Droplets of liquid and, less commonly, solid particles may be absorbed through the surface of the skin and mucous membranes. Toxic compounds with a characteristic action on the skin can produce their effects when deposited on the skin as solid or liquid particles.
- Agents which penetrate the skin may form temporary reservoirs so that delayed absorption may occur. Even the vapour of some volatile agents can penetrate the intact skin and intoxication may follow. Wounds or abrasions (even minor injuries caused by shaving or by chemical depilation) present areas which are more permeable than intact skin.
- Chemical agents may contaminate food and drink and so be absorbed by the gastrointestinal tract. The penetration of agents by these various routes may not be accompanied by irritation or damage to the surfaces concerned.

CHARACTERISTICS OF NERVE AGENTS

Development

14. The nerve agents are a group of particularly toxic chemical warfare agents. They were developed just before and during World War II and are related chemically to the organophosphorus insecticides. The principle agents in this group are: GA (Tabun), GB (Sarin), GD (Soman), GF and VX, (in some countries the 'V' agents are known as 'A' agents).

Physical and Chemical Properties

15. Nerve agents are organophosphorus esters. The 'G' agents tend to be non-persistent whereas the 'V' agents are persistent. Some 'G' agents may be thickened with various substances in order to increase their persistence, and therefore the total amount penetrating intact skin. The physical properties are given in Table1.
16. It may be seen that at room temperature GB is a comparatively volatile liquid and therefore non-persistent. GD is also significantly volatile, as is GA though to a lesser extent. VX is a relatively non-volatile liquid and therefore persistent. It is regarded as presenting little vapour hazard to people exposed to it. In the pure state nerve agents are colourless and mobile liquids. In an impure state nerve agents may be encountered as yellowish to brown liquids. Some nerve agents have a faint fruity odour.
17. In general, nerve agents are moderately soluble in water with slow hydrolysis, highly soluble in lipids, rapidly inactivated by strong alkalis and chlorinating compounds.

Mechanism of Action

18. Nerve agents may be absorbed through any body surface. When dispersed as a spray or an aerosol, droplets can be absorbed through the skin, eyes and respiratory tract. When dispersed as a vapour at expected field concentrations,

the vapour is primarily absorbed through the respiratory tract. If enough agent is absorbed, local effects are followed by generalised systemic effects. The rapidity with which effects occur is directly related to the amount of agent absorbed in a given period of time.

Effects

19. The effects of the nerve agents are mainly due to their ability to inhibit acetyl cholinesterase throughout the body. Since the normal function of this enzyme is to hydrolyse acetylcholine wherever it is released, such inhibition results in the accumulation of excessive concentrations of acetylcholine at its various sites of action. These sites include the endings of the parasympathetic nerves to the smooth muscle of the iris, ciliary body, bronchial tree, gastrointestinal tract, bladder and blood vessels; to the salivary glands and secretory glands of the gastrointestinal tract and respiratory tract; and to the cardiac muscle and endings of sympathetic nerves to the sweat glands. The accumulation of acetylcholine at these sites results in characteristic muscarinic signs and symptoms.
20. The accumulation of acetylcholine at the endings of motor nerves to voluntary muscles and in some autonomic ganglia results in nicotinic signs and symptoms. The accumulation of excessive acetylcholine in the brain and spinal cord results in characteristic central nervous system symptoms.
21. The inhibition of cholinesterase enzymes throughout the body by nerve agents may be irreversible and its effects prolonged. Treatment with oximes should begin promptly. The role of oximes is to reactivate the enzymes.
22. Until the tissue cholinesterase enzymes are restored to normal activity, there is a period of increased susceptibility to the effects of another exposure to any nerve agent. The period of increased susceptibility occurs during the enzyme regeneration phase which could last from weeks to months, depending on the severity of the initial exposure. During this period the effects of repeated exposures are cumulative.

Location of Acetylcholinesterase

23. Acetylcholinesterase is found associated with the post-junctional membrane at the neuromuscular junction and in the cell bodies and processes of cholinergic neurons. The concentration is particularly high in some central nervous system neurons. The location of acetylcholinesterase in autonomic ganglia is less well understood than that at the neuromuscular junction. Acetylcholinesterase is also found at sites where, as yet, no functional role has been identified the musculotendinous junction, red blood cells, platelets and the placenta.

CHARACTERISTICS OF VESICANT AGENTS

24. Blister or vesicant agents are likely to be used both to produce casualties and to force opposing troops to wear full protective equipment thus degrading fighting efficiency, rather than to kill, although exposure to such agents can be

fatal. Blister agents can be thickened in order to contaminate terrain, ships, aircraft, vehicles or equipment with a persistent hazard. The vesicant agents include sulphur mustard (HD), nitrogen mustard (HN), the arsenical vesicants such as Lewisite (L) (this may well be used in a mixture with HD), and the halogenated oximes whose properties and effects are very different from those of the other vesicants. The physical properties of some vesicants are listed in Table 2.

25. Vesicants burn and blister the skin or any other part of the body they contact. They act on the eyes, mucous membranes, lungs, skin and blood-forming organs. They damage the respiratory tract when inhaled and cause vomiting and diarrhoea when ingested.

Mustard and Nitrogen Mustards

26. Protection against these agents can only be achieved by a full protective ensemble. The respirator alone protects against eye and lung damage and gives some protection against systemic effects. Extensive, slow healing skin lesions will place a heavy burden on the health services.
27. Sulphur mustard is the best known of these agents. Synthesised in 1854, its vesicant properties were discovered in the middle of the nineteenth century. As a chemical agent it was used for the first time in 1917 near Ypres from which it derives its French name (Yperite). Mustard is 2,2'-di(chloro-ethyl)-sulphide. It is also known by the name 'Lost' in German.
28. In the US the symbol HD has been given to the distilled product. In this chapter it will be indicated thus. In 1935 it was discovered that the vesicant properties remained when the sulphur atom was substituted by a nitrogen atom. Thus it became possible to synthesise the nitrogen mustards with similar properties, of which there are three. These are:
- N-ethyl-2,2'-di(chloroethyl)amine, or HN1;
 - N methyl-2,2'-di(chloroethyl)amine, or HN2; and
 - 2,2',2''tri(chloroethyl)amine, or HN3.
29. From a military standpoint, HN3 is the principal representative of the group of nitrogen mustards, and is the only nitrogen mustard likely to be used in war.

Mustards' Physico-Chemical Properties

30. The mustards are able to penetrate cell membranes in tissues and a great number of materials: woods, leather, rubber, plants etc. Due to their physical properties, mustards are very persistent in cold and temperate climates. It is possible to increase the persistency by dissolving them in non-volatile solvents, eg chlorinated rubber. In this way thickened mustards are obtained that are very difficult to remove by decontaminating processes. In warmer climates persistence of mustards is less, but higher concentrations of vapour occur.
31. When dissolved in water, mustards are hydrolysed at an appreciable rate, yielding poly-alcohols and hydrochloric acid, so that the solution may still be damaging to the skin. In more concentrated solutions, interaction of products becomes more pronounced and several dimers are formed. In 2 hours 22 per cent of the initial concentration is hydrolysed, in 6 hours 35 per cent and in 24 hours 60 per cent. However, as their solubility in water is very poor, two phases are generally formed, and hydrolysis of the undissolved bulk is very slow. In running water the contact surfaces are frequently changed and persistency is only a few days, but in stagnant water persistency can be several months. Mustard is denser than water, but small droplets remain on the water surface and present a special hazard in contaminated areas. Alkalinity and higher temperatures increase the rate of hydrolysis.
32. Owing to its bivalent sulphur atom, sulphur mustard has very good reducing properties. Depending on their strengths, oxidants oxidise mustard to a greater or lesser extent eg to sulfoxide, sulphone or sulphate. Of these only the sulphone has appreciable vesicant properties. Nitrogen mustards are much less easily oxidised than sulphur mustard.

Arsenical Vesicants

33. The arsines possessing the $-\text{AsCl}_2$ group are endowed with vesicant properties. Of these Lewisite is the best known and the most characteristic. Initially preparations contained considerable impurities, but at the end of World War I it was purified in the US, without having been used on the battlefield. Lewisite is 2-chlorovinyl-dichloroarsine, $\text{ClCH}=\text{CH}-\text{AsCl}_2$. The physico-chemical properties of **Lewisite** are as follows:
- **Physical Properties**—In a pure form Lewisite is a colourless and odourless liquid, but usually contains small amounts of impurities that give it a brownish colour and an odour resembling geranium oil. It is heavier than mustard, poorly soluble in water but soluble in organic solvents. The physical properties are shown in Table 2.
 - **Chemical Properties**—In contact with water Lewisite is hydrolysed at an appreciable rate, forming an oxide that is equally vesicant, according to the reaction: $\text{ClCH}=\text{CH}-\text{AsCl}_2 + \text{H}_2\text{O} + \text{ClCH}=\text{CH}-\text{AsO} + 2\text{HCl}$. In contact with strong alkalis. Lewisite is totally decomposed to non-vesicant products. Lewisite is very sensitive to oxidants due to the trivalent arsenic atom.

Halogenated Oximes

34. The urticant properties of the halogenated oximes were discovered long before World War II. To this group belong diiodoformoxime, dibromoformoxime, monochloroformoxime and dichloroformoxime. The last mentioned oxime is the most irritant of the series; it is commonly known as phosgene oxime, symbolised by CX. Its chemical formula is $\text{CCl}_2 = \text{NOH}$.

Physical and Chemical Properties.

35. Phosgene oxime is a white crystalline powder. It melts between 39–40°C, and boils at 129°C. By the addition of certain compounds it is possible to liquify phosgene oxime at room temperature. It is fairly soluble in water and in organic solvents. In aqueous solution phosgene oxime is hydrolysed fairly rapidly, especially in the presence of alkali. It has a high vapour pressure, its odour is very unpleasant and irritating. Even as a dry solid, phosgene oxime decomposes spontaneously and has to be stored at low temperatures.

CHARACTERISTICS OF LUNG–DAMAGING AGENTS (PULMONARY OEDEMAGENS)

36. Chemical agents which attack lung tissue, primarily causing pulmonary oedema, are classed as lung damaging agents. To this group belong phosgene (CG), diphosgene (DP), chlorine (CL) and chloropicrin (PS). Certain other substances, while, not likely to be used as agents, are still likely to be met with on in the field (eg nitrous fumes and zinc chloride smoke in an undeliquesced state) and may have a similar action. Similar substances encountered in fires eg PFIB and HCl may also induce lung damage.
37. The toxic action of phosgene is typical of a certain group of lung damaging agents. Phosgene is the most dangerous member of this group and the only one considered likely to be used in the future. Phosgene was used for the first time in 1915, and it accounted for 80 per cent of all chemical fatalities during World War I.

Physical and Chemical Properties

38. Phosgene is a colourless gas under ordinary conditions of temperature and pressure. Its boiling point is 8.2°C making it an extremely volatile and non-persistent agent. Its vapour density is 3.4 times that of air. It may therefore remain for long periods of time in trenches and other low lying areas. In low concentrations it has a smell resembling new mown hay. Phosgene is readily soluble in organic solvents and fatty oils. In water, phosgene is rapidly hydrolysed with the formation of hydrochloric acid and carbon dioxide. Further information is in Table 1.

Mechanism of Action

39. The mode of action is still not fully understood. It has been suggested that phosgene may act by inhibiting enzymes. It has more recently been suggested

that phosgene, which is itself a highly reactive molecule, may react directly and instantaneously at the alveolar and capillary wall, permitting plasma to flood the alveoli. Its effects usually reach a maximum 12–24 hours after exposure.

40. Whatever the mechanism of action, phosgene increases the permeability of the alveolar capillaries with resultant pulmonary oedema. This interferes with pulmonary gaseous exchange, leading to hypoxia. The loss of fluid into the alveoli also results in haemoconcentration which, together with hypoxia, causes cardiac embarrassment which may proceed to cardiac failure.

CHARACTERISTICS OF CYANOGEN AGENTS (BLOOD AGENTS)

41. Cyanogen agents produce their effects by interfering with oxygen utilisation at the cellular level. Inhalation is the usual route of entry. The term 'blood agents' has, in the past, been used to describe 'cyanogen agents'. It should be noted however, that not all 'blood agents' are cyanogens (eg carbon monoxide) and that cyanogens are not necessarily 'blood agents'.
42. In this chapter only hydrogen cyanide, [HCN, (AC)] and those agents that derive their toxicity primarily from the liberation of the CN-group in the organism will be discussed, but it should be noted that hydrogen sulphide, H₂S has a toxicity comparable with HCN and appears to act by a similar mechanism. Only HCN itself and the four cyanogen halides are likely to be of military interest. The cyanogen halides owe their toxicity to the CN-group, but the halogen moiety supplies them with their irritant properties. The most important of the cyanogen halides is cyanogen chloride (CK). During World War I hydrogen cyanide and cyanogen chloride were used and cyanogen bromide to a limited extent. The physical properties of hydrogen cyanide and cyanogen chloride are given in Table 6.

Hydrogen Cyanide

43. The physico-chemical properties for the Cyanogen agent are as follows:
- **Physical Properties**—Hydrogen cyanide is a colourless, highly volatile liquid and represents a non-persistent hazard. The vapour is less dense than air and has a faint odour, somewhat like bitter almonds, although about 25 per cent of people are unable to smell this. It is highly soluble and stable in water.
 - **Chemical Properties**—The CN compounds are readily oxidised by strong oxidants; eg potassium permanganate. Hydrogen cyanide has an affinity for oxygen and is flammable; hence it is less efficient when dispersed by artillery shells. Compounds which contain labile sulphur atoms (R-S=S²⁻) react with HCN even in vivo, for example: $\text{HCN} + \text{Na}_2\text{S}_2\text{O}_3 \rightarrow \text{HSCN} + \text{Na}_2\text{SO}_3$. Metal ions easily form complex compounds, for example: $\text{CoCl}_2 + 4\text{CN} \rightarrow \text{Co}(\text{CN})_4 + 2\text{Cl}$. Use is made of this property in some forms of therapy. Hydrogen cyanide, because of its volatility and low molecular weight, is poorly adsorbed by the charcoal in the canister of the respirator. This charcoal is therefore impregnated with metal salts in order to improve

the performance of the canister, but the protection provided against HCN is not unlimited.

- **Mechanism of Action**—The cyanide ion forms a reversible complex with the respiratory cytochrome oxidase enzyme system, an enzyme system essential for oxidative processes within cells. This results in impairment of cellular oxygen utilisation. The central nervous system, particularly the respiratory centre, is especially susceptible to this effect and respiratory failure is the usual cause of death.

Cyanogen Halides

44. Cyanogen chloride and cyanogen bromide, after absorption react in such a way that hydrogen cyanide is eventually released. Their effects on the body are essentially similar to those of hydrogen cyanide, but, in addition, they also have local irritant effects.

Physical and Chemical Properties

45. Cyanogen chloride is a colourless, highly volatile liquid. Although only slightly soluble in water, it dissolves readily in organic solvents. Its vapour, heavier than air, is very irritating to the eyes and mucus membranes. Cyanogen chlorides pungent, biting odour is marked by its irritating lachrymatory properties. Normally cyanogen chloride is non persistent.
46. Cyanogen halides are rather poorly adsorbed onto charcoal, especially if the charcoal is damp. The cyanide group, not being ionised, does not react well with the metal salts found in respirator charcoals.

Mechanism of Action

47. Cyanogen chloride acts in two ways. Its systemic effects are similar to those of hydrogen cyanide but it also has local irritant effects on the eyes, upper respiratory tract and lungs.

CHARACTERISTICS OF INCAPACITANTS

48. An incapacitant is a chemical agent which produces a temporary disabling condition that persists for hours to days after exposure to the agent has occurred (unlike that produced by riot control agents). Medical treatment while not essential may in some cases facilitate more rapid recovery. In the narrower sense the term has come to mean those agents that are:
 - highly potent (an extremely low dose is effective) and logistically feasible;
 - able to produce their effects by altering the higher regulatory activity of the central nervous system;
 - of a duration of action lasting hours or days, rather than of a momentary or fleeting action;

- not seriously dangerous to life except at doses many times the effective dose; and
 - not likely to produce permanent injury in concentrations which are military effective.
49. These criteria eliminate many drugs that might otherwise be considered as incapacitants. Opiates and strong sedatives are too dangerous on account of their low margin of safety and milder tranquillisers cause little actual loss of performance capability. Many compounds have been considered as incapacitants and health staff must be on the alert to detect and report any unusual clinical appearances. All lethal agents in low doses may produce incapacitating effects and it is possible that new agents for incapacitation may be developed. Agents which produce unconsciousness or induce vomiting may well be developed in the future.
50. In this chapter consideration will be given to two categories which are well known: CNS depressants (anticholinergics) and CNS stimulants (LSD). Although cannabinoids and psilocybin, for instance, have been considered in the past, their effective dose is too high for these to be regarded as likely agents for use in the field.

CNS Depressants

51. CNS depressants produce their effects by interfering with transmission of information across central synapses. An example of this type of agent is BZ, which blocks the muscarinic action of acetyl choline both peripherally and centrally. In the central nervous system anticholinergic compounds disrupt the high integrative functions of memory, problem solving, attention and comprehension. Relatively high doses produce toxic delirium which destroys the ability to perform any military task.

BZ (3-Quinuclidinyl Benzoate) and Similar Compounds

52. BZ and its analogues are glycollic acid esters. Some members of the group are liquid at ambient temperatures but BZ is a stable white crystalline powder that is only slightly soluble in water. These agents are metabolised primarily in the liver and excreted by the kidneys. Other characteristics are as follows:
- **Mechanism of Action**—BZ (3-Quinuclidinyl Benzoate) is a cholinergic blocking agent that at single doses of less than 1 mg produces delirium lasting several days. In this respect it resembles the well known belladonna alkaloids, atropine and scopolamine, except that it is more potent and its effects last longer. The safety margin (ratio of lethal to incapacitating dose) in humans is estimated to be at least 30. No permanent adverse effects have been reported from clinical studies.
 - **Pharmacology**—BZ is effective by all routes of administration, but its effectiveness percutaneously (when mixed with a suitable solvent) is limited, so that route is not likely to be used. However there are other related compounds which are effective percutaneously. It readily crosses

the blood-brain barrier and is distributed to all areas of the brain and spinal cord.

- **Effects**—After administration of an effective dose by inhalation, by mouth or by injection mild peripheral effects of BZ occur within one hour and maximal central effects occur after about four hours lasting 24 to 48 hours, with a peak at eight to ten hours. Some other compounds in this group may take longer for their effects to develop and to disappear. Doubling the dose prolongs the duration of severe central effects by about 40 hours and shortens the onset time of severe effects to about one hour.

53. BZ and other glycollates produce their effects within the nervous system in the same way as atropine and scopolamine, that is by interfering with cholinergic transmission at muscarinic sites, both in the peripheral autonomic nervous system and in the brain and spinal cord. Because of the wide distribution of these sites measurable effects upon almost every phase of neural regulation may be observed.

CNS Stimulants

54. CNS stimulants cause excessive nervous activity by facilitating transmission of impulses. The effect is to flood the cortex and other higher regulatory centres with too much information, making concentration difficult and causing indecisiveness and inability to act in a sustained purposeful manner. A well known drug which acts in this way is D-lysergic acid diethylamide; similar effects are sometimes produced by large doses of amphetamines.

LSD (D-Lysergic Acid Diethylamide)

55. LSD is solid at normal temperatures and is soluble in water. It is a very difficult agent to disseminate and consequently is likely to be used by an enemy only in a clandestine manner. Other characteristics are as follows:

- **Mechanism of Action**—Very small doses (for example 50 micrograms per person) are capable of inducing a psychotic state in humans, but the precise mechanism of action is not yet known. LSD has been shown to facilitate neural activity in the reticular activating system of the brain stem. It appears to interfere with the normal filtering action of this system, permitting sensory input to reach higher integrative centres without regard to its importance or relevance. The result is a decrease in the ability of the brain to process information selectively and in logical sequence.
- **Pathophysiology**—D-lysergic acid diethylamide is the most potent of the biologically active indole compounds, as little as 50 micrograms being required to produce dramatic psychological changes. Doses of 2 – 5 mg have been taken without permanent sequelae, and animal studies suggest that much higher doses may be tolerated. Convulsions may occur at doses above 2 mg. LSD may be inhaled or ingested. Initial effects appear within a few minutes of inhalation or within 30 to 60 minutes of ingestion. Maximum effects are reached within two to three hours and gradually subside over the next four to eight hours. The half-life in human plasma is

about three hours. Tolerance is acquired rapidly on repeated exposures at daily intervals, but is short lived. LSD appears to interact with endogenous neurotransmitters such as serotonin with which it shares the common feature of an indole nucleus. It is metabolised by the liver and excreted through the kidneys.

CHARACTERISTICS OF RIOT CONTROL AGENTS

56. Riot control agents are irritants characterised by a very low toxicity (chronic or acute) and a short duration of action. Little or no latent period occurs after exposure. Orthochlorobenzylidene malononitrile (CS) is the most commonly used irritant for riot control purposes. Chloracetophenone (CN) is also used in some countries for this purpose in spite of its higher toxicity. A newer agent is dibenzoxazepine (CR) with which there is little experience. Arsenical smokes (sternutators) have in the past been used on the battlefield. Apart from their lachrymatory action they also provoke other effects, eg bronchoconstriction and emesis and are some times referred to as vomiting agents. For historical reasons some older, more toxic compounds are briefly mentioned.

Lachrymators

57. The most common example and general characteristics of lachrymators are detailed below:
- **CS (Orthochlorobenzylidene Malononitrile)**—CS is used as a riot control agent in many countries. It is also commonly used as a training agent for simulation of chemical warfare conditions and for testing of respirators. The limit of perception by taste ranges from 0.25–0.5 mg.min.m³. The minimal irritant concentration ranges from 0.1–1.0 mg.min.m³, the IC_{t50} from 5–10 mg.min.m³ and the LC_{t50} for humans very much larger, estimated as 60 000 mg.min.m³. This provides a high margin of safety in its use.
 - **Properties**—CS is the code name for orthochlorobenzylidene malononitrile. On account of its stronger irritant effects and its lower toxicity it has superseded CN. It is a white crystalline solid substance. Solubility is very poor in water, moderate in alcohol and good in acetone, chloroform, methylene dichloride, ethylacetate and benzene. CS is unstable in aqueous solution. If enough CS can be dissolved in water (eg by adding propylene glycol or other organic co-solvent) spraying fluids with an irritant action of short duration result. Although the smoke is non-persistent, CS may stick to rough surfaces (eg clothes) from which it is released only slowly. At least one hour of aeration is necessary to cleanse such materials from CS after exposure. CS is usually dispersed as an aerosol generated pyrotechnically, or by spraying a solution of CS in a suitable solvent.
 - **Mechanism of Action**—Lachrymators act on the nerve endings, the cornea, mucous membranes and the skin. The reaction is very rapid. The toxicity of CS is very low, the estimated lethal concentration for humans

over one hour being 1000 mg.m^{-3} , whereas a concentration of 1 mg.m^{-3} is intolerable to most people.

- **Pathology**—Pathological examination of rabbits exposed to CS revealed an increase in number of goblet cells in the respiratory tract. Pulmonary oedema occurred after inhalation at very high concentrations, in excess of $20\,000 \text{ mg.min.m}^{-3}$. Experiments in dogs showed that the animals dying as a result of exposure to very high concentrations died from obstruction of the upper respiratory tract: inhalation of CS through an intratracheal cannula, on the other hand, caused pulmonary oedema.

CR (Dibenzoxazepine)

58. CR is a pale yellow crystalline solid which melts at 163°F (73°C) and is stable in organic solutions. It has limited solubility in water and is not hydrolysed in aqueous solutions. It has a pepper-like odour. The agent is currently used only in solution for dissemination in liquid dispensers. The solution in the dispensers contains 0.1 per cent CR in 80 parts propylene glycol and 20 parts water. In organic solutions, CR is an eye irritant at concentrations down to 0.0025 per cent or even lower. CR differs from CS in being less toxic when inhaled but CR skin effects are more pronounced. It is more persistent in the environment and on clothing. CR is similar in its effects to CS, but the minimum effective concentration is lower and the LCt_{50} is higher. Symptomatology and treatment are similar to those of CS.

CN (Chloracetophenone)

59. CN is a riot control agent and as a training agent is now superseded by CS, the latter being much less toxic. However, it is still in use by police in some countries.
60. **Properties**—CN is a clear yellowish brown solid, with a melting point of 54°C . It is poorly soluble in water, but dissolves in organic solvents. The white smoke smells like apple blossom. The minimal irritant concentration is 0.3 mg.m^{-3} . It has been estimated from experimental data that the LCt_{50} for humans is 7000 to $14000 \text{ mg.min.m}^{-3}$, but inhalation of 350 mg.m^{-3} for five minutes may be dangerous. The ICt_{50} is 20 to 40 mg.min.m^{-3} . CN is more toxic than CS.

CA and BA (CA (Bromobenzyl Cyanide) and BA (Bromoacetone))

61. Bromobenzyl cyanide (CA) and bromoacetone (BA) are older lachrymators. They are too toxic for use as riot control agents and must be considered obsolete. Their properties are listed in Table 5.

CHARACTERISTICS OF VOMITING AGENTS

62. Vomiting agents produce strong pepper-like irritation in the upper respiratory tract with irritation of the eyes and lachrymation. They cause violent uncontrollable sneezing, cough, nausea, vomiting and a general feeling of bodily discomfort. The principal agents in this group are diphenylchlorarsine

(DA), diphenylaminearsine chloride (Adamsite (DM)) and diphenylcyanoarsine (DC). DA, DM and DC are also classed as sternutators. They are dispersed as aerosols and produce their effects by inhalation or by direct action on the eyes. Their characteristics are as follows:

- **Properties**—They are non-persistent agents. The particles fall to the ground after dispersion and are virtually ineffective unless resuspended. Di-phenyl-cyanoarsine (DC) is the most irritating of the group. The principal characteristics of these agents are summarised in Table 6.
- **Colour and Odour**—It should be remembered that the colour of the solid agent depends on the degree of purity (technically raw products are often coloured) but the colour and odour of the smoke after dispersion may no longer be noticeable in concentrations which are nevertheless still highly irritant, so that odour and colour cannot be relied upon for detection.
- **Toxicity**—The following data are applicable to DM. The LC₅₀ estimated for humans is 13 000 to 44 000 mg.min.m⁻³ depending on the means of dissemination of the agent. The IC₅₀ for humans ranges from 22 to 150 mg.min.m⁻³. The maximum concentration which is stated to cause no permanent damage after inhalation for five minutes is 100 mg.m⁻³.
- **Mechanism of Action**—This consists of inhibition of the SH containing enzymes, especially those of the pyruvate dehydrogenase system. These enzymes play a part in the energy producing processes in the cell. The integrity of the cell structure depends on the proper functioning of the metabolic processes and inhibition of the enzyme mentioned interferes with cell respiration resulting in the destruction of cell structure.

PHYSIOLOGICAL EFFECTS OF NERVE AGENTS

Signs and Symptoms

63. The order in which signs and symptoms appear and their relative severity depend on the route of exposure and whether the casualty has been exposed to liquid agent or vapour. The signs, symptoms and their time course following exposure to nerve agents are given in Table 7 and Table 8. The local effects of vapour and liquid exposure are described followed by a description of the systemic effects which occur after significant absorption of agent via any route.

Effects of Nerve Agent Vapour

64. The lungs and the eyes absorb nerve agents rapidly. Changes occur in the smooth muscle of the eye, resulting in miosis and in the smooth muscle and secretory glands of the bronchi, producing bronchial constriction and excessive secretions in the upper and lower airways. In high vapour concentrations, the nerve agent is carried from the lungs throughout the circulatory system; widespread systemic effects may appear in less than 1 minute.

Local Ocular Effects

65. These effects begin within seconds or minutes after exposure, before there is any evidence of systemic absorption. The earliest ocular effect which follows minimal symptomatic exposure to vapour is miosis. This is an invariable sign of ocular exposure to enough vapour to produce symptoms. It is also the last ocular manifestation to disappear. The pupillary constriction may be different in each eye. Within a few minutes after the onset of exposure, there also occurs redness of the eyes due to conjunctival hyperaemia, and a sensation of pressure with heaviness in and behind the eyes. Usually vision is not grossly impaired, although there may be a slight dimness especially in the peripheral fields or when in dim or artificial light.
66. Exposure to a level of a nerve agent vapour slightly above the minimal symptomatic dose results in miosis, pain in and behind the eyes attributable to ciliary spasm, especially on focusing; some difficulty of accommodation and frontal headache. The pain becomes worse when the casualty tries to focus the eyes or looks at a bright light. Some twitching of the eyelids may occur. Occasionally there is nausea and vomiting which, in the absence of systemic absorption, may be due to a reflex initiated by the ocular effects. These local effects may result in moderate discomfort and some loss of efficiency but may not necessarily produce casualties.
67. Following minimal symptomatic exposure, the miosis lasts from 24 to 72 hours. After exposure to at least the minimal symptomatic dose, miosis is well established within half an hour. Miosis remains marked during the first day after exposure and then diminishes gradually over 2 to 3 days after moderate exposure, but may persist for as long as 14 days after severe exposure. The conjunctival erythema, eye pain, and headache may last from 2 to 15 days depending on the dose.

Local Respiratory Effects

68. Following minimal exposure, the earliest effects on the respiratory tract are a watery nasal discharge, nasal hyperaemia, sensation of tightness in the chest and occasionally prolonged wheezing expiration suggestive of bronchoconstriction or increased bronchial secretion. The rhinorrhoea usually lasts for several hours after minimal exposure and for about 1 day after more severe exposure. The respiratory symptoms are usually intermittent for several hours duration after mild exposure, and may last for one or two days after more severe exposure.

Effects of Liquid Nerve Agent

69. The effects of a liquid nerve agent are as follows:
- **Local Ocular Effects**—The local ocular effects are similar to the effects of nerve agent vapour. If the concentration of the liquid nerve agent contaminating the eye is high, the effects will be instantaneous and marked; and, if the exposure of the two eyes is unequal, the local manifestations may be unequal. Hyperaemia may occur but there is no immediate local inflammatory reaction such as may occur following ocular exposure to more irritating substances (for example, Lewisite).
 - **Local Skin Effects**—Following cutaneous exposure, there is localised sweating at and near the site of exposure and localised muscular twitching and fasciculation. However, these may not be noticed causing the skin absorption to go undetected until systemic symptoms begin.
 - **Local Gastrointestinal Effects**—Following the ingestion of substances containing a nerve agent, which is essentially tasteless, the initial symptoms include abdominal cramps, vomiting and diarrhoea.

Systemic Effects of Nerve Agent Poisoning

70. The sequence of symptoms varies with the route of exposure. While respiratory symptoms are generally the first to appear after inhalation of nerve agent vapour, gastrointestinal symptoms are usually the first after ingestion. Following comparable degrees of exposure, respiratory manifestations are most severe after inhalation, and gastrointestinal symptoms may be most severe after ingestion. Otherwise, the systemic manifestations are, in general, similar after any exposure to nerve agent poisoning by any route. If local ocular exposure has not occurred, the ocular manifestations (including miosis) initially may be absent. The signs, symptoms and their time course following exposure to nerve agent are given in Table 8.
71. The systemic effects may be considered to be nicotinic, muscarinic or by an action at receptors within the central nervous system. The predominance of muscarinic, nicotinic or central nervous system effects will influence the amount of atropine, oxime or anticonvulsant which must be given as therapy. These effects will be considered separately.

Muscarinic Effects of Nerve Agent Poisoning

- 72.** Tightness in the chest is an early local symptom of respiratory exposure. This symptom progressively increases as the nerve agent is absorbed into the systemic circulation, whatever the route of exposure. After moderate or severe exposure, excessive bronchial and upper airway secretions occur and may become very profuse, causing coughing, airway obstruction and respiratory distress. Audible wheezing may occur, with prolonged expiration and difficulty in moving air into and out of the lungs, due to the increased bronchial secretion or to bronchoconstriction, or both. Some pain may occur in the lower thorax and salivation increases.
- 73.** Bronchial secretion and salivation may be so profuse that watery secretions run out of the sides of the mouth. The secretions may be thick and tenacious. If postural drainage or suction is not employed, these secretions may add to the airway obstruction. Laryngeal spasm and collapse of the hypopharyngeal musculature may also obstruct the airway. The casualty may gasp for breath, froth at the mouth, and become cyanotic.
- 74.** If the upper airway becomes obstructed by secretions, laryngeal spasm or hypopharyngeal musculature collapse, or if the bronchial tree becomes obstructed by secretions or bronchoconstriction, little ventilation may occur despite respiratory movements. As hypoxaemia and cyanosis increase, the casualty will fall exhausted and become unconscious.
- 75.** Following inhalation of nerve agent vapour, the respiratory manifestations predominate over the other muscarinic effects; they are likely to be most severe in older casualties and in those with a history of respiratory disease, particularly bronchial asthma. However, if the exposure is not so overwhelming as to cause death within a few minutes, other muscarinic effects appear. These include sweating, anorexia, nausea and epigastric and substernal tightness with heartburn and eructation. If absorption of nerve agent has been great enough (whether due to a single large exposure or to repeated smaller exposures), there may follow abdominal cramps, increased peristalsis, vomiting, diarrhoea, tenesmus, increased lachrymation and urinary frequency. Cardiovascular effects are a bradycardia, hypotension and cardiac arrhythmias. The casualty perspires profusely, may have involuntary defecation and urination and may go into cardiorespiratory arrest followed by death.

Nicotinic Effects

- 76.** With the appearance of moderate muscarinic systemic effects, the casualty begins to have increased fatigability and mild generalised weakness which is increased by exertion. This is followed by involuntary muscular twitching, scattered muscular fasciculations and occasional muscle cramps. The skin may be pale due to vasoconstriction and blood pressure moderately elevated (transitory) together with a tachycardia, resulting from cholinergic stimulation of sympathetic ganglia and possibly from the release of epinephrine. If the exposure has been severe, the muscarinic cardiovascular symptoms will dominate and the fascicular twitching (which usually appear first in the eyelids

and in the facial and calf muscles) becomes generalised. Many rippling movements are seen under the skin and twitching movements appear in all parts of the body. This is followed by severe generalised muscular weakness, including the muscles of respiration. The respiratory movements become more laboured, shallow and rapid; then they become slow and finally intermittent. Later, respiratory muscle weakness may become profound and contribute to the respiratory depression. Central respiratory depression may be a major cause of respiratory failure.

Central Nervous System Effects

- 77.** In mild exposures, the systemic manifestations of nerve agent poisoning usually include tension, anxiety, jitteriness, restlessness, emotional lability, and giddiness. There may be insomnia or excessive dreaming, occasionally with nightmares. If the exposure is more marked, the following symptoms may be evident: headache, tremor, drowsiness, difficulty in concentration, impairment of memory with slow recall of recent events, and slowing of reactions. In some casualties there is apathy, withdrawal and depression. With the appearance of moderate symptoms, abnormalities of the electroencephalogram occur, characterised by irregularities in rhythm, variations in potential, and intermittent bursts of abnormally slow waves of elevated voltage similar to those seen in patients with epilepsy. These abnormal waves become more marked after one or more minutes of hyperventilation which, if prolonged, may occasionally precipitate a generalised convulsion.
- 78.** If absorption of nerve agent has been great enough, the casualty becomes confused and ataxic. The casualty may have changes in speech, consisting of slurring, difficulty in forming words, and multiple repetition of the last syllable. The casualty may then become comatose, reflexes may disappear and respiration may become Cheyne-Stokes in character. Finally, generalised convulsions may ensue. With the appearance of severe central nervous system symptoms, central respiratory depression will occur (adding to the respiratory embarrassment that may already be present) and may progress to respiratory arrest. However, after severe exposure the casualty may lose consciousness and convulse within a minute without other obvious symptoms. Death is usually due to respiratory arrest and anoxia, and requires prompt initiation of assisted ventilation to prevent death. Depression of the circulatory centres may also occur, resulting in a marked reduction in heart rate with a fall of blood pressure some time before death.

Cumulative Effects of Repeated Exposure

79. Daily exposure to concentrations of a nerve agent insufficient to produce symptoms following a single exposure may result in the onset of symptoms after several days. Continued daily exposure may be followed by increasingly severe effects. After symptoms subside, increased susceptibility may persist for up to three months. The degree of exposure required to produce recurrence of symptoms and the severity of these symptoms depend on the dose received and the time interval since the last exposure. Increased susceptibility is not limited to the particular nerve agent initially absorbed.

Chronic CNS Effects

80. In the absence of treatment, death is caused by anoxia resulting from airway obstruction, weakness of the muscles of respiration and central depression of respiration. When overwhelming doses of the agent are absorbed quickly, death occurs rapidly without orderly progression of symptoms.

PHYSIOLOGICAL EFFECTS OF VESICANT AGENTS

Mustard Effects

81. **Eyes**—In a single exposure the eyes are more susceptible to mustard than either the respiratory tract or the skin. Conjunctivitis follows exposure of about one hour to concentrations barely perceptible by odour. This exposure does not effect the respiratory tract significantly. A latent period of 4 – 12 hours follows mild exposure, after which there is lachrymation and a sensation of grit in the eyes. The conjunctivae and the lids become red and oedematous. Heavy exposure irritates the eyes after one to three hours and produces severe lesions. Although temporary blindness may occur, permanent blindness is very rare. Casualties should therefore be reassured and a positive attitude taken. Mustard burns of the eyes may be divided as follows:

- Mild conjunctivitis (75 per cent of cases in World War I). Recovery takes one to two weeks.
- Severe conjunctivitis with minimal corneal involvement (15 per cent of cases in World War I). Blepharospasm, oedema of the lids and conjunctivae occur, as may orange-peel roughening of the cornea. Recovery takes two to five weeks.
- Mild corneal involvement (10 per cent of cases in World War I). Areas of corneal erosion stain green with fluorescein dyes. Superficial corneal scarring and vascularisation occurs as does iritis. Temporary relapses occur and convalescence may take two to three months. Hospital care is indicated for casualties of this type.
- Severe corneal involvement (about 0.1 per cent of World War I mustard casualties). Ischaemic necrosis of the conjunctivae may be seen. Dense corneal opacification with deep ulceration and vascularisation occurs.

Convalescence may take several months and patients are predisposed to late relapses.

82. Skin—The hallmark of sulphur mustard exposure is the occurrence of a latent symptom and sign free period of some hours post exposure. The duration of this period and the severity of the lesions is dependent upon the mode of exposure, environmental temperature and probably on the individual. High temperature and wet skin are associated with more severe lesions and shorter latent periods. Some people are markedly more sensitive to mustard than others. Burns may be the result of either vapour or liquid exposure. The sequence of skin changes normally seen is as follows:

- *Erythema* (2–48 hour post-exposure)—This may be very striking and reminiscent of scarlet fever. Slight oedema of the skin may occur. Itching is common and may be intense. As the erythema fades areas of increased pigmentation are left (this sequence is reminiscent of that seen in sunburn).
- *Blistering*—Blisters are not, per se, painful, though they may be uncomfortable and feel tense. Blisters at points of flexure, anterior aspects of elbows and posterior aspects of knees, can seriously impede movement. Mustard blisters are delicate and may be easily ruptured by contact with bed linen, bandages or during transport of casualties. Crops of new blisters may appear as late as the second week post exposure. Blister fluid is not dangerous and does not produce secondary blistering if applied to skin.
- Deep burning leading to full thickness skin loss: this is particularly likely to occur on the penis and scrotum.
- Lesions tend to be painful and some patients complain of very severe pain. Healing of skin lesions is slow. The areas which were markedly erythematous darken and may become very hyperpigmented. Brownish-purple to black discolouration of some areas may occur. These changes tend to disappear over a period of several weeks with desquamation leading to the appearance of areas of hypopigmentation. The appearance of such areas alongside those of hyperpigmentation may be striking.
- The sensitivity of the skin depends on its thickness and upon the density of sweat and sebaceous glands. Apart from mucous membranes the most sensitive areas are the face, armpits, genitalia, neck, skin between the fingers and the nail beds. The palm of the hand, sole of the foot and the skin of the scalp are very resistant. If only a small dose is applied to the skin the effect is limited to erythema and after several days the colour changes from red to brown. The itch diminishes progressively and the epidermis desquamates. At higher doses blister formation starts, generally between 4 and 24 hours after contact, and this blistering can go on for several days before reaching its maximum. They are often more than 1 cm² and may be very large and pendulous. Their domes, which are thin and yellowish contain a relatively clear or slightly yellow liquid. The blisters are fragile and usually rupture spontaneously giving way to a suppurating and necrotic wound. The necrosis of the epidermal cells is extended to the

underlying tissues, especially to the dermis. The damaged tissues are covered with slough and are extremely susceptible to infection. The regeneration of these tissues is very slow, taking from several weeks to several months, much longer than the time required for the restoration of skin destroyed by physical means or by caustic compounds. Healing may result in contractures, scarring and fragile skin which may be easily damaged by trauma.

- 83. *Respiratory Tract***—Mustard attacks all the mucous membranes of the respiratory tract. After a latent period of four to six hours it irritates and congests the mucous membranes of the nasal cavity and the throat, as well as the epithelium of the trachea and large bronchi. Symptoms start with rhinorrhoea, burning pain in the throat and hoarseness of the voice. This pain may make the patient reluctant to cough. A dry cough gives way to copious expectoration. The vocal cords often become damaged, resulting in aphonia. Airway secretions and fragments of necrotic epithelium may obstruct the lungs; rales and reduced air entry can be detected by auscultation. There is pronounced dyspnoea. The damaged lower airways become infected easily, predisposing to bronchopneumonia after approximately 48 hours. If the inhaled dose has been sufficiently high the victim dies in a few days, either from pulmonary oedema or mechanical asphyxia due to fragments of necrotic tissue obstructing the trachea or bronchi, or from superimposed bacterial infection, facilitated by an impaired immune response.
- 84. *Bone Marrow***—Mustard agents may cause a general depletion of all elements of the bone marrow. The cells of the granulocyte series and megacaryocytes appear more susceptible to damage than those of the erythropoietic system. A reactive leucocytosis may occur during the first three days, followed by a decrease in the peripheral white cell count. The development of a severe leucopenia or an aplastic anaemia indicates a poor prognosis.
- 85. *Gastrointestinal Tract***—Ingestion of contaminated food or water may cause destruction of mucous membranes. Symptoms include nausea, vomiting, pain, diarrhoea and prostration. These features may make casualties reluctant to eat. Vomit and faeces may be bloodstained. Shock may occur.
- 86. *Systemic Action***—Systemically absorbed mustards by any route, including severe skin exposure, may cause signs similar to those of irradiation, such as headache, nausea, vomiting, leucopenia and anaemia. Gastrointestinal pain commonly occurs. Absorption of high doses may result in CNS excitation leading to convulsions, followed by CNS depression. Cardiac irregularities may occur with atrio-ventricular block and cardiac arrest may follow.

Lewisite Effects

- 87. *Eyes***—Liquid arsenical vesicants cause severe damage to the eye. On contact, pain and blepharospasm occur instantly. Oedema of the conjunctivae and lids follow rapidly and close the eye within an hour. Inflammation of the iris usually is evident by this time. After a few hours, the oedema of the lids begins to subside, while haziness of the cornea develops and iritis increases. The corneal injury, which varies with the severity of the exposure, may heal without residual

effects, induce pannus formation, or progress to massive necrosis. The iritis may subside without permanent impairment of vision, if the exposure was mild. After heavy exposure, hypopyon may ensue, terminating in necrosis, depigmentation of the iris and synechia formation. Liquid arsenical vesicants instantly produce a grey scarring of the cornea, like an acid burn, at the point of contact. Necrosis and sloughing of both bulbar and palpebral conjunctivae may follow very heavy exposure. All injured eyes are susceptible to secondary infection. Mild conjunctivitis due to arsenical vesicants heals in a few days without specific treatment. Severe exposure may cause permanent injury or blindness.

- 88. *Skin***—Liquid arsenical vesicants produce more severe lesions of the skin than liquid mustard. Contamination of the skin is followed shortly by erythema, then by vesication which tends to cover the entire area of erythema. The surrounding halo of erythema is less noticeable than with mustard blisters, although the two are often indistinguishable. Microscopically the blister roof is slightly thicker than the mustard blister roof, consisting of almost the complete thickness of the epidermis and showing more complete coagulation necrosis and less disintegrative necrosis than that of the mustard blister. The yellowish blister fluid is slightly more opaque than that of the mustard blister and microscopically, contains more inflammatory cells. It contains a trace of arsenic but is non-toxic and non-vesicant. There is deeper injury to the connective tissue and muscle, greater vascular damage, and more severe inflammatory reaction than is exhibited in mustard burns. In large, deep, arsenical vesicant burns, there may be considerable necrosis of tissue, gangrene and slough.
- 89. *Symptoms***—Stinging pain is felt usually in 10 to 20 seconds after contact with liquid arsenical vesicants. The pain increases in severity with penetration and in a few minutes becomes a deep, aching pain. Pain on contact with liquid arsenical vesicants usually gives sufficient warning so that decontamination may be begun promptly and deep burns thus avoided in conscious victims. After about five minutes of contact, there appears a grey area of dead epithelium resembling that seen in corrosive burns. Erythema is like that caused by mustard but is accompanied by more pain. Itching and irritation persist for only about 24 hours whether or not a blister develops. Blisters are often well developed in 12 hours and are painful at first, in contrast to the relatively painless mustard blister. After 48 to 72 hours, the pain lessens.
- 90. *Respiratory Tract***—The vapours of arsenical vesicants are so irritating to the respiratory tract that conscious casualties will immediately put on a mask to avoid the vapour. No severe respiratory injuries are likely to occur except among the wounded who cannot put on masks and the careless, who are caught without masks. The respiratory lesions are similar to those produced by mustard except that in the most severe cases, pulmonary oedema may be accompanied by pleural effusion.
- 91. *Systemic Effects***—Liquid arsenical vesicants on the skin, as well as inhaled vapour, are absorbed and may cause systemic poisoning. A manifestation of this is a change in capillary permeability, which permits loss of sufficient fluid from the bloodstream to cause haemoconcentration, shock and death. In non-fatal cases, haemolysis of erythrocytes has occurred with a resultant haemolytic

anaemia. The excretion of oxidised products into the bile by the liver produces focal necrosis of that organ, necrosis of the mucosa of the biliary passages with peribiliary haemorrhages and some injury of the intestinal mucosa. (Acute systemic poisoning from large skin burns causes pulmonary oedema, diarrhoea, restlessness, weakness, subnormal temperature and low blood pressure.

Phosgene Oxime Effects

92. Phosgene oxime also affects the eyes, causing corneal lesions and blindness and may affect the respiratory tract causing pulmonary oedema. The action on the skin is immediate: phosgene oxime provokes irritation resembling that caused by a stinging nettle. A few milligrams cause intense pain which radiates from the point of application, within a minute the affected area turns white and is surrounded by a zone of erythema which resembles a wagon wheel in appearance. In one hour the area becomes swollen and within 24 hours the lesion turns yellow and blisters appear. Some days later the area shows desquamation with necrosis of the skin followed by crust formation and a purulent discharge.

PHYSIOLOGICAL EFFECTS OF OEDEMAGENS

93. The outstanding feature of phosgene poisoning is massive pulmonary oedema. This is preceded by damage to the bronchiolar epithelium, development of patchy areas of emphysema, partial atelectasis, and oedema of the perivascular connective tissue. The trachea and bronchi are usually normal in appearance. This contrasts with the findings in chlorine and chloropicrin poisoning in which both structures may show serious damage to the epithelial lining with desquamation. The lungs are large, oedematous and darkly congested. Oedema fluid, usually frothy, pours from the bronchi and may be seen escaping from the mouth and nostrils. With exposure to very high concentrations death may occur within several hours; in most fatal cases pulmonary oedema reaches a maximum in 12 hours followed by death in 24–48 hours. If the casualty survives, resolution commences within 48 hours and, in the absence of complicating infection, there may be little or no residual damage.

Signs and Symptoms

94. During and immediately after exposure, there is likely to be coughing, choking, a feeling of tightness in the chest, nausea, and occasionally vomiting, headache and lachrymation. The presence or absence of these symptoms is of little value in immediate prognosis. Some patients with severe coughs fail to develop serious lung injury, while others with little sign of early respiratory tract irritation develop fatal pulmonary oedema. There may be an initial slowing of the pulse, followed by an increase in rate. A period follows during which abnormal chest signs are absent and the patient may be symptom-free. This interval commonly lasts 2 – 24 hours but may be shorter. It is terminated by the signs and symptoms of pulmonary oedema. These begin with cough (occasionally substernally painful), dyspnoea, rapid shallow breathing and

cyanosis. Nausea and vomiting may appear. As the oedema progresses, discomfort, apprehension and dyspnoea increase and frothy sputum develops. Rales and rhonchi are audible over the chest, and breath sounds are diminished. The patient may develop shock-like symptoms, with pale, clammy skin; low blood pressure and feeble, rapid heartbeat.

PHYSIOLOGICAL EFFECTS OF CYANOGENS

Cyanide Effects

95. **Signs and Symptoms**—The more rapidly the tissue cyanide levels build up, the more acute are the signs and symptoms of poisoning and the smaller is the total absorbed dose required to produce a given effect. In high concentrations there is an increase in the depth of respiration within a few seconds. This stimulation maybe so powerful that a casualty cannot voluntarily hold his breath. Violent convulsions occur after twenty to thirty seconds with cessation of respiration within one minute. Cardiac failure follows within a few minutes.
96. With lower concentrations the early symptoms are weakness of the legs, vertigo, nausea and headache. These may be followed by convulsions and coma, which may last for hours or days depending on the duration of exposure to the agent. If coma is prolonged recovery may disclose residual damage to the central nervous system manifested by irrationality, altered reflexes and unsteady gait which may last for several weeks or longer; temporary or permanent nerve deafness has also been described. In mild cases there may be headache, vertigo and nausea for several hours before complete recovery.

Cyanogen Chloride Effects

97. *Signs and Symptoms*—The signs and symptoms caused by cyanogen chloride are a combination of those produced by hydrogen cyanide and a lung irritant. Initially, cyanogen chloride stimulates the respiratory centre and then rapidly paralyses it. In high concentrations, however, its local irritant action may be so great that dyspnoea is produced. Exposure is followed by an immediate intense irritation of the nose, throat and eyes, with coughing, tightness in the chest and lachrymation. Afterwards the exposed person may become dizzy and increasingly dyspnoeic. Unconsciousness is followed by failing respiration and death within a few minutes. Convulsions, retching and involuntary defecation may occur. If these effects are not fatal, the signs and symptoms of pulmonary oedema may develop. There may be persistent cough with much frothy sputum, rales in the chest, severe dyspnoea and marked cyanosis.

PHYSIOLOGICAL EFFECTS OF INCAPACITANTS

BZ Effects

98. *Signs and Symptoms*—Small doses of BZ cause sleepiness and diminished alertness. Diagnosis can be made by noting increased heart rate, dry skin and lips, drowsiness and a progressive intoxication in the untreated individual as follows:

- From on to four hours—Tachycardia, dizziness, ataxia, vomiting, dry mouth, blurred vision, confusion, sedation progressing to stupor.
- From four to twelve hours—Inability to respond to the environment effectively or to move about.
- From 12–96 hours—Increasing activity, random unpredictable behaviour with delusions and hallucination; gradual return to normal 48 to 96 hours after exposure.

LSD

99. *Signs and Symptoms*—The clinical manifestations of LSD intoxication often include an early stage of nausea followed 45–60 minutes after dosage by a confused state in which delusions and hallucinations are common but not always experienced. There is some evidence that the effects may be held off, at least for a time, by determination to continue duty and that the presence of non-intoxicated comrades enables affected subjects to maintain contact with reality.

100. Subjects intoxicated with LSD show evidence of sympathetic stimulation (rapid heart rate, sweating palms, pupillary enlargement, cold extremities) and mental excitation (nervousness, trembling or spasms, anxiety, euphoria and inability to relax or sleep). Hyperthermia has been reported. Subjectively, feelings of tension, heightened awareness, exhilaration, kaleidoscopic imagery, emotions of every type, hilarity and exultation are characteristic. Paranoid ideas and more profound states of terror and ecstasy may also occur, especially in highly

suggestible individuals. True hallucinations are rare, as is homicidal or suicidal behaviour.

PHYSIOLOGICAL EFFECT OF RIOT CONTROL AGENTS

CS Effects

101. **Eyes**—Violent burning sensation, conjunctivitis (lasting up to 30 minutes), erythema of the eyelids (lasting about an hour) blepharospasm, violent lachrymation (over 10–15 minutes) and photophobia.
102. **Respiratory Tract**—The first symptom is a burning sensation in the throat, developing into pain and extending to the trachea and bronchi. At a later stage a sensation of suffocation may occur, often accompanied by fear. In addition a burning sensation in the nose, rhinorrhoea, erythema of the nasal mucous membranes and sometimes mild epistaxis occurs. The sense of taste is often distorted for some hours after exposure. Nausea, diarrhoea and headache have been observed. Sneezing occurs after mild exposure and may be persistent. Many exposed people have reported fatigue for some hours afterwards. Coughing, choking, retching and (rarely) vomiting occur after exposure.
103. **Skin**—A burning sensation occurs especially in moist areas, but soon disappears. This burning sensation may recur some hours later, often while washing the area. Prolonged exposure to large amounts (eg when handling CS in bulk) can cause erythema and vesicle formation. Prolonged exposure, continuous or intermittent, to high concentrations, combined with high temperatures and humidity in the field may result in a cumulative effect. Sensitivity to CS may be provoked. It has been shown that the particle size affects the clinical result. Small particles (1–5 μm) affect the eyes and respiratory tract more rapidly than larger ones (20–30 μm), but recovery after exposure to small particles is more rapid. Very large particles (50 μm) affect the eyes more than the respiratory tract, while recovery is slower.

CN Effects

104. Exposure to CN primarily affects the eyes, producing a burning sensation, lachrymation, inflammation and oedema of the eyelids, blepharospasm, and photophobia and, at high concentrations, temporary blindness. The severest of these symptoms is reached in a few minutes and then gradually decreases. After about one or two hours all symptoms disappear. High concentrations can cause irritation of the upper respiratory tract, inflammation of the skin with vesicle formation, visual impairment and pulmonary oedema. Drops or splashes in the eye may cause corrosive burns, corneal opacity and even permanent visual impairment. Drops or splashes on the skin may cause papulovesicular dermatitis and superficial skin burns. Ingestion of food or water contaminated with CN causes nausea, vomiting and diarrhoea.

PHYSIOLOGICAL EFFECTS OF VOMITING AGENTS

105. The onset of symptoms may be delayed for several minutes after initial exposure (especially with DM); effective exposure may, therefore, occur before the presence of the smoke is suspected. If the mask is put on then, symptoms will increase for several minutes despite adequate protection. As a consequence, the casualties may believe their mask is ineffective and by removing it expose themselves further.

106. Inhalation is followed by a burning sensation in the nose and throat, hypersalivation, rhinorrhea, coughing, sneezing, nausea and vomiting. Mental depression may occur during the progression of symptoms. The paranasal sinuses are irritated and fill with secretions and severe frontal headache results. Prolonged exposure may cause retrosternal pain, dyspnoea and asthma like symptoms. Symptoms reach their climax after 5–10 minutes and disappear one to two hours after cessation of exposure. Effects on the eyes are slight and are restricted to a burning sensation and lachrymation. Exposure of the skin to high concentrations will cause erythema and itching, proceeding to a burning sensation and vesicle formation. On the battlefield high concentrations are not likely to occur so that affection of the eyes and skin is unlikely. Ingestion of food and water contaminated by sternutators may cause nausea, vomiting, diarrhoea (sometimes bloodstained) and weakness and dizziness have been reported.

107. High concentrations are not expected in the open owing to movement of air, but may be met within enclosed spaces (shelters, tents etc), and under these circumstances the skin may show vesicle formation, capillary damage and localised swelling, while corneal necrosis and pulmonary oedema are possible results. Unsteady gait and a positive Romberg sign have been reported. Other neurological results of severe exposure include hyperaesthesia, anaesthesia and paraesthesia, especially in the legs. Loss of consciousness has been reported.

Table 1: Physical Properties of Nerve Agents

Table 2: Physical Properties of Vesicants

	PHOSGENE (CG)	DIPHOSGENE (DP)
Appearance	Colourless gas	Colourless gas
Chemical Formula	COCl_2	ClCOOCCl_3
Molecular Weight	98.9	197.9
Density (g.cm^{-3})	1.38 (20°C)	1.65 (20°C)
Melting Point (°C)	-128	-57
Boiling Point (°C)	7.6	127
Vapour Density	3.4	6.8
Vapour Pressure (mmHg)	365 (-10°C) 555 (0°C) 1173 (20°C)	1 (0°C) 4.2 (20°C)

Volatility (mg.m-3)	528000 (-40°C)	12000 (0°C)
	2200 000 (-10°C)	45000 (20°C)
	4300000 (7.6°C)	270000 (52°C)

Table 3: Physical Properties of Lung-Damaging Agents

	HYDROGEN CYANIDE (AC)	CYANOGEN CHLORIDE (CK)
Appearance	Colourless liquid giving off a colourless vapour	Strongly irritating colourless gas
Chemical Formula	HCN	CNCl
Molecular Weight	27.02	61.48
Density (g.cm-3)	0.687 (10°C)	1.18 (20°C)
Melting Point (°C)	-13.3	-6.9
Boiling Point (°C)	25.7	12.8
Vapour Density	0.93	2.1
Vapour Pressure (mmHg) at		
-10°C	165	1010
0°C	256	
20°C	600	
25°C	742	
Volatility at		
-40°C (mg.m-3)	37 000	6 132 000
25°C	1 080 000	

Table 4: Physical Properties of Cyanogen Blood Agents

Property	CA	BA
Appearance	Yellow, solid	Colourless liquid
Melting point	25°C	-54°C
Boiling point	227 - 242°C	136°C
Specific gravity	1.52	1.63
Solubility in water	Poor	Poor
Solubility in organic solvents	Good	Good
Volatility at 20°C	130 mg.m-3	75000 mg.m-3
Smoke Vapour Odour Colour	Rotting Fruit White	Stinging Colourless
Minimal Irritant Concentration	0.3 mg.m-3	1.0 mg.m-3

Table 5: Properties of CA and BA

Property	DM	DA	DC
Appearance	Yellow or Green Solid	Colourless, crystalline	Colourless solid
Melting point	195°C	38°C	38°C
Boiling point	410°C	330°C	346 - 337°C
Specific gravity	1.68	1.4	
Solubility in water	Poor	Poor.	Poor.
Solubility in organic solvents	Poor	Good.	Good.
Volatility at 20°C	0.02	0.68	1.5
Smoke Vapour Odour Colour	Coal fire Yellow	Shoe polish White or Grey	Garlic White
Minimal Irritant Concentration	0.1 mg.m-3	0.1 mg.m-3	0.25 mg.m-3

Table 6: Properties of Vomiting Agents

Short term Ct mg.min.m ⁻³	Approximate AChE Depression	Symptoms and Signs	
		Vapour	Systemic Exposure only Eyes Protected
<2	<5%	Incipient miosis (miosis produced at Ct=2, t=30 min) slight headache.	Nil
5	20%±10%	Increased miosis, headache, eye pain, rhinorrhoea, conjunctival injection, tightness in chest.	? Tightness in chest
5-15	20-50% ±10%	Eye signs maximal. Bronchospasm in some subjects.	Symptoms beginning to appear. Bronchospasm
15	50%±10%	Bronchospasm and all the effects already described.	Wheezing, salivation, eye effects, nausea, vomiting. (Local sweating and fasciculation in liquid contamination of the skin)
40	80%±10%	Symptoms and signs as for systemic exposure	Weakness, defecation, urination, paralysis, convulsions.
100	100%	Respiratory Failure DEATH	 DEATH

Table 7: Likely Signs and Symptoms of GB Poisoning shown in terms of Vapour Exposure and approximate Blood Acetyl Cholinesterase Depression

All symptoms and signs will be subject to very considerable inter-subject variation.

	SITE OF ACTION	EFFECTS
1.	<p>Muscarinic</p> <p>Pupils</p> <p>Ciliary body</p> <p>Nasal mucous membranes</p> <p>Bronchial tree</p> <p>Gastrointestinal</p> <p>Bronchial tree</p> <p>Gastrointestinal</p> <p>Sweat glands</p> <p>Salivary glands</p> <p>Lachrymal glands</p> <p>Heart</p> <p>Pupils</p> <p>Ciliary body</p> <p>Bladder</p>	<p>Miosis, marked, usually maximal (pin-point), sometimes unequal.</p> <p>Frontal headache, eye pain on focusing, blurring of vision.</p> <p>Rhinorrhoea, hyperaemia.</p> <p>Tightness in chest, bronchoconstriction, increased secretion, cough.</p> <p>Occasional nausea and vomiting.</p> <p>Following Systemic Absorption (depending on dose)</p> <p>Tightness in chest, with prolonged wheezing expiration suggestive of bronchoconstriction or increased secretion, dyspnoea, pain in chest, increased bronchial secretion, cough, cyanosis, and pulmonary oedema.</p> <p>Anorexia, nausea, vomiting, abdominal cramps, epigastric and substernal tightness (cardiospasm) with 'heartburn' and eructation, diarrhoea, tenesmus, involuntary defecation.</p> <p>Increased sweating.</p> <p>Increased salivation.</p> <p>Increased lachrymation.</p> <p>Bradycardia.</p> <p>Miosis, occasionally unequal, later maximal miosis (pin-point).</p>
2.	<p>Nicotinic</p> <p>Striated muscle</p> <p>Sympathetic</p>	<p>Blurring of vision, headache.</p> <p>Frequency, involuntary micturition.</p> <p>Easy fatigue, mild weakness, muscular twitching, fasciculations, cramps, generalised weakness/flaccid paralysis (including muscles of respiration) with dyspnoea and cyanosis.</p> <p>Pallor, transitory elevation of blood pressure followed by hypotension.</p>
3.	<p>Central Nervous System</p>	<p>Immediate (Acute) Effects: Generalised weakness, depression of respiratory and circulatory centres with dyspnoea, cyanosis and hypotension; convulsions, loss</p>

		of consciousness and coma.
		Delayed (Chronic) Effects: Giddiness, tension, anxiety, jitteriness, restlessness, emotional lability, excessive dreaming, insomnia, nightmares, headaches, tremor, withdrawal and depression, bursts of slow waves of elevated voltage in EEG (especially on hyperventilation), drowsiness, difficulty concentrating, slowness of recall, confusion, slurred speech, ataxia.

Note

- (a) Refer to Chapter 5.45 to refresh on ASBESTOS

Table 8: Signs and Symptoms of Nerve Agent Poisoning

CHAPTER 23

MEDICAL MANAGEMENT OF CHEMICAL INCIDENTS

NERVE AGENT INCIDENT EFFECTS

Diagnosis

1. Nerve agent poisoning may be identified from the characteristic signs and symptoms. If exposure to vapour has occurred, the pupils will be very small, usually pin-pointed. If exposure has been cutaneous, or has followed ingestion of a nerve agent in contaminated food or water, the pupils may be normal or, in the presence of severe systemic symptoms, slightly to moderately reduced in size. In this event, the other manifestations of nerve agent poisoning must be relied on to establish the diagnosis. No other known chemical agent produces muscular twitching and fasciculations, rapidly developing pin-point pupils, or the characteristic train of muscarinic, nicotinic and central nervous system manifestations.
2. It is important that individual service members know the following **mild** and **severe** signs and symptoms of nerve agent poisoning. Service members who have most or all of the symptoms listed below must **immediately** receive first aid (self-aid or buddy aid respectively).

'Mild' Poisoning (self-aid)

3. Casualties of **mild** poisoning may experience most or all symptoms of:
 - unexplained runny nose;
 - unexplained sudden headache;
 - sudden drooling;
 - difficulty in seeing (dimness of vision and miosis);
 - tightness in the chest or difficulty in breathing;
 - localised sweating and muscular twitching in the area of the contaminated skin;
 - stomach cramps;
 - nausea; and/or
 - bradycardia or tachycardia.

'Moderate' Poisoning

4. Casualties with **moderate** poisoning will experience an increase in the severity of most or all of the **mild** symptoms. Especially prominent will be an increase in

fatigue, weakness and muscle fasciculations. The progress of symptoms from mild to moderate indicates either inadequate treatment or continuing exposure to agent.

'Severe' Symptoms (Buddy Aid)

5. Casualties with **severe** poisoning will experience most or all of the **mild** symptoms, plus most or all symptoms of:
 - strange or confused behaviour;
 - wheezing, dyspnoea (severe difficulty in breathing) and coughing;
 - severely pin-pointed pupils;
 - red eyes with tearing;
 - vomiting;
 - severe muscular twitching and general weakness;
 - involuntary urination and defecation;
 - convulsions;
 - unconsciousness;
 - respiratory failure; or
 - bradycardia.
6. Casualties with severe symptoms will not be able to treat themselves and must receive prompt buddy aid and follow-on medical treatment if they are to survive.

Treatment

7. The lethal effects of nerve agent poisoning may be combated by a combination of pre-treatment and post exposure therapy. (See Annex A.)

Pre-treatment

8. Poisoning by nerve agents which form rapidly aging complexes (for example Soman) may be particularly difficult to treat. These difficulties have been solved, in part, by the use of carbamates as pre-treatment. The terms pre-treatment or prophylaxis should perhaps be defined as used in this context:
 - **Pre-treatment**—The administration of drugs in advance of poisoning designed to increase the efficacy of treatment administered post-poisoning.
 - **Prophylaxis**—The administration of drugs in advance of the poisoning designed to make post-poisoning therapy unnecessary.

9. The terms are to an extent interchangeable and as, in cases of severe poisoning, post-poisoning therapy is nearly always needed the term pre-treatment will be used here.
10. Carbamate anticholinesterases (eg pyridostigmine) may be used as pre-treatments against nerve agent poisoning by virtue of their capacity to bind acetylcholinesterase **reversibly**, preventing the organophosphate binding to the enzyme. The term reversible is used comparatively: the carbamate-acetylcholinesterase complex breaks down fairly rapidly, while organophosphate-acetylcholinesterase complexes break down very slowly. The aged soman-acetylcholinesterase complex does not break down.
11. When carbamates are used as pre-treatments carbamoylation of acetylcholinesterase prevents phosphorylation but later the carbamate-acetylcholinesterase complex dissociates freeing active enzyme. Current pre-treatment regimes bind 30–40 per cent of available red blood cell acetyl cholinesterase thereby allowing the carbamate to protect some of the AChE against attack by nerve agent.
12. The carbamate pyridostigmine, given in a dose of 30 mg every eight hours, is used as a pre-treatment. In conjunction with post-exposure therapy, good protection against lethality is obtained within two and a half hours of the first dose, but is not optimal until the third dose. Good compliance is required if optimal protection is to be obtained. The importance of pyridostigmine pre-treatment should therefore be stressed during training. Pyridostigmine pre-treatment should be stopped upon developing symptoms of nerve agent poisoning following a chemical warfare attack and post-exposure therapy started.
13. Pyridostigmine tablets were taken over a prolonged period by large numbers of troops during the Gulf War of 1991. The effects of pyridostigmine were examined in several studies including one uncontrolled study of 42 000 troops when, following the recommended dose regime, under the stress of combat conditions, gastrointestinal changes including increased flatus, loose stools, abdominal cramps and nausea were noted by approximately half the population. Other reported effects were urinary urgency, headache, rhinorrhoea, diaphoresis and tingling of the extremities. These effects were considered tolerable. They did not noticeably interfere with performance of the full range of demanding physical and mental tasks required of service personnel.
14. Symptoms due to pyridostigmine may be ameliorated by taking the tablets with food. Pyridostigmine pre-treatment was discontinued on medical advice in less than 0.1 per cent of individuals, generally because of intolerable nausea and diarrhoea. When taken in excess of the recommended dosage, symptoms of carbamate poisoning will occur. These include diarrhoea, gastrointestinal cramps, tight chest, nausea, rhinorrhoea, headache and miosis.

Post-exposure Therapy

15. The main principles of therapy for nerve agent poisoning are early treatment, assisted ventilation, bronchial suction, muscarinic cholinergic blockade (atropine), enzyme reactivation (oximes) and anticonvulsants (benzodiazepines). Medical treatment guidelines are enclosed at Annex A.

Emergency Field Therapy

16. **Self-Aid (or Buddy Aid)**—This can be achieved as follows:
- This comprises first aid measures which personnel can apply to help themselves. The rapid action of nerve agents calls for immediate self-treatment. Unexplained nasal secretion, salivation, tightness of the chest, shortness of breath, constriction of pupils, muscular twitching, or nausea and abdominal cramps call for the immediate intramuscular injection of 2 mg of atropine, combined if possible with oxime. From one to three automatic injection devices, each containing 2 mg atropine or mixture of atropine, oxime and/or anticonvulsant, are carried by each person.
 - One device should be administered immediately the symptoms and/or signs of nerve agent poisoning appear. This may be done by the casualty or by a buddy; the injection being given perpendicularly through the clothing into the lateral aspect of the middle of the thigh. Further devices, up to a total of three, should be administered by the casualty or by their buddy during the following 30 minutes if the symptoms and/or signs of poisoning fail to resolve.
 - The timing of these further injections and whether they are given at one time or separately may depend on the casualty's condition and on instructions promulgated by individual organisations.

Note

Note: If automatic injectors are used in the absence of exposure to agent, the following signs and symptoms may be seen: Dry mouth, dry skin, fast pulse (>90 beats per minute), dilated pupils, retention of urine and central nervous system disturbance. Susceptibility to heat exhaustion or heat stroke is increased, particularly in closed spaces or while wearing protective clothing.

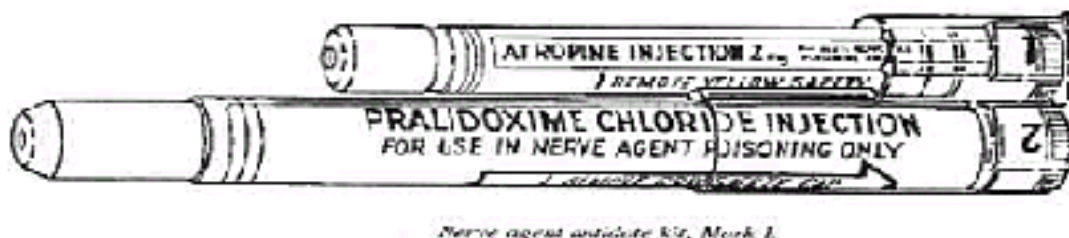

Figure 1: Nerve Agent Antidote Kit—Mark 1

- 17. First Aid by Trained Personnel**—This comprises the emergency actions undertaken to restore or maintain vital bodily functions in a casualty. Wherever the casualty is not masked the respirator must be adjusted for them by the nearest available person. Attention should be given to decontamination at the earliest possible moment and any skin contamination must be removed with a personal decontamination kit. The following points should be taken into account:
- After nerve agent poisoning, the administration of atropine is repeated at intervals until signs of atropinization (dry mouth and skin and tachycardia >90 per minute) are achieved. Miosis from vapour exposure is not relieved by systemic atropine.
 - Mild atropinization should be maintained for at least 24 hours by intramuscular injection of 1–2 mg of atropine at intervals of 1/2 to 4 hours, as required. The danger of ventricular arrhythmias arising from atropinization while the casualty is anoxic must be remembered.
 - Assisted ventilation is required for severely poisoned individuals as they will have:
 - Marked bronchoconstriction
 - Copious secretions in the trachea and bronchi
 - Paralysis of the respiratory muscles and
 - Central respiratory depression, hypoxia and convulsions.
- 18.** Positive pressure resuscitation should be given but the pressure necessary to overcome the bronchoconstriction may be more than 65 cm of water so that intubation if possible is highly desirable. In an uncontaminated atmosphere assisted ventilation may be done by the standard mouth to mouth method after decontamination of the casualty's face and mouth. In a contaminated atmosphere ventilation may be given by a portable resuscitator with NBC filter attached. Both the casualty and the resuscitator should be decontaminated. In a well equipped medical facility, mechanical resuscitation of the positive pressure type may be used with endotracheal intubation or tracheostomy - artificial respiration must be continued until the casualty is breathing normally or the medical personnel have pronounced the casualty dead. Due to the production of copious secretions, regular suction will be required.

Pharmacological Treatment of Nerve Agent Poisoning

- 19.** The pharmacological treatment of nerve agent poisoning involves the use of:
- anticholinergics to antagonise the muscarinic effects (atropine).
 - oximes to reactivate inhibited enzyme.
 - anticonvulsants to prevent CNS damage.

Atropine Treatment

20. Atropine sulphate remains an essential drug in the treatment of nerve agent poisoning. It acts by blocking the effects of acetylcholine at muscarinic receptors and so produces relief from many of the symptoms previously listed. If given in large doses, some therapeutic effects are also produced within the central nervous system although atropine does not readily penetrate the blood brain barrier and central muscarinic receptors are thought not to be identical with those in the periphery. It is thought to counteract the respiratory depression in the medulla oblongata.
21. Urgent treatment with atropine in cases of nerve agent poisoning is essential. After the emergency field treatment atropinisation should be maintained for at least twenty four hours by intramuscular injection or slow intravenous infusion of 1 to 2 mg of atropine per hour as required. The dose should be repeated at intervals until signs of successful atropinisation are noted. Intervals of five to 15 minutes seem reasonable, but severe poisoning may require higher doses (4 mg to 6 mg per hour or more). Signs of successful atropinisation include the drying up of bronchial, salivary and skin secretions and an increase in heart rate to greater than 90 beats per minute.
22. The effect of atropine in drying bronchial secretions may make the removal of mucus more difficult so suction is likely to be necessary. In excessive doses, atropine may render the ischaemic myocardium more liable to arrhythmias and ECG monitoring should be undertaken in all patients if possible.
23. Atropine overdosage may produce euphoria, hallucinations, anxiety and delirium and close observation of patients is necessary. Bladder dysfunction may necessitate catheterisation.
24. By inhibition of sweat production, atropine increases heat stress and in warm or hot weather care must be taken to avoid hyperthermia.
25. Atropine given parenterally has comparatively little effect on nerve agent induced miosis. The local application of cycloplegics (atropine eye drops) to the eye reduces both the degree of miosis, eye pain and headache. However, expert opinion on the value of atropine containing eye drops in the management of nerve agent induced miosis remains divided. It is believed by some that problems of accommodation may be made worse by the application of the drops and that, overall, little benefit may be produced.
26. If atropine is administered in the absence of nerve agent poisoning, the following effects may be noted: dryness of the mouth and pharynx, decreased sweating, slight flushing and tachycardia, some hesitancy of micturition, slightly dilated pupils, mild drowsiness, slowness of memory and recall and blurring of near vision. After 2 mg these symptoms should not interfere with ordinary activity except in the occasional person, in hot environments or at high work rates. Higher doses, or repeated doses, will produce more marked symptoms which will usually not be totally incapacitating except in warm environments or high work rates. The effects of atropine are fairly prolonged, lasting three to five

hours after one or two injections of 2 mg and 12 to 24 hours after marked over-atropinisation.

Oxime Treatment

27. Whilst atropine blocks the muscarinic effects of nerve agent poisoning it has little effect upon the nicotinic actions of the agent at the skeletal neuromuscular junction and at the autonomic ganglia. Amelioration of the effects of nerve agents at these sites and also at muscarinic sites can however be obtained by reactivation of the inhibited acetylcholinesterase by means of oximes. Oximes therefore, relieve the clinically important symptom of skeletal neuromuscular blockade. However, they penetrate into the central nervous system poorly, and the simultaneous administration of atropine is therefore still required. **Atropine is required as oxime treatment is neither rapid nor 100 per cent effective due to a variety of factors.**

Enzyme Reactivation Treatment

28. The relative potency of different oximes in reactivating acetylcholinesterase inhibited by some nerve agents is given in Table 1. Dosing schemes for the clinical intravenous use of currently available oximes, as applied in poisoning of humans by organophosphate insecticides, are shown in Table 2. Under field conditions similar doses can be given intramuscularly, but care should be taken to avoid accidental intra-arterial injection. The dose rates given could form the base for the determination of national dosing procedures which should include emergency field treatment.
29. An alternative method of administering oxime is as a continuous infusion. On the basis of a theoretical therapeutic plasma concentrations, the loading dose and maintenance dose for intravenous use can be calculated for different oximes using data obtained in healthy human volunteers (Table 3). Data from human organophosphorus insecticide poisoning suggest that these dose rates are also applicable in patients.
30. Clinical experience in human poisoning by organophosphorus insecticide shows that oxime treatment should be continued for some hours after reactivation has been obtained and the patient has recovered. If no enzyme reactivation, or other non-reactivation effects, has been obtained after a twenty four to forty eight hour period of treatment and the patient has not recovered, then it should be accepted that the enzyme inhibition is resistant to treatment by the particular oxime and administration should be stopped. There is only limited experience with human poisoning with organophosphorus nerve agents, but animal data suggest that the clinically relevant persistence of nerve agent in the body will probably be shorter than for insecticides. It may be suggested therefore, that oxime treatment should be continued until the recovery of the patient, with a probable maximum duration of twenty four to forty eight hours.

Oxime-Induced Side Effects

31. The rapid injection of pralidoxime (PAM Cl or P2S) can produce drowsiness, headache, disturbance of vision, nausea, dizziness, tachycardia and an increase in blood pressure, hyperventilation and muscular weakness. Obidoxime produces hypotension, a menthol-like sensation and a warm feeling in the face. On intramuscular injection it can produce a dull pain at the site of injection; after multiple dosing, hepatic dysfunction can be observed. HI6 may produce similar effects but generally has fewer side-effects.

Anticonvulsant Treatment

32. Atropine protects only partially against convulsions and the resulting brain damage in severe poisoning. Complementary treatment, including anticonvulsants, should be applied as necessary. It has been shown in experimental soman poisoning that diazepam antagonises the convulsive action of soman and that addition of diazepam to the basic treatment regime greatly improves morbidity and mortality, independent of its anticonvulsive effect. Diazepam is the drug of choice and should be injected intramuscularly as a 10 mg dose initially and further doses should be given frequently enough to control convulsions. This may require injections at intervals ranging from a few minutes to several hours. **In an ideal environment diazepam IMI should be avoided (ie give IVI) as absorption is erratic and it may produce sterile abscesses.**
33. **Correction of acidosis is also important, especially in facilitating the action of oximes.**

Supportive Care

34. Although pre and post exposure therapy will protect against lethality casualties may still be incapacitated. A patient severely poisoned by an anticholinesterase is a critical medical emergency and may require intensive care for days or weeks. Assisted ventilation may be needed for many hours or days and the patient may be comatose for hours or days and brain damage may result from periods of hypoxia. General supportive care such as IV feeding, restoring electrolyte balance, treatment of shock and control of convulsions is needed. Therapy to control infection, should this occur, should be on the usual lines. Special care should be taken using muscle relaxants in patients poisoned by nerve agents.

VESICANTS INCIDENT—MUSTARD EFFECTS

Therapy

35. There is no specific treatment available for the treatment of mustard lesions. Medical treatment guidelines are enclosed at Annex B. The aim of therapy is to:
 - relieve symptoms;

- prevent infections; and
- promote healing.

Eye Lesions

- 36.** The effects of mustard on the eyes are very painful. Local analgesics may increase corneal damage and are not recommended. Systemic analgesics (narcotics) should therefore be used as required. Secondary infection is a serious complication and increases the amount of corneal scarring. To prevent infection treat with appropriate anti-bacterial preparations. When the lesion proves more serious (blistering of the eyelids, blepharospasm etc) continue application of the anti-bacterial preparation at more frequent intervals. Patients with corneal lesion should receive mydriatics to prevent adhesions between the iris and cornea. In case of troublesome secretions accumulating, the eyes may be carefully irrigated with a 0.9 per cent sterile saline solution and sterile petroleum jelly (Vaseline) may be applied to the eyelids to prevent sticking. Do not cover the eyes with a bandage, but, if necessary, protect them with dark or opaque goggles. When the eyelids can be separated without too much pain examine the cornea for possible lesions with fluorescein solution followed by lavage: a green spot indicates a lesion, which, when severe should be treated by an ophthalmologist as soon as possible. In some countries ophthalmologists have recommended controversial treatments including the use of citrate and ascorbate eye drops and regular topical steroids.
- 37.** More severe injuries will cause enough oedema of the lids, photophobia and blepharospasm to obstruct vision. This alarms the patients. To allay their fears, the lids may be gently forced open to assure them that they are not blind. Although temporary blindness may occur, permanent blindness is very rare. Casualties should therefore be reassured and a positive attitude taken.

Skin Lesions

- 38.** It is important to ensure that no remaining contamination is present before commencing treatment. The skin turns red and itches intensely. This itching can be diminished by local applications of cooling preparations eg calamine lotion, corticosteroids in solution or even water. Ointments and creams are not advised for microbiological reasons. Severe erythema around the genitalia may become quite painful and associated weeping and maceration may ensue. Often, treatment with exposure of the area is desirable and care must be taken so that secondary infection of tissue does not occur.
- 39.** Infection is the most important complicating factor in the healing of mustard burns. There is no consensus on the need to de-roof blisters or on the optimum form of treatment (open or covered, dry or wet). Once blisters have broken, it is best to remove its ragged roof to decrease the possibility of secondary infection. Routine wound inspection aids in the early detection and institution of appropriate therapy for any complicating bacterial infections. Analgesics should be given as required. Skin grafting is rarely required and when it has been attempted, grafts have not taken well. The use of cytokines is undergoing further research.

40. In a recent review on the casualties from the Iran-Iraq conflict, it appeared that the healing process and the final outcome were more dependent on the severity of the initial lesion than on the treatment applied.

Respiratory Tract Lesions

41. Mild respiratory tract injury, with hoarseness and sore throat only, usually requires no treatment. Cough may be relieved by codeine. Laryngitis and tracheitis may be treated symptomatically with steam or sterile cool mist inhalations. If more severe respiratory tract injury is suspected, hospitalisation may be advisable. If a bacterial pneumonia occurs, isolation of the specific organisms with their antibiotic sensitivities should be performed, then antibiotic therapy can be limited to the specific agents.

Systemic Effects

42. Every effort should be made to maintain adequate metabolic status and to replace loss of fluids and electrolytes. Infection should be treated promptly and vigorously. The use of growth factors is the subject of on-going research.

Burns Caused by High Doses or Vapour

43. After exposure to a high dose of mustard vapour, especially under tropical conditions, nausea, vomiting and symptoms of collapse are usually evident before erythema develops completely. It is important to note that this occurs also among personnel who are masked during exposure. Constitutional symptoms may persist several days, during which burns will increase in severity. Cases of this type should be classed as casualties. Severe vapour burns of the trunk produce a generalised erythema but include pale grey areas that eventually vesiculate or become necrotic. It is common to see patches of unaffected skin as a result of protection by overlying equipment.

Burns Caused by Low Doses of Vapour

44. Mild vapour burns cause erythema, itching, and irritation but do not produce casualties. The medical officer should always consider the interval after exposure in relation to the severity of the burn. Mild lesions may represent early phases of severe exposure to vapour. When the period since exposure is uncertain, rapidity of development and the presence of constitutional symptoms may help to determine the severity.

Sensitisation due to Multiple Exposures to Mustard

45. Attention should be paid to the characteristic appearance of 're-exposure' burns. This manifestation may occur in individuals as a result of exposure to mustard 1 to three weeks (or more) previously. A small percentage of personnel will become sensitised to the agent and will react differently, both qualitatively and quantitatively, upon re-exposure. Sensitisation will be followed by a more rapid onset of symptoms upon re-exposure. Erythema, with or without oedema, and pronounced itching and burning usually appear within one hour. Lower

concentrations of mustard may produce effects in sensitised person than in a non-sensitised person. When erythema and oedema result from exposure to a low dose, they generally develop rapidly and subside within two to three days. Also, vesication resolves more rapidly in the sensitised person.

46. One of the most frequent manifestations of re-exposure in sensitised personnel is the development of a morbilliform rash. Another characteristic reaction is the appearance of eczematoid dermatitis surrounding old lesions, whether or not they are healed. This may last for several days and resembles dermatitis venenata (from poison ivy). Similar phenomena due to sensitisation have been known to occur with the nitrogen mustards.

Disposition of Casualties

47. Evaluation of lesions that have most generally led to disability of personnel exposed to blister agents during field trials and who subsequently participated in simulated combat exercises, obstacle course tests and marches, resulted in the following observations:

- Widespread vesication of the trunk produced casualties.
- Vesication localised in particular areas of the body produced casualties.
- Burns caused by high doses of the vapour to masked personnel, especially in tropical climates, are of casualty severity partly due to oedema and vesication of the skin and partly to constitutional reactions such as nausea, vomiting and prostration.
- Burns produced by doses of vapour low enough to cause only such skin reactions as mild erythema, oedema, burning and itching usually do not produce casualties.
- The stage of development of the lesion must be considered when classifying an individual as a casualty or non-casualty.
- The effects of mustard on particular areas of the body are explained below

Trunk and Neck

48. ***Extensive Vesication of the Trunk***—All the patients considered under this heading should be evacuated promptly. Important points to note are as follows:

- Extensive vesication may occur over a large part of the trunk. Intervening areas of skin may be erythematous with pin-point vesication. These burns are more likely to occur on the back than anteriorly.
- Some protection is afforded anteriorly by equipment such as webbing and ammunition pouches. The front of the uniform also gives some anterior protection because it does not cling to the body.
- Extensive vesication may be followed by fever, nausea and vomiting.
- These effects tend to occur more readily in tropical climates.

- Secondary bacterial infection may complicate the clinical course. The medical officer in a forward position is not likely to see infection of vesicated areas because such cases will have been evacuated before secondary infection develops.

49. Localised Vesication of the Trunk—Vesication occurring within the natal cleft (between the buttocks) usually requires evacuation of the casualty. Walking becomes difficult, defecation is painful and dressings require frequent changing. The lesion is usually most intense at the upper end of the cleft. Vesication of the buttocks usually results from sitting on contaminated ground or in contaminated trousers for prolonged periods. The vesicated area may extend forward across the perineum to involve the scrotum and the penis. Other points to note are as follows:

- Trivial burns, such as mild erythema affecting the natal cleft, are not of casualty severity. However, these burns require careful attention because walking or running aggravates the lesions and may break down injured skin.
- Single discrete blisters on the buttocks away from the natal cleft do not produce casualties.
- Blisters on the trunk generally require protective dressings to prevent friction due to clothing. The medical officer must decide whether dressings should remain in position during regular duty.

Arms

- 50.** Most personnel with blister agent injuries of the arms, when suitably treated, are permitted to continue with their duties. Vesication, when localised produces little or no disability.
- 51.** Extensive vesication involving the axillae and the elbows, volar or dorsal aspects, partially impairs the movement of the limbs at those joints. Oedema of the surrounding tissue tends further to immobilise the extremities. The dorsal aspects of the elbow and forearm are common sites of severe burns because these parts touch contaminated ground when personnel are firing in the prone position. Casualties of this type should be evacuated. Widespread vesication of the arms results in partial disability. Casualties of this type should be evacuated.

Hands

- 52.** Blister agent burns of the hands are often encountered. These burns tend to cause a degree of disability out of proportion to the size of the lesions. Considerable care and judgement are required in correct disposition.
- 53.** Experience in tropical experimental installations indicates that protective gloves and protective ointment provide adequate protection against high doses of vapour. Yet it is hard to avoid burns of the hands in a heavily contaminated jungle. The palms are more resistant to vesication but blisters affecting the

palms are characteristically painful and slow to heal. A solitary lesion of limited extent may result in little or no disability if treated properly.

54. Burns from *liquid* vesicant on the dorsum of the hand result in severe local reactions characterised by intense oedema of the backs of the hands and fingers. Pain is characteristic and is intensified by movement of the fingers or wrist. These patients should be regarded as casualties. An individual exposed within the previous 24 hours and reporting for treatment with apparently trivial blisters may be totally incapacitated the following day. Sharp erythema of the dorsum of the hand, with vesication beginning 12 to 24 hours after exposure, indicates a lesion that will progress to extensive vesication and oedema. Under such circumstances the individual should be evacuated when first seen. More commonly, the lesions consist of scattered small vesicles and limited areas of erythema. These lesions can be protected satisfactorily and the individuals returned to duty.
55. Exposure to vesicant vapour produces diffuse erythema of the dorsum of the hand and wrist. Higher doses cause oedema and vesication as well; patients of this type require evacuation.

The Lower Extremities

56. When the lower extremities are involved, the knees are the most common sites of burns from liquid vesicant. These lesions and those of the ankles often result in incapacitation by interfering with locomotion. Movement of joints tends to aggravate existing lesions by increasing oedema. A further disabling factor is introduced by the wearing of firm dressings applied to mobile joints. Vesication often spreads over the kneecaps, upward onto the thighs, and down toward the feet. These burns tend to be extensive and are associated with oedema often extending halfway up the thigh and down the leg. Medical officers should evacuate casualties with such lesions. In general, burns of the leg are more incapacitating than burns of the thigh.
57. It has been shown that the presence of many superficial blisters on the legs and thighs alone is not enough to make a person incapable of carrying out routine military duties. Individuals with such lesions, having suitable dressings, were able to take part in daily marches and routine gun drills. In disposing of these cases, the medical officer will consider the mental and physical status of the individual, their willingness to carry on, and the tactical situation at the time. Such patients are in the category of partial disability. After suitable dressings have been applied, personnel with high morale and robust physiques may be returned to duty.
58. A relatively small blister or group of blisters situated in the popliteal area may reduce the efficiency of a person so much that they may require evacuation. This is due to aggravation of the lesions by movement of the limbs and interference with ambulation. However, blisters affecting this area are not necessarily casualty-producing. (Inflammation, oedema, infection and lesions on other parts of the body should be considered when deciding upon the disposition of an individual). Available evidence indicates that the mustard

blister, size for size, is potentially more incapacitating than a blister from Lewisite. This results from the tendency of mustard blisters to be associated with erythema and oedema, while the Lewisite blister usually causes little local reaction.

59. Vesicant lesions also develop near the ankles at the tops of the shoes. Blistered areas occurring at such unprotected points are associated with severe pain due to circulatory impairment and tense oedema of the leg. These patients should be evacuated.
60. Vapour burns of the legs tend to be most aggravated in the popliteal spaces. Pin-point vesication is often found here. Higher doses cause intense erythema with scattered areas of vesication over the entire surface of the leg. Such lesions are invariably casualty producing and are generally accompanied by severe burns elsewhere, frequently with severe systemic effects. Mild vapour burns of the legs produce irritation and itching common to all widespread vapours burns. While these effects are troublesome, they are not casualty producing, and personnel so affected may be returned to duty.
61. Extensive vesication of the feet is uncommon. The soles are protected by shoes and are comparatively resistant to vesication. Burns on the dorsal aspect of the foot are often associated with local reactions like those seen on the backs of hands. Individuals with these burns, especially if widespread over the foot, find it difficult or impossible to wear shoes and will require evacuation. Small discrete blisters may be of non-casualty significance. These blisters may be effectively protected so as to allow wearing of shoes and walking with little discomfort.

The Genitalia

62. The genital region, in addition to the eyes and the respiratory tract, is highly sensitive to blister agent burns. In World War I such burns produced many casualties. The majority of these burns were caused by vapour. Despite present methods of protection against blister agents, including impregnated garments designed to protect the genitalia, medical officers (especially in tropical areas) may be confronted with many casualties with such burns.
63. Vapour is a more common cause of burns affecting the genitalia than liquid agent. Erythema may not be conspicuous. The most prominent feature of the burn is the oedema involving the penis and scrotum or labial region. Fluid accumulates most readily in the prepuce, distending its entire circumference and forming a characteristic semitranslucent ring around the corona. In more severe cases the entire body of the penis or labia become oedematous.
64. The lesions cause apprehension as well as physical discomfort. Occasionally vesication is superimposed on the oedema. Ulceration is not infrequent at the tip of the prepuce where it may become secondarily infected. In severe cases associated with marked oedema, retention of urine may result from both mechanical and reflex effects.

65. In mild cases, objective changes of the scrotum or labia often tend to pass undetected due to the normal pigmentation, elasticity, and looseness of the skin. Even considerable oedema may not be enough to reveal its presence. In severe cases the scrotum or labia may become grossly enlarged. The rugae may be partly or completely obliterated. Pin-point vesication may occur, usually after a lapse of a few days. The scrotal or labial skin tends to break down resulting in small painful ulcers and fissures.
66. Burning is the most prominent subjective symptom in involvement of the genitalia. Apprehension and anxiety are distressing during the presence of the objective changes described above. As oedema decreases, itching starts and may persist long after the acute effects have subsided. Sometimes this itching is intolerable. The scrotum or labia may continue to crack and ulcerate for a considerable period, causing pain and irritation. Mild exposure of the genital region characteristically is followed by a delay in the development of symptoms, often for as long as 4 to 10 days.
67. Patients with mild burns without oedema or vesication, but who complain of irritation and burning, may be safely returned to duty following treatment. In disposing of mild burns of the genitalia, the medical officers must assure themselves that the symptoms are not too early to be judged with finality. Severely affected individuals should be evacuated on the basis of the apprehension that may be suffered as well as the physical discomfort involved.

Systemic Effects of Cutaneous Burns

68. Systemic effects due to blister agents probably may be encountered with disabling skin lesions and lesions of the respiratory tract. The medical officer should be familiar with the signs and symptoms. These include anorexia, nausea, vomiting, depression and fever and are far more prone to occur in hot than in temperate climates. Malaise and nausea generally are the first reactions and may then progress either to mild, transient vomiting or to severe, persistent vomiting and retching. Anorexia may be the only complaint in mild reactions. The actual time of onset of symptoms is four to 12 hours after exposure and symptoms often occur before skin injury is manifest. No rule can be given for the duration of systemic symptoms, although personnel usually have recovered from severe vomiting within 24 to 26 hours. Anorexia and nausea may persist for a longer time. The temperature may remain elevated for several days. Mental depression may follow mustard burns and persist for several days. People with systemic reactions will generally be casualties, particularly in view of the probability of associated extensive skin burns. Such casualties should be evacuated quickly.

Secondary Bacterial Infection in Blister Agent Burns

69. This paragraph considers the problem of secondary bacterial infection after blister agent injuries only as it influences the disposition of affected personnel in forward positions. Secondary bacterial infection has often been cited as a common complication of mustard burns of the skin. Compared with the incidence of infection in thermal and traumatic wounds, indications are that the

incidence of sepsis in mustard lesions is remarkably low according to observations made at experimental installations.

70. Secondary infection becomes manifest several days after injury. Medical officers are not likely to see secondary infection with extensive blister agent burns in the front lines because severely affected patients should have been evacuated early. Infection of small lesions does not require evacuation. Infection of multiple lesions is likely to be an indication for evacuation, particularly if constitutional effects are associated. Infection is particularly disabling when it involves the feet, the hands, the genitalia or tissues overlying the joints of the limbs.
71. Secondary infection is more likely to occur in severe, rather than mild, vapour injury to the respiratory tract. Severe respiratory symptoms will almost invariably be associated with severe eye effects. Respiratory lesions may not develop for several days, and by then the individual is more likely to have been evacuated as an eye casualty. Secondary infection is uncommon as a sequel to mild degrees of mustard conjunctivitis and ordinarily would not prevent an individual from continuing duty. Mild conjunctival burns may be associated with pharyngitis, laryngitis, and tracheitis, increasing in severity for several days. Occasionally more extensive respiratory infection may ensue.

Time Course and Prognosis

72. As has already been stated, the great majority of mustard gas casualties survive. Resolution of specific problems can be difficult to predict but the following may provide a guide:
 - **Eye Lesions**—Most are resolved within 14 days of exposure.
 - **Skin Lesions**—Deep skin lesions may be expected to heal in up to 60 days. Superficial lesions heal in 14–21 days.
 - **Upper Respiratory Tract Lesions**—It is very difficult to define a time course for complete recovery. Recent experience with patients from the Iran-Iraq conflict during 1984–86 was that they were often discharged whilst still coughing and complaining of expectoration. Lung function tests on patients with purely upper respiratory tract lesions were usually normal on discharge. Patients with parenchymal damage often showed an abnormal pattern on lung function testing.

VESICANT INCIDENT—LEWISITE EFFECTS

General

73. General treatment guidelines are at Annex C. An antidote for Lewisite is dimercaprol [2,3-dimercapto-propanol, $\text{CH}_2\text{SH} - \text{CHSH} - \text{CH}_2\text{OH}$, BAL (British Anti-Lewisite)]. Purified dimercaprol is a colourless liquid, soluble one part in 15 parts of water and more soluble in peanut oil or in ethanol. It can combine with arsenic forming a water soluble complex that can be excreted. With arsenicals, the complex formed possesses a pentagon with two carbon atoms, two sulphur

atoms and one arsenic atom at the corners. This is the same mechanism by which Lewisite blocks two adjacent SH groups of pyruvate dehydrogenase system. The therapeutic action of dimercaprol can thus be explained by the law of mass action: dimercaprol provides the organism with a great number of adjacent SH groups that displaces the arsenic bound to enzymes. The enzymes are reactivated and can resume their normal biological activity. However, the toxicity of dimercaprol itself must be considered. It sometimes provokes local irritation.

Eyes

74. Dimercaprol eye ointment may diminish the effects of Lewisite if applied within two minutes of exposure. Its value is questionable if applied later than this. In severe cases, the systemic use of morphine may be necessary for control of pain. When the conjunctival oedema subsides enough to permit ophthalmic examination, the cornea should be stained with fluorescein to detect erosions and the iris should be examined for iritis. Atropine sulphate ointment should be instilled to obtain and maintain good mydriasis in all cases with corneal erosions, iritis cyclitis or with marked photophobia or miosis. Antibiotics may be used to combat infection. Sterile petroleum jelly (Vaseline) applied to the lid margins will help prevent their sticking together. Irrigations of the eye should be sparing, employing isotonic solutions. Occlusive dressings or pressure on the globe must be avoided.

Skin

75. Dimercaprol (British Anti-Lewisite (BAL)) ointment may be applied to skin exposed to Lewisite before actual vesication has begun. Any protective ointment already on the skin must be removed before application of BAL ointment because it may destroy the latter. BAL ointment is spread on the skin in a thin film and allowed to remain at least five minutes. Occasionally, BAL ointment causes stinging, itching or urticarial weals. This condition lasts only an hour or so and should not cause alarm. Mild dermatitis may occur if BAL ointment is frequently applied on the same area of skin; hence, this property precludes its use as a protective ointment. Dimercaprol is chemically incompatible with silver sulphadiazine and the two should not be used together.
76. Some blistering is inevitable in most arsenical vesicant cases which come to the Medical Services. The treatment of the erythema, blisters and denuded areas is identical with that for similar mustard lesions. A severe third degree burn involving a large surface area is similar to a thermal injury and must be managed by intravenous resuscitation to correct potential hypovolaemic shock. Morphine and splinting of the affected parts may be necessary to relieve pain. When the involved area is greater than 20 per cent of the body surface area, hospitalisation is indicated. Hospitalisation may be indicated when the involved area is less than 20 per cent when the depth of the skin involvement appears to be significant.

Systemic

77. Burns severe enough to cause shock and systemic poisoning are life-threatening. Even if the patient survives the acute effects, the prognosis must be guarded for several weeks.

Indication for Systemic Treatment

78. The indications for systemic treatment, following exposure to arsenical blister agents by any route are:

- cough with dyspnoea and frothy sputum, which may be blood tinged and other signs of pulmonary oedema;
- a skin burn the size of the palm of the hand or larger, caused by a liquid arsenical blister agent which was not decontaminated within the first 15 minutes; or
- skin contamination by a liquid arsenical vesicant covering five per cent or more of the body surface, in which there is evidence of immediate skin damage (grey or dead-white blanching of the skin), or in which erythema develops over the area within 30 minutes.

Types of Treatment

79. The following two types of treatment may be used:

- Local neutralisation on and within the skin by a liberal application of dimercaprol (BAL) ointment. The affected skin is to be left covered with a layer of ointment. Remove any other protective ointment before treatment with BAL ointment.
- Intramuscular injection of BAL in oil (10 per cent).

80. The maximum dosage of BAL is as follows: 3 mg/kg (200 mg for an average person) intramuscularly repeated every four hours for two days, every six hours on the third day and every 12 hours for up to 10 days. The injection must be by deep intramuscular injection: subcutaneous leakage must be avoided.

81. Dimercaprol when given by injection often produces alarming reactions including:

- increased systolic and diastolic pressure;
- tachycardia;
- nausea and vomiting;
- headache;
- burning sensation of lips;
- feeling of constriction of the chest;

- conjunctivitis;
- lachrymation;
- rhinorrhoea;
- sweating; and
- anxiety and unrest.

82. Despite these effects 'the cure is not worse than the disease' and they pass in a few hours. About 50 per cent of patients will experience such adverse reactions if 5 mg/kg doses of dimercaprol are given. Unless unduly severe or prolonged they do not contra-indicate the full course of treatment.

Newer Compounds

83. Dimercaprol is the current therapy for Lewisite poisoning. Newer chelating agents, however, have been developed and some look promising for systemic use. Before considering these it will be well to define the abbreviations;

- DMSA: meso-dimercaptosuccinic acid
- DMPS: 2,3-dimercapto-1-propanesulfonic acid
- Na: salt
- DMPA: N-(2,3-dimercaptopropyl)-phthalamidic acid

84. The main advantages of these compounds are that:

- they are water soluble, active when given orally and relatively non-toxic;
- they are substantially more effective systemically, using the therapeutic index as a measure;
- BAL produces mobilisation of arsenic from most tissues but is less effective in so doing than DMSA, DMPS and DMPA;
- BAL given to rabbits poisoned with sodium arsenite produced an increase in brain-arsenic levels. DMPA and DMPS on the other hand produced a marked fall in brain-arsenic levels;
- DMSA and DMPS have been identified as having an anti-Lewisite action.
- of the series DMPS, DMSA and BAL, when tested for capacity to reverse or prevent pyruvate dehydrogenase inhibition by sodium arsenite, DMPS proved the most potent and BAL the least potent drug.

85. The evidence then appears to support the contention that the more recently developed chelating agents should be considered as alternatives to dimercaprol in the treatment of systemic Lewisite poisoning. Detailed metabolic studies have not yet been performed on DMSA and DMPS and there is an urgent need for such work.

Course and Prognosis

86. The long-term effects of exposure to Lewisite are unknown.

VESICANT INCIDENT—PHOSGENE OXIME EFFECTS

Treatment

87. Treat as any other ulcerated necrotic skin lesion, (eg thermal burn) with due consideration of other supportive measures. Pulmonary oedema should be treated appropriately.

Course and Prognosis

88. Recovery takes one to three months.

OEDEMAGEN INCIDENT EFFECTS

General

89. Medical treatment guidelines for oedemagens is at Annex D. It is desirable that a casualty exposed to a lung-damaging agent be kept at rest until the danger of pulmonary oedema is past, but the operational situation may prevent this. Tightness of the chest and coughing should be treated with immediate rest and comfortable warmth. The casualty should be evacuated in a semi-seated position if dyspnoea or orthopnoea make a supine posture impractical. Mandatory evacuation by litter in cases of significant respiratory involvement has been advocated.

Sedation

90. Sedation should be used sparingly. Codeine in doses of 30 to 60 mg may be effective for cough. Restlessness may be a manifestation of hypoxia; therefore, only cautious use of sedatives is advised. Use of sedatives should be withheld until adequate oxygenation is assured and facilities for possible respiratory assistance are available. Barbiturates, atropine, analeptics and antihistamines are all contraindicated.

Oxygen

91. Hypoxaemia may be controlled by oxygen supplementation. Early administration of positive airway pressure (intermittent positive pressure breathing (IPPB), positive end-expiratory pressure (PEEP) mask or, if necessary, intubation with or without a ventilator) may delay and/or minimise the pulmonary oedema and reduce the degree of hypoxaemia.

Antibiotics

92. Antimicrobial therapy should be reserved for acquired bacterial bronchitis/pneumonitis. Prophylactic therapy is not indicated.

Steroids

- 93.** After exposure to a sufficiently high dose of phosgene or similar agent, pulmonary oedema will follow. Administration of corticosteroids has been recommended, but proof of their beneficial effects is lacking. It has been suggested that, when steroid treatment is initiated within a very short time of the exposure, this therapy may lessen the severity of the oedema. Two inhalational regimes are in use: one using dexamethasone and the other using betamethasone or beclomethasone. In either case, treatment should be started as soon as possible, ideally within 15 minutes of exposure. Doses of steroids used are much greater than those prescribed in asthma and when steroids are used they should be given in high doses by inhalation and in severe cases by injection.
- 94.** Rest, warmth, sedation and oxygen are of great importance, as indicated above. Treatment for exposure to a lung-damaging agent, or similar compound, except for zinc chloride smoke, for which an extended regimen is essential, should be judged on the basis of:
- precautionary treatment for what seems a mild but possibly dangerous exposure; and
 - definitive treatment for an exposure which is definitely expected to endanger life.

Course and Prognosis

95. During the acute phase, casualties may have minimal signs and symptoms and the prognosis should be guarded. Casualties may very rapidly develop severe pulmonary oedema. If casualties survive more than 48 hours they usually recover without sequelae.

BLOOD AGENT INCIDENT—CYANIDE EFFECTS

Treatment

96. Successful treatment for acute cyanide poisoning depends upon rapid fixation of the cyanide ion, either by methaemoglobin formation or by fixation with cobalt compounds. Any casualty who is fully conscious and breathing normally more than 5 minutes after presumed exposure to cyanide agents has ceased will recover spontaneously and does not require treatment, cyanide being very rapidly detoxified in the body. Artificial resuscitation, though possible, is not likely to be helpful in the absence of drug treatment. The treatment protocol is at Annex E.

Hydrogen Cyanide Poisoning

97. Management of cases of hydrogen cyanide poisoning divides into two parts:
- **First Aid Measures**—The casualty should be removed from the source of hydrogen cyanide. Rescue workers should wear adequate individual protective equipment.
 - **Therapy**—The key to treatment of patients poisoned with hydrogen cyanide is speed in instituting appropriate airway management and 100 per cent oxygen. Though disagreement regarding the ideal drugs for use in the treatment still occurs there is none regarding the need for urgent action.
98. Two major approaches are involved in the treatment of cyanide poisoning:
- **Provision of Binding Sites:**
 - Provision of binding sites for the cyanide ions. These sites provide alternatives to those of cytochrome oxidase and essentially reactivate that enzyme. Binding sites may be provided by drugs such as dicobalt edetate and by hydroxocobalamin or by the production of methaemoglobin in the blood. Methaemoglobin binds avidly to cyanide ions and may be produced by compounds such as sodium nitrite and amyl nitrite and dimethylaminophenol (DMAP). **Dicobalt edetate is not appropriate in this chaotic situation. Hydroxocobalamin is more appropriate.**
 - Methaemoglobin-forming compounds should be used cautiously in patients suffering from concurrent carbon monoxide poisoning or hypoxia.

- **Provision of Additional Sulphur Groups**—These enhance the detoxification of cyanide and thiocyanate by endogenous rhodanese. This is accomplished by giving sodium thiosulphate.

It is generally agreed that binding the cyanide ions is the first priority of treatment but that thiosulphate must be provided to permit conversion of the cyanide ions to thiocyanate.

Binding Cyanide Ions

99. The following compounds and drugs bind cyanide ions:

- **Compounds Producing Methaemoglobin:**
 - *Amyl Nitrite*—This is useful only in a closed positive pressure respiratory system. Crushing the ampoule around the face or even inside the facepiece of the respirator is inadequate. It should not be used with concurrent oxygen administration due to the risk of explosion. Treatment with amyl nitrite should be followed by sodium thiosulphate.
 - *Sodium Nitrite*.—This should be administered intravenously. Ten millilitres of a three per cent solution (300 mg) of sodium nitrite should be injected intravenously over a period of three minutes. The therapeutic index of sodium nitrite is very low; the above dose, indicated for adults has caused death in children. The sodium nitrite is given to produce methaemoglobin, thus sequestering the cyanide on the methaemoglobin. The cyanide is then removed from the body as thiocyanate after administration of sodium thiosulphate. The decrease in blood pressure following sodium nitrite injections is negligible unless the patient is allowed to get into an upright position. The development of a slight degree of cyanosis is evidence of a desirable degree of methaemoglobin formation (methaemoglobinaemia). It is not anticipated that at the above dosages an extreme or injurious degree of methaemoglobinaemia will develop. If it does, however, it should be treated by oxygen administration.
 - *4-Dimethylaminophenol-hydrochloride (DMAP)*—This has proved very effective in the treatment of cyanide poisoning owing to rapid formation of methaemoglobin (metHb). DMAP can be life saving, but not curative; intravenous thiosulphate is required for definitive cure. DMAP should be slowly injected intravenously in a dose of 250 mg. Muscular necrosis may follow intramuscular injection and the intramuscular route should be avoided. If sodium thiosulphate is not immediately available 250 mg of DMAP should be given every hour until thiosulphate can be given; this latter completes the treatment. It should be remembered that DMAP will cause cyanosis due to metHb formation. This indicates effective treatment and does not call for resuscitation. Where too much methaemoglobin has been formed, methylene blue may be given to convert methaemoglobin to haemoglobin.

- **Hydroxocobalamin**—Hydroxycobalamin (vitamin B12a) binds cyanide to form cyanocobalamin (vitamin B12). It must be given intravenously in large doses and it is not feasible to give it via any other route.
- **Dicobalt Edetate**—Dicobalt edetate given intravenously in doses of 600 mg (40 ml of a 1.5 per cent solution in glucose/water solution) has proved successful. The injection should be followed by an intravenous injection of sodium thiosulphate. It should be noted that cobalt edetate is toxic to the kidney and causes hypotension.

Provision of Sulphur Groups

- 100.** Sodium thiosulphate provides additional thiosulphate ions and these combine with cyanide ions under the influence of rhodanese to produce thiocyanate. It should be given to supplement any other form of treatment for cyanide poisoning. The dose is 12.5 g intravenously (50 ml of a 50 per cent solution) over a 10 minute period.

Additional Therapy

- 101.** Oxygen should be given if available.

Course and Prognosis

- 102.** Death may occur within minutes without treatment, but a casualty who is fully conscious and breathing normally five minutes after presumed exposure has ceased does not require treatment. Occasionally, where tissue hypoxia has been prolonged, residual injury of the CNS may persist for weeks and some damage may be permanent.

CYANOGEN HALIDES

Treatment

- 103.** Cyanogen halide poisoning should be treated in the same way as hydrogen cyanide poisoning as regards its cyanide-like effects. Pulmonary irritation should be treated in the same way as phosgene poisoning.

Course and Prognosis

- 104.** Recovery from the systemic effects of cyanogen halide poisoning is usually as prompt as in hydrogen cyanide poisoning. However, a higher incidence of residual damage to the central nervous system is to be expected. Depending on the concentration of cyanogen halide to which the casualty has been exposed, the pulmonary effects may develop immediately or may be delayed until the systemic effects have subsided. Early prognosis must, therefore, be guarded.

INCAPACITANT INCIDENT—BZ EFFECTS

Treatment

- 105.** For most casualties, symptomatic treatment is all that will be necessary. Firm restraint when necessary and a friendly attitude are called for especially in dealing with these subjects who are capable of walking. All dangerous objects must be removed and anything likely to be swallowed should be kept away from the subject as bizarre delusions may occur. Treatment protocols are at Annex F.

106. The most important single medical consideration is the possibility of heat stroke. Clothing should be removed if the temperature is greater than 25°C. If the body temperature is greater than 39°C vigorous cooling is indicated. The casualty should be placed in the shade and air allowed to circulate. Water may be sprayed on the casualty to aid cooling, ice should not be applied to the skin.
107. Physostigmine which is used as an antidote to BZ should be reserved for casualties who appear to be in danger. Where this treatment is deemed to be necessary an injection of 2–3 mg will be required to alleviate the condition. Repeated injections at intervals of approximately fifteen minutes to one hour may be required to build up a sufficient level. Once a desirable effect is achieved it should be maintained by slow intravenous injection or infusion. Doses of 2–4 mg every one or two hours may be required. The dose should be titrated against symptoms with gradual tapering of the dose as the effect of the poisoning runs its course. This may vary from a few hours to several days. Oral dosing should replace intravenous therapy as soon as possible (2–5 mg every one to two hours).
108. Peripherally acting drugs, which do not cross the blood-brain barrier, such as pyridostigmine, neostigmine and pilocarpine are ineffective antagonists of the central effects of BZ and should not be used in place of physostigmine.

INCAPACITANT INCIDENT—LSD EFFECTS

Treatment

109. No true antagonist to the indoles is as yet known. The best treatment known at present for LSD intoxication is the administration of diazepam 10–20 mg intravenously or intramuscularly or sodium amytal 200–400 mg intravenously to sedate the patient until spontaneous recovery occurs. Chlorpromazine has also been suggested but does not appear to have any advantage over these drugs **although it is a serotonin antagonist and LSD is a partial serotonin agonist.**

Course and Prognosis

110. The question of long term effects is still unresolved, but single exposures to doses in the clinical range (0.1 to 1.0 mg total dose) appear unlikely to cause any permanent biological damage.

RIOT CONTROL AGENT INCIDENT—LACHRYMATOR EFFECTS

Treatment

111. First aid and therapy are recommended as follows:

- **First Aid:**
 - In practically all cases it is sufficient to take the patient into fresh air where the symptoms will soon disappear. Clothing should be

changed. If symptoms persist the eyes, mouth and skin may be washed with water (and with soap in the case of the skin). Oil based lotions should not be used. Skin decontaminants containing bleach should not be used, but should be reserved for more dangerous contamination (eg vesicants or nerve agents) - bleach reacts with CS to form a combination which is more irritant to the skin than CS alone. Chest discomfort can usually be relieved by reassurance.

- CS hydrolyses more rapidly in alkaline solutions and an acceptable skin decontamination solution is 6.7 per cent sodium bicarbonate, 3.3 per cent sodium carbonate and 0.1 per cent benzalkonium chloride.

- **Therapy:**

- *Eyes*—Ordinarily, the eye effects are self-limiting and require no treatment. If large particles or droplets of agent have entered the eye, treatment as for corrosive materials may be required. Prompt irrigation with copious amounts of water is the best treatment for solid CS in the eye. After complete decontamination corticosteroid eye preparations may be used. Patients who have been heavily exposed must be observed for possible development of corneal opacity and iritis.
- *Skin*—Early erythema and stinging sensation (up to one hour), especially in warm moist skin areas, are usually transient and require no treatment. Inflammation and blistering similar to sunburn may occur after heavy or prolonged exposure, especially in fair skin. Acute contact dermatitis should be managed initially in the same way as any other acute dermatitis. Corticosteroid cream or calamine lotion may be applied to treat existing dermatitis or to limit delayed erythema. Oozing may be treated with wet dressings of 1 in 40 aluminium acetate solution for 30 minutes three times daily. A topical steroid should follow the wet dressing immediately. Secondary infection is treated with appropriate antibiotics. Significant pruritus can be treated with calamine lotion or corticosteroid preparations. If blisters develop these should be treated as any other second degree burn.
- *Respiratory Tract*—In the rare event of pulmonary effects from massive exposure evacuation is required. Management is the same as that for lung damaging agents.

Course and Prognosis

112. Most personnel affected by riot control agents require no medical attention and casualties are rare.

RIOT CONTROL INCIDENT—VOMITING AGENT EFFECTS

Treatment

113. Put on the protective mask and wear it in spite of coughing, sneezing, salivation and nausea. Lift the mask from the face briefly if necessary to permit vomiting or to drain saliva from the facepiece. Carry on with duties as vigorously as possible—this will help to lessen and shorten the symptoms. Combat duties usually can be performed despite the effects of vomiting agents.

114. In spite of the dramatic appearance of the syndrome, the only treatment necessary is first aid. The patient should not smoke for some hours. If necessary the mouth may be rinsed with water, but the water should not be swallowed. The eyes and skin may be washed with water. Clothing should be well brushed. In cases of severe exposure treatment as for lung damaging agent poisoning may be required. A mild analgesic may be given to relieve headache and general discomfort.

Course and Prognosis

115. Symptoms of exposure to field concentration of vomiting agents usually disappear in 20 minutes to two hours, leaving no residual injury. However, a few instances of severe pulmonary injury and death have occurred due to accidental exposure to high concentrations in confined spaces.

	GA	GB	GD	GF	VX
P2S		+			+
PRALIDOXIME		+			+
OBIDOXIME	+	+		+/	+
HI6	+/	+	+/	+	+

Table 1: Effectiveness of Various Oximes in the Treatment of Nerve Agent Poisoning

Degree of Poisoning	PAM Cl	P2S	Obidoxime
Mild	1 g	400 mg	250 mg
Moderate	1 g ^(a)	400 mg ^(b)	250 mg ^(c)
Severe	1 g ^(a)	500 mg ^(b)	250 mg ^(c)

Notes

- (a) *To be repeated every eight to twelve hours.*
- (b) *Second dose of 400 mg to 500 mg after thirty minutes. Further doses of 200 mg to 400 mg every four to twelve hours.*
- (c) *Second dose after two hours. Further doses to be repeated every six to twelve hours.*

Table 2: Examples of Current Dosing Schemes for the Intravenous Administration of Oximes

Oxime	Loading Dose (mg/kg-1)	Approximate Dose for 70 kg Person (mg)	Infusion Rate (mg/kg-1/h-1)	Approximate Rate for 70 kg Person (mg/h-1)
PAM Cl (pralidoxime)	4.2	300 (500mg/hr)	2.2	160
P2S	4.4	310	2.1	150
Obidoxime	0.8	56	0.5	34
HI6 ^(a)	1.6	110	0.8	54

Note

- (a) *Based on data from intramuscular administration.*
- (b) *Loading dose = therapeutic plasma concentration x volume of distribution.*
- (c) *Infusion rate = therapeutic plasma concentration x clearance.*

Table 3: Loading Doses and Infusion Rates for Oxime Administration to obtain a Plasma Concentration of 4 Mg/L-1.

NB: Refer to Chapter 5 paragraph 43 to refresh on the acrostic ASBESTOS.

Annexes:

- A. Medical Treatment Guidelines for Nerve Agent Poisoning
- B. Medical Treatment Guidelines for Mustard Poisoning
- C. Medical Treatment Guidelines for Lewisite Poisoning
- D. Medical Treatment Guidelines for Phosgene Poisoning
- E. Medical Treatment Guidelines for Hydrogen Cyanide or Cyanogen Chloride Intoxication
- F. Medical Treatment Guidelines for Poisoning by BZ and its Analogues

MEDICAL TREATMENT GUIDELINES FOR NERVE AGENT POISONING

1. Confirm decontamination with Chemical Agent Monitor (CAM).
2. Check prophylaxis and medication already given.
 - Combopen (UK): 500 mg pralidoxime mesylate, 10 mg avizafone, 2 mg atropine.
 - Combopen (Australian): 220 mg obidoxime, 2 mg atropine; atropine autoinjectors: 2 mg.
 - Mark 1 (US): 600 mg 2-PAM (pralidoxime) chloride, 2 mg atropine.
3. **Check that auto-injectors will be available to field teams for personal protection and +/- exposed persons in the hot zone.**
4. **Oxygenation and Ventilation**—Oxygen is required and this can be provided by oro-facial mask, if conscious. Ventilation may be needed and should be done via endotracheal airway. The need for ventilation may continue for half an hour to three hours.
5. **Atropine**—Give 2 mg IV at three to five minute intervals until signs of successful atropinisation are noted (increase in heart rate to 90 beats/minute, drying of salivary secretions, reduction of ventilatory resistance). When the intravenous preparation is available, the preferred route of atropine administration is via the intravenous route, but **care should be exercised as although needed to correct hypoxia, it may precipitate ventricular fibrillation**. In a hypotensive patient or a patient with poor veins, atropine may be given intramuscularly.
6. **Oximes**—The following oximes should be repeated for two or three additional doses:
 - Obidoxime (GA, GB, VX)—250 mg slowly IV. Second dose after two hours, then six to twelve hourly.
 - Pralidoxime Chloride (GB, VX)—The preferred method of administration of the oxime is by intravenous drip of 1 g over 20 to 30 minutes (more rapid administration will cause hypertension), but three additional oxime autoinjectors (total dose of 1.8 g) may be given if the intravenous route cannot be used. This may be given hourly up to a maximum of 4 g.
 - Pralidoxime Mesylate (GB, VX)—The preferred method of administration of the oxime is by intravenous drip of 400 mg over 20 to 30 minutes (more rapid administration will cause hypertension) with a second dose of 400–500 mg after 30 minutes. Further doses of 200–400 mg may be given every four to twelve hours.

- HI-6 (GA, GB, GD, GF)—The HI-6 should be given as a continuous infusion with a loading dose of 1.6 mg.kg^{-1} and an infusion rate of $0.8 \text{ mg.kg}^{-1}.\text{h}^{-1}$.
7. **Diazepam**—5 mg IV slowly at 15 minute intervals to stop convulsions. The intervals may be increased depending on the patients condition.
 8. Suction for bronchial, salivary secretions.
 9. ECG monitoring for arrhythmias.
 10. Catheter for bladder dysfunction. Hourly urine output should be at least 60 ml per hour.
 11. **Eyes**—Homatropine eye drops (to reduce pain and headache, has little effect on miosis).
 12. Correct acidosis.

MEDICAL TREATMENT GUIDELINES FOR MUSTARD POISONING

1. Check decontamination with CAM.
2. Any open wounds should be decontaminated with 3000 ppm Milton's Solution.
3. **Eyes:**
 - Irrigate with saline as soon as possible then daily.
 - Wash/cut eyelashes.
 - Homatropine (or other anticholinergic) drops bd for three to four days.
 - Chloramphenicol drops qid.
 - Vaseline to lid margins bd to prevent sticking.
 - Ice packs.
 - Local anaesthetic drops may be useful initially if blepharospasm is too severe to permit an adequate examination, but topical analgesics should otherwise be avoided and systemic analgesics should be given for eye pain.
 - Dark glasses.
 - Reassurance that patient is not blind.
4. **Skin:**
 - Erythema should be treated with calamine or other soothing lotion or cream (eg 0.25 per cent camphor and menthol, calamine) to reduce burning and itching.
 - Debride non-viable skin.
 - Small blisters (1–2 cm) should be left intact.
 - Drain blisters > 2 cm in diameter and use their tops as a dressing.
 - Denuded areas should be irrigated three to four times daily with saline, another sterile solution, or soapy water and then liberally covered with a topical antibiotic such as silver sulfadiazine or mafenide acetate to a thickness of 1–2 mm.
 - Potent analgesia should be used liberally, particularly before manipulation of the patient or irrigation of the burn areas.
 - Monitoring of fluids and electrolytes is important but is not of the magnitude seen with thermal burns and clinicians must not overhydrate the patient.

- Antihistamines, calamine lotion and topical steroids for pruritus.
- Reserve systemic antibiotics for actual infections.
- Daily bath.

5.

Respiratory Tract:

- Intubation should be performed early before laryngeal spasm or oedema makes it difficult or impossible. Intubation permits better ventilation and facilitates suction of the necrotic and inflammatory debris. Oxygen may be needed, and early use of CPAP, IPPV and possibly PEEP may be of benefit.
- Upper airway symptoms (sore throat, non-productive cough, hoarseness) may respond to steam inhalation and cough suppressants (Codeine linctus).
- Irrigation of nasal, oral and pharyngeal cavities with normal saline.
- Antibiotics (avoid those likely to produce bone marrow depression) should be given after positive signs of infection (usually about the third day after exposure).
- Bronchodilators may be of benefit for bronchospasm.

6. Gastrointestinal:

- Atropine (0.4–0.6 mg, i.m. or IV), another anticholinergic drug, or antiemetic should control the early nausea and vomiting. Prolonged vomiting or voluminous bloody diarrhoea beginning several days after exposure suggests direct involvement of the gastrointestinal tract by severe systemic poisoning, a poor prognostic sign.

7. Bone Marrow:

- Sterilisation of the gut by non-absorbable antibiotics should be considered to reduce the possibility of sepsis from enteric organisms in those with marrow suppression.
- Opportunistic infections secondary to immunosuppression may occur. In at risk patients with a fever, a beta-lactamase resistant penicillin, an aminoglycoside and metronidazole, should be given. The use of systemic anti-fungals should be considered.
- GM-CSF, 240 mg per square metre body surface area given IV over two hours daily until the WCC responds, should be considered. Other interleukins and conjugates may be considered.

8. General:

- Acute systemic problems may be seen in individuals exposed to very high doses. These symptoms should be treated as for cardiogenic shock.
- Circulation support to replace loss of fluids and electrolytes.
- Potent analgesia.
- Daily WCC.

MEDICAL TREATMENT GUIDELINES FOR LEWISITE POISONING

1. Check decontamination with CAM.
2. **Eyes:**
 - Irrigate with saline as soon as possible then daily.
 - Wash/cut eyelashes.
 - Dimercaprol (BAL) five per cent drops (use ampoules) as soon as possible then bd. The drops will be painful initially.
 - Homatropine (or other anticholinergic) drops bd for three to four days.
 - Chloramphenicol drops qid.
 - Vaseline to lid margins bd to prevent sticking.
 - Ice packs.
 - Local anaesthetic drops may be useful initially if blepharospasm is too severe to permit an adequate examination, but topical analgesics should otherwise be avoided and systemic analgesics should be given for eye pain.
 - Dark glasses.
 - Reassurance that patient is not blind.
3. **Skin:**
 - Erythema should be treated with calamine or other soothing lotion or cream (eg 0.25 per cent camphor and menthol, calamine) to reduce burning and itching.
 - Dimercaprol ointment may be applied to skin exposed to Lewisite before actual vesication has begun. Any metal-containing protective ointment already on the skin must be removed before application of BAL ointment because it may destroy the latter. BAL ointment is spread on the skin in a thin film and allowed to remain at least five minutes. Occasionally, BAL ointment causes stinging, itching or urticarial weals. A topical anti-histamine may be needed. This condition lasts only an hour or so and should not cause alarm.
 - Debride non-viable skin.
 - Small blisters (1–2 cm) should be left intact.
 - Drain blisters > 2 cm in diameter and use their tops as a dressing.
 - Denuded areas should be irrigated three to four times daily with saline, another sterile solution, or soapy water and then liberally covered with a

topical antibiotic such as silver sulfadiazine (SSD) or mafenide acetate to a thickness of 1–2 mm. Care should be taken in the vicinity of the eye as dimercaprol drops will chelate the silver in SSD.

- Potent analgesia should be used liberally, particularly before manipulation of the patient or irrigation of the burn areas. Splinting may be necessary.
- Reserve systemic antibiotics for actual infections.
- Daily bath.

4. Respiratory Tract:

- Intubation should be performed early before laryngeal spasm or oedema makes it difficult or impossible. Intubation permits better ventilation and facilitates suction of the necrotic and inflammatory debris. Oxygen may be needed, and early use of CPAP, IPPV or PEEP may be of benefit.
- Upper airway symptoms (sore throat, non-productive cough, hoarseness) may respond to steam inhalation and cough suppressants (Codeine linctus).
- Irrigation of nasal, oral and pharyngeal cavities with normal saline.
- Antibiotics should be given after positive signs of infection (usually about the third day after exposure).
- Bronchodilators may be of benefit for bronchospasm.

5. Systemic Treatment:

- The indications for systemic treatment following exposure by any route are:
 - Cough with dyspnoea and frothy sputum, which may be blood tinged and other signs of pulmonary oedema.
 - A skin burn the size of the palm of the hand or larger, caused by a liquid arsenical blister agent which was not decontaminated within the first 15 minutes.
 - Skin contamination by a liquid arsenical vesicant covering five per cent or more of the body surface, in which there is evidence of immediate skin damage (grey or dead-white blanching of the skin), or in which erythema develops over the area within 30 minutes.
- Where indicated the systemic treatment is an intramuscular injection of BAL in peanut oil (10%). This should be given as 3 mg.kg^{-1} (200 mg for an average person) intramuscularly repeated every four hours for two days, every six hours on the third day and every twelve hours for up to ten days. The injection must be by deep intramuscular injection: subcutaneous leakage must be avoided. Dimercaprol when given by injection often produces alarming reactions but these will pass in a few hours. Unless

unduly severe or prolonged, they do not contra-indicate the full course of treatment.

General

6. Monitoring of fluids and electrolytes is important as in severe cases shock may develop. This must be managed by intravenous resuscitation. Care must be taken not to overhydrate the patient.

MEDICAL TREATMENT OF GUIDELINES FOR PHOSGENE POISONING

- 1. Rest and Warmth**—Whilst desirable that a casualty be kept at rest until the danger of pulmonary oedema is past, the operational situation may prevent this. Tightness of the chest and coughing should be treated with immediate rest and comfortable warmth. The casualty should be evacuated in a semi-seated position if dyspnoea or orthopnoea make a supine posture impractical.
- 2. Respiratory:**
 - **Oxygen**—Hypoxaemia should be controlled by oxygen supplementation. Early administration of positive airway pressure or, if necessary, intubation with or without a ventilator, may delay and/or minimise the pulmonary oedema and reduce the degree of hypoxaemia. Positive pressure may need to be applied during at least the end-expiratory phase of the ventilator cycle.
 - **Suction**—Airway secretions need to be suctioned.
- 3. Bronchodilators**—Bronchospasm may occur in individuals with reactive airways and beta-adrenergic bronchodilators should be used.
- 4. Steroids**—Steroid therapy is also indicated for bronchospasm as long as parenteral administration is chosen over topical therapy, which may result in inadequate distribution to damaged airways. Methylprednisolone 1000 mg or its equivalent may be given in divided doses (IV) for the first three days and then tapered, with a pulsed alternate day treatment. during the duration of the clinical illness.
- 5. Hypotension**—Sequestration of plasma-derived fluid in the lungs may cause hypotension, which may be exacerbated by positive airway pressure. Urgent intravenous fluid resuscitation may be needed. Judicious use of the pneumatic anti-shock garment may be considered.
- 6. Antibiotics**—should be reserved for those patients with an infectious process documented by sputum gram staining and culture. Prophylactic therapy is not indicated.
- 7. Sedation**—Sedation should be used sparingly. Codeine in doses of 30 to 60 mg may be effective for cough. Use of sedatives should be withheld until adequate oxygenation is assured and facilities for possible respiratory assistance are available.
- 8. Corticosteroids**—These can inhibit the inflammatory response and should be considered in severe cases. Beclomethasone aerosol should be given as 10 puffs stat, 5 puffs hourly for 24 hours and then 3 puffs three hourly for three days. In all cases, treatment should be started as soon as possible, ideally within 15 minutes of exposure. Doses of steroids used are much greater than

those prescribed in asthma and when steroids are used they should be given in high doses by inhalation and in severe cases by injection.

www.ema.gov.au